

RM OF TACHE

ENVIRONMENT ACT PROPOSAL
WASTEWATER TREATMENT LAGOON
EXPANSION

COMMUNITY OF LORETTE

AUGUST 2015

WASTEWATER TREATMENT LAGOON EXPANSION COMMUNITY OF LORETTE

RM of Taché

Environment Act Proposal Report

Project No. 151-01887-00
Date: August 2015

—
WSP Canada Inc.
1600 Buffalo Place
Winnipeg, MB R3T 6B8 Canada

Phone: +1-204-477-6650
Fax: +1-204-474-2864
www.wspgroup.com





August 5, 2015

Ms. Tracey Braun, M.Sc.
Director, Environmental Approvals
MANITOBA CONSERVATION AND WATER STEWARDSHIP
160-123 Main Street
Winnipeg, MB R3C 1A5

Subject : Environmental Act Proposal – R.M. of Taché – Community of Lorette – Wastewater Treatment Lagoon Expansion

Dear Ms. Braun,

The Rural Municipality of Taché – Community of Lorette has an existing four-cell wastewater stabilization pond operating under Environment Act Licence No. 2439, dated January 14, 2000. Dictated by growth within the Community, the existing facility requires additional treatment and storage capacity. The major items of the proposed development are a new treatment and storage cell as well as a phosphorus removal system.

The enclosed Environment Act Proposal report (4 copies, 1 CD) provides the details and information of the proposed development. It is accompanied by the signed application form, an application for Wastewater Treatment Facility Classification and a cheque in the amount of \$7,500.00. We request the opportunity to review the draft Environment Act Licence when it is issued. Please contact the undersigned if further information is required.

Kind regards,

A handwritten signature in black ink, appearing to read 'J. Bunn', is written over a light blue horizontal line.

Jason Bunn, P.Eng.
Environmental Engineer

WSP Canada Inc.
1600 Buffalo Place
Winnipeg, MB R3T 6B8 Canada

Phone: +1-204-477-6650
Fax: +1-204-474-2864
www.wspgroup.com

SIGNATURES

PREPARED BY



Jason Bunn, P.Eng.
Environmental Engineer



REVIEWED BY



Ross Webster, P.Eng.
Manager, Environmental Group



EXECUTIVE SUMMARY

Leading up to this Environment Act Proposal (EAP), WSP most recently completed a review of the community wastewater treatment capacity and a pre-design report for the expansion of Lorette's wastewater treatment lagoon for the R.M. of Taché. With Council's agreement on a plan for expansion, the R.M. of Taché desired to move forward without delay to the preparation and submission of this EAP report.

The existing wastewater treatment lagoon, is located east and south of the Community of Lorette and consists of two aerated primary (treatment) cells and two secondary (storage) cells, receiving wastewater from a sewer collection system within the Community. Considering the existing capacities of the lagoon and the anticipated growth within Lorette, expansion of the existing wastewater facility is required.

The expansion was not designed on the basis of a 20 year projection, but rather on utilizing the available land to provide the maximum serviceable population with a desired minimum of 6,000 people. Maximizing the available areas resulted in the expanded lagoon providing an organic loading (treatment) capacity for a population of 9,000 and a hydraulic loading (storage) capacity for a population of ±7,500.

Based on supporting information, the proposed development involves the construction of two new cells to increase the treatment and storage capacity of the lagoon facility with clay core type liners. Consideration of the phosphorus limit that will be imposed on the treated effluent led to the proposed implementation of a chemical dosing and cloth filter disk system, complete with backwash ponds. Other system upgrades are called for as part of the expansion project. The new facility will maintain the existing discharge pipe into the Seine River Diversion. The planned continuous seasonal discharge will be from June 15 through to November 1 or periods within.

Upon approval from Manitoba Conservation and Water Stewardship and the issuance of an Environment licence, it is anticipated that the tender and construction will begin in the spring of 2016.

TABLE OF CONTENTS

1	DEVELOPMENT INFORMATION.....	1
1.1	CANADIAN ENVIRONMENTAL ASSESSMENT INFORMATION.	2
2	DESCRIPTION OF DEVELOPMENT	3
2.1	LEGAL DESCRIPTION AND OWNERSHIP	3
2.2	MINERAL RIGHTS.....	4
2.3	DESCRIPTION OF EXISTING LAND USE.....	4
2.4	PREVIOUS STUDIES.....	4
3	EXISTING WASTEWATER TREATMENT LAGOON....	5
3.1	DESCRIPTION	5
3.2	EXISTING CAPACITY.....	5
3.2.1	TREATMENT CAPACITY.....	5
3.2.2	STORAGE CAPACITY	6
3.3	DISCHARGE ROUTE.....	7
4	POPULATION SERVICED AND DESIGN LOADING ...	8
4.1	SOURCES OF WASTEWATER.....	8
4.2	POPULATION	8
4.3	ORGANIC LOADING	8
4.4	HYDRAULIC LOADING	9
4.5	NUTRIENT LOADING	9
5	PROPOSED DEVELOPMENT.....	11
5.1	SITE CONDITIONS	11
5.1.1	LOCAL TOPOGRAPHY.....	11
5.1.2	SOIL CONDITIONS	11
5.1.3	GROUNDWATER.....	12
5.1.4	SITE INVESTIGATION	12
5.2	DESCRIPTION OF PROPOSED DEVELOPMENT	12

5.2.1	NEW AERATED PRIMARY CELL	12
5.2.2	NEW SECONDARY CELL.....	13
5.2.3	EXISTING SECONDARY CELLS.....	14
5.2.4	AERATION SYSTEM UPGRADES	15
5.2.5	PHOSPHORUS REMOVAL SYSTEM.....	15
5.2.6	EFFLUENT QUALITY	16
5.2.7	SUMMARY.....	16
6	ENVIRONMENTAL IMPACTS.....	19
6.1	ODOUR CONSIDERATIONS	19
6.2	LAND IMPACT	19
6.3	SURFACE WATER	19
6.3.1	FUEL STORAGE ON SITE.....	19
6.4	GROUNDWATER.....	20
6.5	SPECIES IMPACT	20
6.6	FISHERIES	20
6.6.1	FISHERIES ACT INFORMATION	20
6.7	FORESTRY	20
6.8	HERITAGE RESOURCES	21
6.9	SOCIO-ECONOMIC IMPACTS.....	21
6.10	PUBLIC INVOLVEMENT	21
7	MANAGEMENT PRACTICE.....	22
7.1	OPERATION.....	22
7.1.1	COMMISSIONING	22
7.1.2	DISCHARGE.....	22
7.1.3	BACKWASH AND SLUDGE.....	23
7.1.4	MAINTENANCE, RECORD KEEPING AND INSPECTION	23
8	SCHEDULE AND FUNDING	25
9	REFERENCES.....	26

TABLES

TABLE 1.1	PROPOSAL CONTENTS
TABLE 1.2	CEAA PROPOSAL CONTENTS
TABLE 3.1	EXISTING AERATED PRIMARY CELL PARAMETERS
TABLE 3.2	EXISTING SECONDARY CELL PARAMETERS
TABLE 4.1	NUTRIENT LOADING
TABLE 5.1	PRELIMINARY DESIGN SPECIFICATIONS FOR THE PROPOSED AERATED PRIMARY CELL
TABLE 5.2	PRELIMINARY DESIGN SPECIFICATIONS FOR THE PROPOSED SECONDARY CELL
TABLE 5.3	EXISTING SECONDARY CELLS – PROPOSED PARAMETERS
TABLE 5.4	EXPANDED WASTEWATER TREATMENT LAGOON CAPACITIES

FIGURES

FIGURE 2.1	LOCATION MAP OF THE EXISTING AND PROPOSED DEVELOPMENT
FIGURE 3.1	EFFLUENT DISCHARGE ROUTE FROM THE LORETTE LAGOON
FIGURE 5.1	PROCESS FLOW DIAGRAM
FIGURE 8.1	SCHEDULE - EAP SUBMISSION TO END OF CONSTRUCTION

APPENDICES

APPENDIX A	STATUS OF TITLE
APPENDIX B	EXISTING ENVIRONMENT ACT LICENCE
APPENDIX C	GEOTECHNICAL REPORT
APPENDIX D	PLANS AND DETAILS
APPENDIX E	GENERAL CORRESPONDENCE FOR REFERENCE

1 DEVELOPMENT INFORMATION

R.M. of Taché – Community of Lorette – Wastewater Treatment Lagoon Expansion

Name of development

R.M. of Taché

Legal name of the proponent of the development

River Lot 8, Parish of Lorette

Location of development

Contact Person for Proponent:

Ms. Christine Hutlet
Chief Administrative Officer
R.M. of Taché
Box 100, 1294 Dawson Road
Lorette, MB, R0A 0Y0

Contact Person for Environmental Assessment:

Mr. Jason Bunn, P.Eng.
WSP
1600 Buffalo Place
Winnipeg, MB R3T 6B8

TABLE 1.1: PROPOSAL CONTENTS

Section of Environmental Act Proposal Form		Section Number in Report
DESCRIPTION OF DEVELOPMENT:		
(i)	Legal description and map of development	2.1
(ii)	Mineral rights	2.2
(iii)	Existing land use	2.3
(iv)	Land use designation	2.3
(v)	Previous studies	2.4
(vi)	Proposed development	5.0
(vii)	Storage of gasoline or associated products	6.3.1
(viii)	Potential impacts	6.0
(ix)	Proposed environmental management	7.0
SCHEDULE:		8.0
FUNDING:		8.0

1.1 CANADIAN ENVIRONMENTAL ASSESSMENT INFORMATION

TABLE 1.2: CEAA PROPOSAL CONTENTS

Screening Report Outline		Section Number in Report
1.	Assessment Responsibility - Funding	8.0
2.	Project Description	
	2.1 General	2.0, 4.0, 5.0
	2.2 Project Components	5.2
	2.3 Construction Details	5.2
	2.4 Project Scoping	4.0
3.	Description of Environment	
	3.1 Land Uses and Ownership	2.1, 2.2, 2.3
	3.2 Local Soils, Topography, Geology	5.1
	3.3 Hydrology / Hydrogeology	6.3, 6.4
	3.4 Vegetation Communities	6.5
	3.5 Fish, Wildlife, and Habitat	6.5, 6.6, 6.7
	3.6 Endangered or Threatened Species	6.5
	3.7 Historic and Cultural Sites	6.8
4.	Environmental Impacts and Mitigation	
	4.1 Water Quality	6.3
	4.2 Odour	6.1
	4.3 Fisheries	6.3, 6.6
	4.4 Wetland / Wildlife Habitat	6.3
	4.5 Soils and Vegetation	6.2, 6.5
	4.6 Heritage Resources	6.8
	4.7 Navigable Waters	6.3
5.	Cumulative Effects	6.0
6.	Public Involvement	6.10
7.	Follow-Up	7.0
8.	Contacts	1.0
9.	Personal Communication	Appendix E
10.	Attachments	Appendix A, B, C, D, E

2 DESCRIPTION OF DEVELOPMENT

2.1 LEGAL DESCRIPTION AND OWNERSHIP

The existing wastewater treatment lagoon is located on a southern portion of River Lot 8 in the Parish of Lorette. The R.M. of Taché is the registered owner of the existing lagoon land, as identified in Status of Title No. 1712839/1. Specifically, this area of ownership is Public Works Plan 4196 Winnipeg Land Titles Office (WLTO), including the land south of the TransCanada Pipelines right-of-way (Plan 32221 WLTO) and north of the road and water control works (Plan 7768 WLTO).

The new development is to be located on the available land adjacent to the existing lagoon facility on the northwest and south sides within River Lot 8, as shown in Figure 2.1. According to Status of Title No. 1712839/1, the R.M. of Taché is the registered owner of the land proposed for development. The aforementioned Status of Title is included in Appendix A.

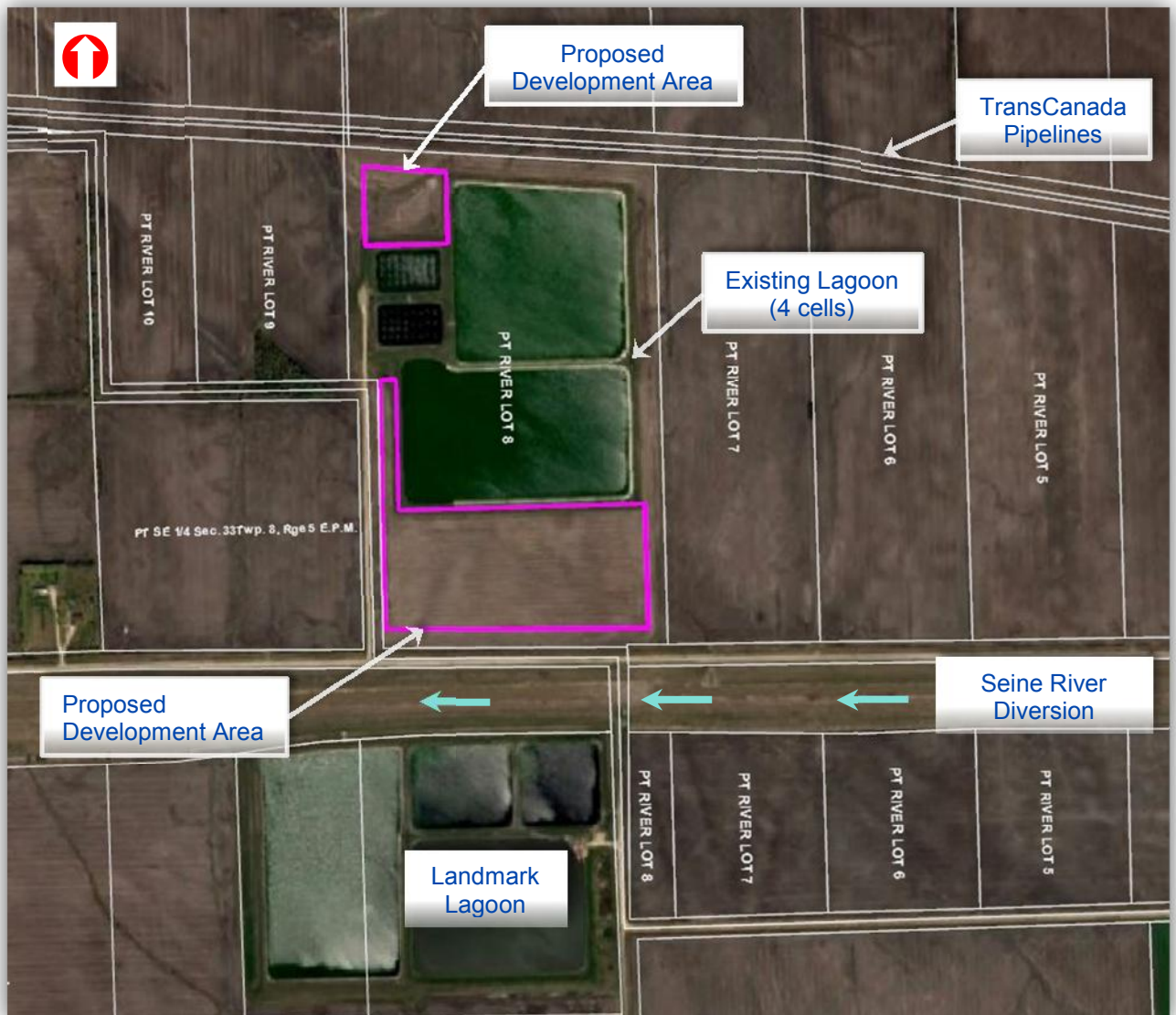

FIGURE 2.1: LOCATION MAP OF THE EXISTING AND PROPOSED DEVELOPMENT

2.2 MINERAL RIGHTS

The Crown Lands and Property Agency – Lands Branch was contacted to provide information on the mines & minerals and sand & gravel ownership of the applicable lands discussed in the previous section. The mines & minerals and sand & gravel were granted with the original title in 1884 and have remained with the surface title. Correspondence is included in Appendix E.

2.3 DESCRIPTION OF EXISTING LAND USE

Through information provided by the R.M. of Taché, the existing lagoon land and the land intended for lagoon development are designated as “General Agriculture Area” and zoned “AG”, Agriculture General Zone. Zoning Bylaw Map One for the R.M. of Taché illustrating the land zoning is included in Appendix E.

The existing lagoon is surrounded by agricultural land and is bordered on the north by four underground high pressure gas mains within the TransCanada Pipelines right-of-way. South of the southern limit of the RM property in River Lot 8 (Parish of Lorette) is Diversion Road, the Seine River Diversion and then the Landmark lagoon, respectively.

2.4 PREVIOUS STUDIES

2015 ***Geotechnical Report: “Proposed R.M. of Taché (Lorette) WWSP Expansion” prepared by WSP for the R.M. of Tache***

→ This report provides a detailed geotechnical investigation of the proposed development site conducted by WSP on April 17, 2015. The investigation included testhole drilling, sample collection and laboratory testing. The report concluded that based on soil conditions, the proposed expansion should be constructed with a clay core tied into the underlying high plasticity clay. The slope stability analysis confirmed that the new aeration cell and secondary cell are to be constructed with a 5:1 interior dyke slope. The report also recommends a tankage foundation for the phosphorus removal system.

2014 ***“Pre-Design Report – R.M. of Tache – Community of Lorette – Wastewater Stabilization Pond Expansion - DRAFT” prepared by WSP for the R.M. of Tache***

→ This report identifies the wastewater generation attributable to the Community of Lorette and the remaining treatment and storage capacities of the lagoon. With a goal of expanding the existing lagoon to service a population of 6,000 people, the construction of a new aerated primary cell and new secondary cell are both necessary. A brief discussion regarding the phosphorus removal options concludes with the proposal of a Nelson Environmental Cloth Disk Filter System to achieve this end. The opinion of probable cost the proposed expansion inclusive of the new cells, phosphorus filtration equipment and building, new aeration system and upgrades and engineering fees totals \$2.38 M CAD.

1999 ***“Proposed Minor Alteration – Environmental Act Licence No. 1989 RR – Proposed Lorette Wastewater Stabilization Pond” prepared by Cochrane Engineering for the R.M. of Tache***

→ In 1994 an Environment Act Proposal was submitted for the construction of a new lagoon for the Community of Lorette. Project implementation was deferred and this minor alteration report was submitted in 1999 proposing to move the lagoon to where it was eventually constructed and change the traditional primary treatment cell into two mechanically aerated cells.

1994 ***“Village of Lorette – Proposed Wastewater Stabilization Pond” prepared by Poetker MacLaren***

→ Submitted to the Environmental Management Division, this Environment Act Proposal report presented the population, wastewater loading and design details involved in the proposed three cell lagoon facility to be constructed in SW 33-8-5 EPM for Lorette.

3 EXISTING WASTEWATER TREATMENT LAGOON

3.1 DESCRIPTION

The existing licence directing lagoon operation is Environment Act Licence No. 2439, dated January 14, 2000. The lagoon was constructed at this time. The licence is attached in Appendix B.

The existing wastewater treatment lagoon is 5 kilometres south of Lorette and 2 kilometres west of Provincial Road 206 just to the north of Diversion Road. Constructed and commissioned in 2000, the lagoon serves the Community of Lorette. This lagoon does not receive truck-hauled septage or wastewater. It consists of two aerated primary cells and two secondary cells. The lagoon is connected to the sewer system via a lift station and forcemain which was twinned in 2014. Discharge of treated effluent is by buried pipe into the Seine River Diversion.

3.2 EXISTING CAPACITY

The existing Lorette lagoon has two mechanically aerated primary treatment cells connected in series and two secondary storage cells that collectively function in the treatment and storage of the Community's wastewater. Information regarding the actual dimensions and elevations of the existing lagoon was based on the 2002 "Revised" As Constructed Drawings and data from Cochrane Engineering.

The ability of a lagoon to treat the incoming wastewater is a measure of organic loading capacity. Organic loading refers to the quantity of organic material present in the incoming wastewater and is measured as the five day Biochemical Oxygen Demand (BOD₅). The organic loading becomes the total mass of BOD₅ in kg/d in the wastewater discharged to the lagoon. The wastewater from piped collection system areas are consistent on a year-round basis and do not have a seasonal variation.

The ability of a lagoon to store the incoming wastewater is a measure of its hydraulic loading capacity. Hydraulic loading refers to the volume of sewage flow to the lagoon. Wastewater treatment lagoons are presently designed for a 227-day storage period beginning November 1st and ending June 15th of the following year. Hydraulic loading over the 227-day storage period is used to calculate the volume of storage required in the lagoon facility.

3.2.1 TREATMENT CAPACITY

Most lagoons in the Province of Manitoba have conventional facultative primary treatment cells. Justification for the selection of conventional primary cells is found in the availability of land within the Province and the limited costs associated with an acceptable amount of treatment that conventional primary cells provide. Mechanical treatment of wastewater comes at a cost, albeit at a reduced footprint.

The move to mechanical treatment is usually triggered by a large population base or high strength wastewater that requires more intensive treatment. However, in the case of the Lorette wastewater treatment lagoon, the move to mechanically aerated primary cells when the lagoon was constructed was based on the concerns expressed by some of the area residents, with respect to the potential for odour.

The existing mechanically aerated primary cells provide treatment to the incoming wastewater. Sizing of the current aeration system was based on the calculated organic loading from the incoming wastewater.

The aerated primary cells were designed for a daily organic loading of **279 kg-BOD₅/day**. On the basis of accepted practice, the daily BOD₅ production for domestic wastewater collected via a piped system is 0.077 kg per person. Thus, the existing primary cells have the treatment capacity for a population of 3,623.

Table 3.1 lists the relevant information concerning the existing primary cells. Aerated primary cells do not contribute to the hydraulic storage of a wastewater treatment facility. The two cells combined provide a hydraulic retention time of 46 days.

TABLE 3.1: EXISTING AERATED PRIMARY CELL PARAMETERS

Parameter	Aerated Primary Cell No. 1	Aerated Primary Cell No. 2
Cell Bottom Dimensions	83.4± x 45.0± m	85.0± x 46.0± m
Liquid Surface Dimensions (at operating depth)	112.2± x 73.8± m	113.8± x 74.8± m
Operating Depth	3.6 m	3.6 m
Freeboard Height	1.0 m	1.0 m
Interior Side Slope	4 H : 1 V	4 H : 1 V
Total Volume (at operating depth)	20,841 m ³	21,363 m ³
Hydraulic Retention Time	~23 d	~23 d
Liner System	Clay core	Clay core

3.2.2 STORAGE CAPACITY

As the existing aerated primary cells do not contribute to the storage of the wastewater, the existing secondary cells provide the entirety of the storage capacity.

According to the original Environment Act Proposal Report submission, sizing of the secondary cells was based on providing storage for the volume of wastewater anticipated to be generated by an equivalent design population of 3,630 people, over the 227-day winter storage period. This wastewater generation corresponds to 250 litres per person per day (Lpcd).

Table 3.2 lists the relevant information concerning the existing secondary cells.

TABLE 3.2: EXISTING SECONDARY CELL PARAMETERS

Parameter	Secondary Cell 1	Secondary Cell 2
Cell Bottom Dimensions	Irregular	Irregular
Liquid Surface Dimensions (at operating depth)	Irregular	Irregular
Operating Depth	1.50 m	1.50 m
Freeboard Height	1.0± m	1.0± m
Interior Side Slope	4 H : 1 V	4 H : 1 V
Total Volume (at operating depth)	105,485 m ³	108,333 m ³
Deadspace height – actual*1	0.20 m	0.00 m
Deadspace volume – actual*1	13,625 m ³	0 m ³
Storage Volume – actual*1	92,627 m ³	108,333 m ³
Liner System	Clay core	Clay core

*1 deadspace based on the discharge pipe inverts from the As Constructed Drawings

Calculation of the storage volume for a secondary cell is subject to the deadspace volume in the bottom of the cell. The deadspace volume is simply the liquid volume in the bottom of a cell beneath the invert of the discharge pipe. Therefore, this liquid cannot be gravity discharged. Typical of our current design standards, discharge pipes are set at 0.3 m above the floor of the cell. However, in the case of the Secondary Cell 1 and 2, the discharge pipes are approximately 0.20 m and 0.00 m above the floor, respectively.

The current total lagoon storage capacity is $(92,627 + 108,333 =) 200,960 \text{ m}^3$.

Even though the deadspace in Secondary Cell 1 is lower than our design standards, it is acceptable. However, the discharge pipe invert in Secondary Cell 2 will require raising as part of the construction activities.

3.3 DISCHARGE ROUTE

The lagoon secondary cells are typically discharged over the course of the allowable discharge period from June 15 to October 31. The effluent is discharged from the existing cells into a 375 mm diameter buried outfall pipe that flows into the Seine River Diversion. The distance from the discharge point into the Seine River Diversion to the Red River is approximately 18.5 km. The discharge route is illustrated in Figure 3.1.

The existing and proposed lagoon facility is in the Seine River Diversion Watershed (No. 8).

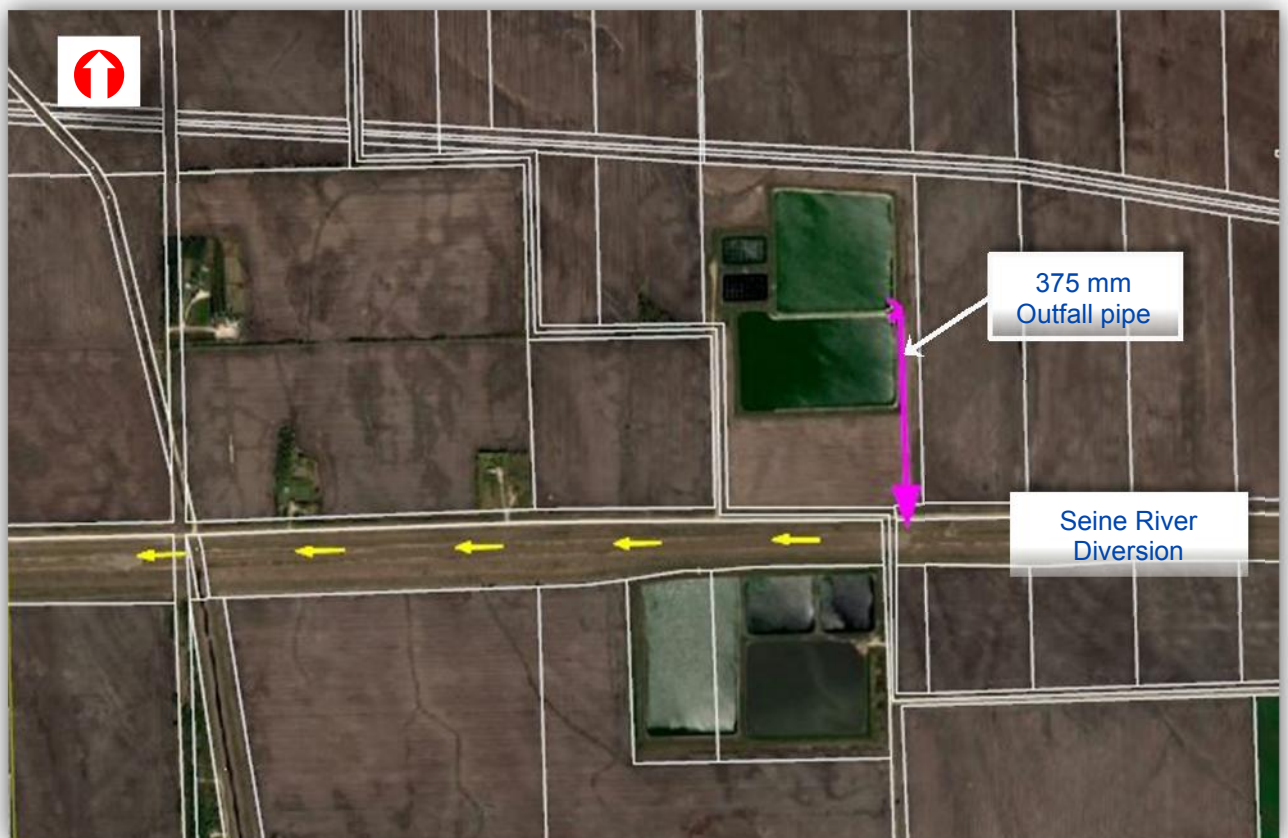

FIGURE 3.1: EFFLUENT DISCHARGE ROUTE FROM THE LORETTE LAGOON

4 POPULATION SERVICED AND DESIGN LOADING

4.1 SOURCES OF WASTEWATER

The existing Lorette lagoon services only the domestic wastewater from the Community of Lorette. There are no significant industrial or high strength contributors. No truck-hauled wastewater is received at the Lorette lagoon. Truck-hauled wastewater generated within the municipality is directed towards the Landmark lagoon.

4.2 POPULATION

Statistics Canada 2011 census data shows the population for the Community of Lorette to be 2,361. The current (2015) population of the Community of Lorette is approximately **2,900 people**, according to information provided by the R.M. of Taché.

In addition to the serviced residents, the Community sewer system serves bussed-in students. Typically in calculating wastewater flow we use a ratio of 3:1 (3 bussed-in students are equivalent to 1 person in a dwelling). However, the RM of Taché is in the Capital Region and it is well established that there is a daily commute of people that travel into the City of Winnipeg or the City of Steinbach. Therefore, conservatively, the commuter dynamic cancels out the impact of the bussed-in-students.

During this expansion, the R.M. of Taché desires to provide wastewater treatment for a population of at least 6,000 people by using their available land around the existing facility. Maximizing the available areas resulted in the expanded lagoon providing an organic loading (treatment) capacity for a population of 9,000 and a hydraulic loading (storage) capacity for a population of $\pm 7,500$, which is dependent of the wastewater generation rate at the time.

4.3 ORGANIC LOADING

As defined in Section 3.2, organic loading refers to the quantity of organic material present in the incoming wastewater and is measured as the five day Biochemical Oxygen Demand (BOD₅). The wastewater from the piped collection system areas are consistent on a year-round basis and do not have a seasonal variation.

On the basis of accepted practice, the daily BOD₅ production for domestic wastewater collected via a piped system is 0.077 kg per person. With a current (2015) population of 2,900, the organic loading to the existing Lorette lagoon is **223.3 kg-BOD₅/d**.

As stated in Section 3.2, the existing aerated primary cells of the lagoon provide an organic loading capacity of 279 kg-BOD₅/d.

Therefore, the existing primary cells are operating at 80% capacity and have adequate treatment capacity for the present and future loadings, up to a population of 3,623 people. Additional treatment capacity must be added to service the wastewater generation beyond this population.

Outside septic and/or holding tank loading need not be considered for this lagoon, as previously stated in Section 4.1.

4.4 HYDRAULIC LOADING

As defined in Section 3.2, hydraulic loading refers to the volume of sewage flow to the lagoon. Wastewater facilities are presently designed for a 227-day storage period beginning November 1st and ending June 15th of the following year. Hydraulic loading over the 227-day storage period is used to calculate the volume of storage required in the lagoon facility.

The existing lift station that receives the wastewater collected in the Community is a precast below-ground facility built in 2005. There are two submersible Flygt CP3201HT180 47 hp units.

WSP previously reviewed in detail the wastewater flow data obtained from the R.M. of Taché for the period of January 2009 to October 2013. Our review uncovered inconsistencies between the volumes of wastewater calculated using the pump run hour meters and the lift station magnetic flow meter. The data showed the magnetic flow meter volume to be higher than the volume calculated using the pump run hour meters.

Further lift station testing and more in-depth analysis of the data and pumps concluded that the error lies with the magnetic flow meter. A pump rate of 65 L/s was settled on. Using this pump rate, the average volume pumped to the lagoon over the last three (full) storage periods from 2011-2014 was 123,349 m³. This volume equates to a per capita flow of 206 Lpcd, which includes infiltration. As development continues within the Community, we anticipate that this wastewater generation rate will decrease.

With a current (2015) population of 2,900, the hydraulic loading to the existing Lorette lagoon is **135,610 m³**.

As stated in Section 3.2, the existing secondary cells of the lagoon provide a current hydraulic loading capacity of 200,960 m³.

Therefore, the existing secondary cells are operating at 67% capacity and have adequate storage capacity for the present and future loadings, up to a population of 4,297 people. Additional storage capacity must be added to service the wastewater generation beyond this population.

Outside septic and/or holding tank loading need not be considered for this lagoon, as previously stated in Section 4.1.

4.5 NUTRIENT LOADING

Based on a 2001 Government of Canada Report 2001 "*Nutrients and their impact of the Canadian environment*" the following assumptions were incorporated to approximate the nutrient loading to lagoon facilities:

Influent total phosphorus (TP) = 3.38 g/capita/d, with an removal efficiency of 65.5%
 Influent total nitrogen (TN) = 10 g/capita/d, with an removal efficiency of 10%

These values represent the nutrient loading in the domestic wastewater directed to a wastewater treatment lagoon facility. According to the report, a conventional facultative lagoon has a removal efficiency of 65.5% of the total phosphorus and 10% of the total nitrogen.

The above loading rates and removal efficiencies were used to calculate the yearly loading rates for the current and design populations, as well as the anticipated nutrient loading to the environment, post chemical and filter treatment (Table 4.1). For this table, the design population is considered to be 7,500, as it is the lower population value in terms of organic and hydraulic capacity.

TABLE 4.1: NUTRIENT LOADING

Population	Per Capita Nutrient Loading [g/capita/d]		Daily Nutrient Loading to Lagoon [kg/d]		Yearly Nutrient Loading to Lagoon [kg/y]		Lagoon Removal Efficiency [%]		Nutrient Loading - discharged from Storage Cells [kg/y]		Nutrient Loading - discharged from Filter [kg/y]	
	TP	TN	TP	TN	TP	TN	TP	TN	TP	TN	TP	TN
2,900	3.38	10	9.8	29.0	3,577	10,585	65.5	10	1,234	9,527	218*	9,527
7,500			25.4	75.0	9,271	27,375			3,198	24,638	564*	24,638

*Based on a 1 mg/L total phosphorus limit in the treated effluent released to the environment

5 PROPOSED DEVELOPMENT

Rather than sizing the expanded lagoon for a 20-year life, the proposed expansion involves utilizing the current land available to provide wastewater treatment for a maximum population in terms of both organic and hydraulic capacity.

The proposed development consists of:

- new aerated primary cell
- new blowers to replace the existing units
- replacement of worn components on the existing aeration system
- blower building upgrades
- electrical upgrades
- level control structure (weir manhole)
- new secondary cell
- raising secondary cell 2 discharge invert elevation
- phosphorus removal system complete with chemical dosing, cloth disk filter and tankage
- backwash ponds (3)
- manholes, piping, valves
- erosion repair of the applicable dyke sections for both existing secondary cells

The EAP design drawings are appended (Appendix D). The expansion work is to be completed while the facility remains in operation.

The expanded lagoon will provide adequate organic loading (treatment) capacity for a population of 9,000 people and hydraulic loading (storage) capacity for a population of $\pm 7,500$ people, dependent on the wastewater generation rate at the time. In the interim, the storage capacity of the expanded lagoon will actually be 6,100 people and when the need arises, the operating depth of Secondary Cell 3 will be increased from 2.1 m to 3.0 m depth. At this time, aeration will be incorporated into this cell. A notice of alteration will be submitted to Manitoba Conservation and Water Stewardship when this upgrade is made.

5.1 SITE CONDITIONS

On April 17, 2015 WSP conducted a geotechnical investigation at the proposed development area during which a drill rig was used to drill a total of 11 testholes (TH1 to TH11) between 4.6 m and 12.2 m depths below grade. The complete Geotechnical Report is included in Appendix C.

5.1.1 LOCAL TOPOGRAPHY

The proposed site is located on an area known as the Red River Plain sub-area. The Red River Plain sub-area is a clay basin, with local flood plains and river levees, which occupies the flat areas in the lower-lying part of the Lake Agassiz basin. The area consists of lacustrine clay and alluvial deposits which range from a few metres to 15 m or more in thickness. Limestone bedrock below thick clay and till layers (see the attached nearest well logs River Lot 8, Parish of Lorette) underlies much of the surficial deposits below a 19.8 m depth.

5.1.2 SOIL CONDITIONS

The general soil profile reveals a topsoil layer of about 100 mm to 200 mm followed by a thick clay layer, which extended to the bottom of the testholes at 12.2 m below grade. Testholes TH3, TH5, TH7 and TH9 are an exception to the general soil profile. In these testholes a silty clay layer was encountered at 0.6 m down to a 3.3 m depth.

No seepage and caving conditions were observed from the testholes. A detailed description of the soil profile is presented in the testhole logs, Appendix C (Geotechnical Report).

5.1.3 GROUNDWATER

There is a preliminary groundwater report prepared by the Planning Branch of the Water Resources Division for the RM of Taché. Based on the well logs and the synopsis, nearly the whole district is underlain by a carbonate rock (limestone and dolostone) aquifer that, in turn, is underlain by a sandstone aquifer. The well logs indicate a notable yield of 1.26 L/s to 3.2 L/s with the quality of water ranging from fair to excellent. The water is shown to be used for both livestock and domestic consumption. A review of the Groundwater Pollution Hazard Map shows that the property is located outside a groundwater pollution hazard area.

Based on the drainage map of the area, the local groundwater flow at the site is south towards the Seine River Diversion.

5.1.4 SITE INVESTIGATION

As classified during the field investigation, the clay layer encountered at the site is not consistent. For this reason, hydraulic conductivity of the in-situ clay at approximately 1 m below grade was tested. Some areas consist of silt inclusions between 0.6 m and 3.3 m below grade as shown by TH3, TH5, TH7 and TH9. Since some areas do not show any silt inclusions, the clay at a 1.5 m depth (TH8) is representative of the high plasticity clay. Due to this reason, hydraulic conductivity of the in-situ clay at 1.5 m depth (TH8) was tested.

The clay material at the 1.5 m depth is a CL/CH material based on the Atterberg Limit test. The estimated hydraulic conductivity of this material should range between 10^{-7} to 10^{-9} cm/s. The actual hydraulic conductivity of the in-situ clay obtained at the 1.5 m depth for TH8 was **2.64×10^{-9} cm/s**.

5.2 DESCRIPTION OF PROPOSED DEVELOPMENT

The following sections describe the construction and modifications proposed for the development. No changes are proposed for the existing wastewater collection system or the lift stations within the Community of Lorette.

The lagoon cell construction is based on the information and recommendations provided in the 2015 Geotechnical Report. Organic soil from the lagoon cell areas to be developed will be stockpiled and reapplied at the end of construction on the applicable disturbed areas and on the dykes as shown in the drawings.

For disturbed areas where sediment or erosion control is deemed necessary, the contractor will be required to employ appropriate measures.

5.2.1 PROPOSED AERATED PRIMARY CELL

The proposed aerated primary cell will be constructed as illustrated in the EAP design drawings (Appendix D) and will be located to the north of the existing primary cell and south of the TransCanada high pressure gas mains. The 400 mm diameter forcemain installed in 2014 in anticipation of this project will be extended into this new cell and the use of the existing 300 mm diameter forcemain will be suspended until increased wastewater flows necessitate its use.

The proposed cell is designed with a 2.0 m (min.) wide clay core that ties into the existing clay core, where appropriate. The clay core, situated in the middle of the dyke, shall have a permeability of 1×10^{-7} cm/s or less, meeting the Manitoba Conservation and Water Stewardship (CWS) guidelines. The remainder of the

dykes will be constructed with in-situ material. All embankments will be constructed in 150 mm lifts compacted to 95% Standard Proctor Dry Density.

An OPTAER fine bubble aeration system designed and installed by Nelson Environmental Inc. will provide the necessary aeration to the proposed cell. Construction involves the installation of a new HDPE header pipe from the existing aeration building to the new cell and floating laterals with suspended membrane diffusers.

The proposed cell will be constructed with 5:1 interior side slopes and 4:1 exterior side slopes and will have a normal operating depth of 3.6 metres with a minimum 1.0 metre freeboard. The interior dykes will be armoured with rip rap to prevent erosion. Table 5.1 provides the details for the preliminary design specifications for the Proposed Aerated Primary Cell.

The new three cell aeration system will be capable of providing treatment to a population of 9,000 if it was ever required, which corresponds to an organic loading of **693 kg-BOD₅/d**.

Perimeter ditching will be maintained and extended around the new cell, as required.

TABLE 5.1: PRELIMINARY DESIGN SPECIFICATIONS FOR THE PROPOSED AERATED PRIMARY CELL

Parameter	Proposed Primary Cell
Cell Bottom Dimensions	Irregular
Liquid Surface Dimensions (at operating depth)	Irregular
Operating Depth	3.6 m
Freeboard Height	1.0 m
Interior Side Slope	5 H : 1 V
Exterior Side Slope	4 H : 1 V
Total volume (at operating depth)	36,307m ³
Hydraulic Retention Time (pop. 7,500)	23.5 days
Liner system	Clay core

At the back end of the three aerated primary cells a level control structure will be constructed to maintain the liquid levels in these cells. The level control structure will allow the primary treated effluent to be directed to any of the three secondary cells, increasing the operational flexibility of the lagoon system.

5.2.2 PROPOSED SECONDARY CELL

The Proposed Secondary Cell (3) will be constructed as illustrated in the design drawings (Appendix D) and will be located south of existing secondary cell 2, bordered by Diversion Road to the south.

As with the proposed primary cell, this cell is designed with a 2.0 m (min.) wide clay core around the outside perimeter of the proposed new dykes that ties into the existing perimeter clay core. The clay core shall have a permeability of 1×10^{-7} cm/s or less. The remainder of the dykes will be constructed with in-situ material. All embankments will be constructed in 150 mm lifts compacted to 95% Standard Proctor Dry Density.

This cell is designed to provide the maximum storage within the area that is available.

Since the proposed secondary cell is preceded by aerated primary cells, it is permissible and beneficial for it to operate at a 2.1 m liquid depth. This new cell will be constructed with a 2.1 m operating depth (with a minimum 1.0 metre freeboard) and still be able to operate in conjunction with the existing two secondary cells, with discharge into the Seine River Diversion. The interior dykes will be armoured with rip rap to prevent erosion.

Due to the depth of the cell it will be constructed with 5:1 interior side slopes and 4:1 exterior side slopes. The cell will be constructed to allow for minimal earthworks to operate the cell at a 3.0 m operating depth when the population of the Community justifies this move which would also include providing aeration in this cell. Table 5.2 provides the details for the preliminary design specifications for the Proposed Secondary Cell (3) and its future capacity when aerated and operating at 3.0 m.

TABLE 5.2: PRELIMINARY DESIGN SPECIFICATIONS FOR THE PROPOSED SECONDARY CELL

Parameter	Proposed Secondary Cell (3)	Future Capacity of Proposed Secondary Cell (3)
Cell Bottom Dimensions	Irregular	Irregular
Liquid Surface Dimensions (at operating depth)	Irregular	Irregular
Operating Depth	2.1 m	3.0 m
Freeboard Height	1.0 m	1.0 m
Interior Side Slope	5 H : 1 V	5 H : 1 V
Exterior side slope	5 H : 1 V	5 H : 1 V
Total volume (at operating depth)	121,066 m ³	180,114 m ³
Dead storage volume (at 0.3 m depth)	15,901 m ³	15,901 m ³
Storage volume	105,165 m ³	164,213 m ³
Liner system	Clay core	Clay core

5.2.3 EXISTING SECONDARY CELLS

The discharge pipe invert on secondary cell 2 currently sits right at the bottom of the cell. The invert of this pipe will be raised between 0.2 and 0.3 metres off the bottom of the cell. The most probable fix is to install an elbow on the end of the pipe complete with a joint restraint.

There are segments of unarmoured dykes on both of the existing secondary cells that over the years have experienced erosion and now require restoration. This work will not be completed concurrently with the lagoon expansion as it will be best undertaken after the new storage cell is completed. It will require lowering of each secondary cell, allowing for time to dry out the cell bottoms. Once conditions are favorable, the either the eroded or new material will be used to reconstruct the dykes, followed by the placement of geotextile fabric and rip rap. If the expansion construction is completed in 2016, then the reconstruction of the eroded areas will likely occur in 2017 and may extend into 2018 if only one secondary cell can be repaired each year.

Table 5.3 provides the details for the proposed change to Secondary Cell 2.

TABLE 5.3: EXISTING SECONDARY CELLS – PROPOSED PARAMETERS

Parameter	Secondary Cell 1	Secondary Cell 2
Cell Bottom Dimensions	Irregular	Irregular
Liquid Surface Dimensions (at operating depth)	Irregular	Irregular
Operating Depth	1.50 m	1.50 m
Freeboard Height	1.0± m	1.0± m
Interior Side Slope	4 H : 1 V	4 H : 1 V
Total Volume (at operating depth)	106,252 m ³	108,333 m ³
Deadspace height – proposed	0.20 m	0.30 m
Deadspace volume – proposed	13,520 m ³	20,864 m³
Storage Volume – proposed	92,627 m ³	87,469 m³
Liner System	Clay core	Clay core

5.2.4 AERATION SYSTEM UPGRADES

The existing aeration system will require upgrades. Three new 60 hp blowers will be installed replacing the existing units, with two operating and one on standby. Any components of the existing aeration system that have reached the end of their service or functional life will be replaced new. Upgrades are also required in the existing blower building including a 400A service and modifications to the air intakes.

5.2.5 PHOSPHORUS REMOVAL SYSTEM

The Community of Lorette already exceeds a population of 2,000 and will need to implement a process within their lagoon system to meet the requirements of the *Water Quality Standards, Objectives and Guidelines Regulation* under *The Water Protection Act (2011)*. The R.M. of Taché (for the Lorette lagoon) will meet the 1.0 mg/L total phosphorus limit by implementing chemical dosing and a cloth disk filter system.

Phosphorus removal will be performed in newly constructed tankage at the southeast corner of the site. The system will receive wastewater as it is discharged from the secondary cells. Chemical precipitation and flocculation of orthophosphate will be performed by dosing aluminum sulfate or ferric chloride into a rapid mix chamber followed by a slow mix chamber and the flocculate will be filtered from the wastewater using a cloth disk filter (see Appendix D drawings). The filtrate (treated effluent) will be discharged by gravity into the existing outfall pipe that terminates in the Seine River Diversion. Aluminum sulfate or ferric chloride will be evaluated regarding their phosphorus removal performance.

Three backwash ponds will be constructed to allow the filter reject to settle for eventual dewatering and removal. At the design flows (7,500 pop., 206 Lpcd), each backwash pond has a hydraulic retention of approximately 9.5 days, if a 2% backwash flow is anticipated. Liquid overflow from the backwash ponds will be directed back into the system. On an as required basis, sludge will be removed and landfilled from the backwash ponds.

Since the system operates only during June through October a building is not necessary, however a final decision will be left to the detailed design phase of the work. Regardless, the chemical storage tanks will be housed in a suitably sized building. The entire phosphorus removal system will be surrounded within an extended perimeter fence.

There are two options for bringing electricity to this new system. There is a 3 phase distribution line running along Diversion Road and a new service could be established from this line. However, since Manitoba Hydro has already established a service for this property, the full costs of bringing in a new service would be borne by the R.M. of Taché. The second option is to trench an electrical cable running from the existing blower building. Both options will be evaluated at the detailed design stage.

A new access road will be constructed to the area of the phosphorus removal system. The road will also facilitate access to the backwash ponds for the purpose of sludge removal.

5.2.6 EFFLUENT QUALITY

To date, there have been no uncommon issues in the RM of Taché's ability to meet the discharge requirements of their existing Environment Act Licence. As discussed, we anticipate a 1.0 mg/L phosphorus limit to be applied to the facility and have implemented a demonstrated nutrient reduction strategy to meet this limit.

According to the Federal Wastewater Systems Effluent Regulations (WSER), the Lorette wastewater treatment lagoon is considered an *Intermittent Wastewater System* as it has a hydraulic retention of at least 90 days discharging at most four periods per calendar year.

This type of wastewater system treatment lagoon must manage the release of the following deleterious substances:

- (a) carbonaceous biochemical oxygen demanding matter;
- (b) suspended solids;
- (c) total residual chlorine; and
- (d) un-ionized ammonia.

The discharge of treated effluent must comply with the following conditions:

- (a) the average carbonaceous biochemical oxygen demand due to the quantity of CBOD matter in the effluent did not exceed 25 mg/L;
- (b) the average concentration of suspended solids in the effluent did not exceed 25 mg/L;
- (c) the average concentration of total residual chlorine in the effluent did not exceed 0.02 mg/L, if chlorine, or one of its compounds, was used in the treatment of wastewater; and
- (d) the maximum concentration of un-ionized ammonia in the effluent was less than 1.25 mg/L, expressed as nitrogen (N), at $15^{\circ}\text{C} \pm 1^{\circ}\text{C}$.

These parameters already appear in recently issued Environment Act Licences, bringing greater order and unity to the Provincial and Federal standards. WSER also calls for acute lethality testing on the discharging treated effluent, with the sampling frequency dependent on the annual average daily volume.

The effluent quality will also be restricted to a fecal coliform limit, as indicated by the MPN index, of 200 per 100 mL.

There is little concern that a well maintained lagoon system will have issues with meeting any of these conditions, with the exception of the phosphorus limit. With the use of mechanical treatment and a phosphorus removal system, the effluent quality is expected to meet all federal and provincial requirements.

5.2.7 SUMMARY

After expansion, the Lorette lagoon will be a six-cell lagoon. Three aerated primary cells will provide adequate treatment for a population of 9,000 people, while three secondary cells will provide storage for a population of 6,100 in the interim and $\pm 7,500$ people when the need arises. Table 5.4 summarizes the expanded lagoon capacities. Figure 5.1 illustrates the process flow through the expanded lagoon system.

TABLE 5.4: EXPANDED WASTEWATER TREATMENT LAGOON CAPACITIES

Cell Type	Liquid Surface Area [ha]		Total Volume [m ³]		Dead Storage Volume [m ³]		Storage Volume [m ³]	
Primary Cell 1 (<i>new cell</i>)	1.39		36,307		--		--	
Primary Cell 2	0.76		18,043		--		--	
Primary Cell 3	0.79		19,202		--		--	
Secondary Cell 1	7.40		106,252		13,625		92,627	
Secondary Cell 2	7.56		108,333		20,864		87,469	
Secondary Cell 3 (<i>new cell – 2.1m & 3.0m operating depths shown</i>)	6.32	6.81	121,065	180,114	15,901	15,901	105,165	164,213
Total	24.22	24.71	409,202	468,251	50,390	50,390	285,261	344,309

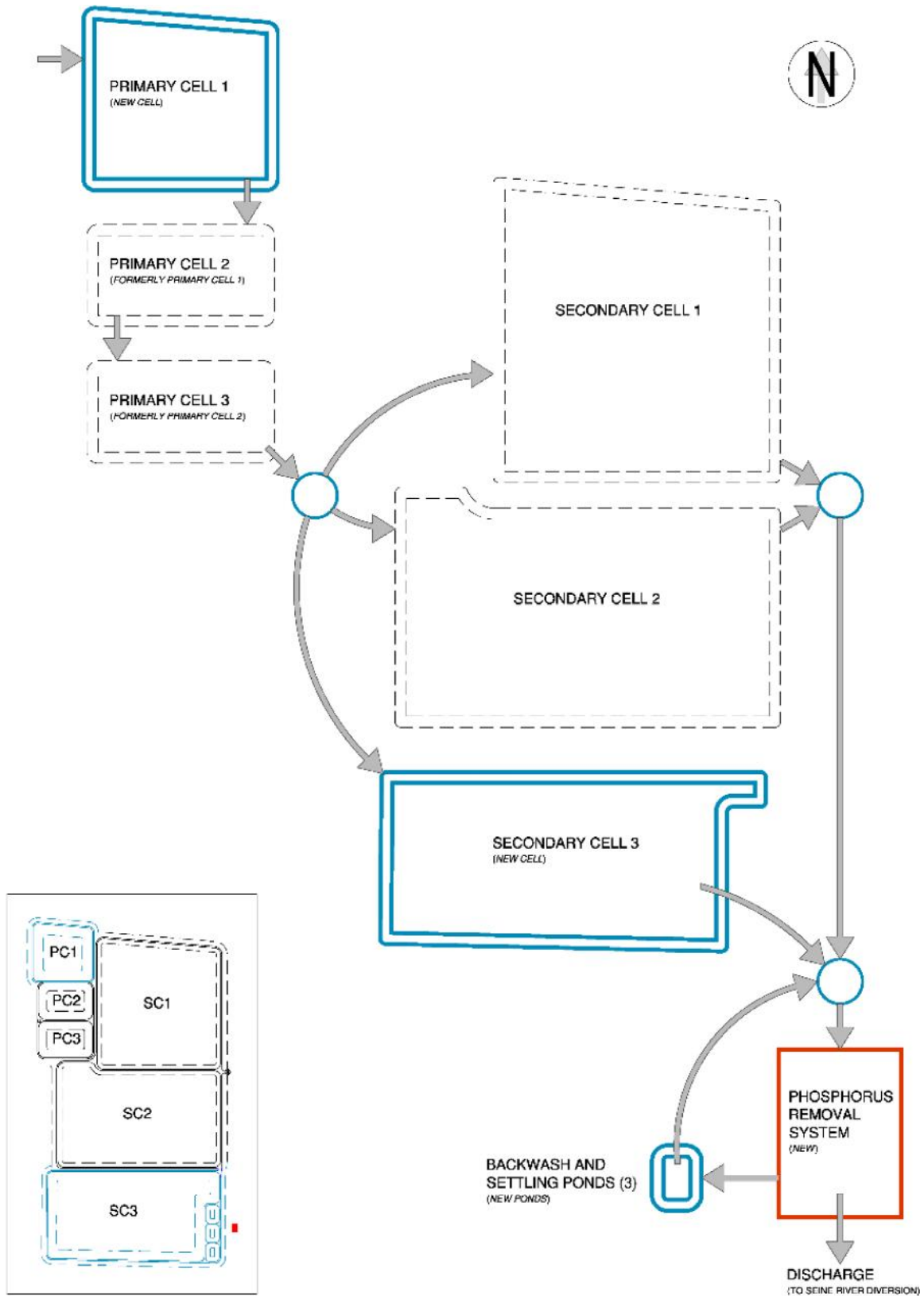

FIGURE 5.1: PROCESS FLOW DIAGRAM

6 ENVIRONMENTAL IMPACTS

6.1 ODOUR CONSIDERATIONS

It is expected that the expanded facility will operate without causing any significant odour problems. The primary cells are capable of providing treatment beyond the design population and the aeration system was originally installed because of the voiced concerns of area residence with respect to odour. The only time of the year that some minor odours may be present is during the spring while the ice thaws.

The closest residence to the lagoon is located approximately 450 metres away (to the west), which meets the Manitoba Conservation minimum setback distance of 300 metres.

6.2 LAND IMPACT

The existing lagoon was constructed in the year 2000 and the surrounding land has continued in its agricultural use without issue. The existing lagoon clay liner was constructed to current specifications and there has been no indication that the liner has been compromised in any way.

The R.M. had a rental agreement with a local farmer for the use of the land that will now be developed. Therefore, the only pre-excavation work required is topsoil stripping and stockpiling.

Section 2.3 Description of Existing Land Use should be consulted for additional information.

6.3 SURFACE WATER

From the discharge point into the Seine River Diversion, the treated effluent will flow 18.5 km to the Red River. Perimeter ditching will be maintained and extended to provide positive drainage for surface water around the lagoon, if required. Any local field drains that are interrupted by construction will be acceptably re-established or rerouted if no other alternative exists.

Because the discharge from the lagoon facility is by piped flow, no other ditches or watercourses are impacted by the lagoon effluent.

The Community of Lorette and the proposed lagoon facility are in the Seine River Diversion Watershed (No. 8). Figure 3.1 illustrates this beginning of the discharge route in the specified watershed.

The water licensing branch of Manitoba Water Stewardship was consulted to provide a list of water users along the drainage route. There are no licensed water users within the vicinity (~1.0 km upstream and ~10 km downstream) of the discharge point into the Seine River Diversion (Appendix E).

6.3.1 FUEL STORAGE ON SITE

The proposed facility does not require the onsite storage of gasoline or diesel fuel. During construction and upgrading, the contractor will be required to ensure that all equipment is properly maintained to prevent leaks and spills of fuel and motor fluids. Refuelling of equipment will not be within 100 metres of a water body, stream or wetland.

6.4 GROUNDWATER

There is a preliminary groundwater report prepared by the Planning Branch of the Water Resources Division for the RM of Taché. Based on the well logs and the synopsis, nearly the whole district is underlain by a carbonate rock (limestone and dolostone) aquifer that, in turn, is underlain by a sandstone aquifer. The well logs indicate a notable yield of 1.26 L/s to 3.2 L/s with the quality of water ranging from fair to excellent. The water is shown to be used for both livestock and domestic consumption. A review of the Groundwater Pollution Hazard Map shows that the property is located outside a groundwater pollution hazard area.

Based on the drainage map of the area, the local groundwater flow at the site is south towards the Seine River Diversion.

The design of the new lagoon complies with Manitoba Conservation guidelines and will therefore sufficiently contain the influent wastewater. There have been no indicators in the 15+ years of operation that the existing lagoon liners have been compromised. The treated effluent intended for discharge will comply with the parameters listed in the new Environment Act Licence.

6.5 SPECIES IMPACT

A file search with the Biodiversity Conservation Wildlife and Ecosystem Protection Branch of Manitoba Conservation resulted in no occurrences in the specified area of River Lot 8 in the Parish of Lorette. Correspondence is included in Appendix E.

6.6 FISHERIES

According to the 2013 Milani Report, the receiving watercourse of the treated effluent (filtrate) from the Lorette lagoon system is the Seine River Diversion which is considered type B habitat (simple habitat, indicators present), until reaching the type A habitat (complex habitat, indicators present) of the Red River.

In order to protect any potential fish in the critical springtime spawning season, when effluent un-ionized ammonia tends to be high, the lagoon has been designed to the 227-day storage period. The lagoon will discharge after June 15th and will allow for significant conversion of toxic un-ionized ammonia into relatively benign nitrates.

6.6.1 FISHERIES ACT INFORMATION

The *Fisheries Act* controls and regulates the deposit of deleterious substances into water frequented by fish. According to subsection 36(3) of the *Fisheries Act*,

“no person shall deposit or permit the deposit of a deleterious substance of any type in water frequented by fish or in any place under any conditions where the deleterious substance or any other deleterious substance that results from the deposit of the deleterious substance may enter any such water.”

6.7 FORESTRY

There is no forestry activity in the area. No treed areas should be affected by the construction associated with the development.

6.8 HERITAGE RESOURCES

In a memorandum dated April 14, 2015 from the Historic Resources Branch (Appendix E), it was stated that there are no previously recorded heritage sites located in the development, and therefore, the Historic Resources Branch has no concerns with the project.

6.9 SOCIO-ECONOMIC IMPACTS

The lagoon construction will result in a short-term boost to the construction industry in the area.

The construction equipment will be operated within the noise by-law restrictions of the R.M. of Taché.

6.10 PUBLIC INVOLVEMENT

Comments from concerned members of the public will be solicited as part of Manitoba Conservation and Water Stewardship review prior to issuing a licence.

7 MANAGEMENT PRACTICE

The expanded wastewater treatment facility is specifically designed to provide wastewater treatment and storage capacity for the existing infrastructure and proposed developments up to a population of $\pm 7,500$. The storage component of the system is the limiting constraint, as the treatment potential is for a population of 9,000. The expanded Lorette lagoon is designed to treat wastewater up to an average loading of 693 kg-BOD₅/d and store the treated effluent for 227 days. The facility will normally have a seasonal continuous discharge between the allowable period from June 15th to October 31st. After the new development, the lagoon will consist of three primary and three secondary cells.

The proposed management and operation of the facility is discussed in the following sections.

7.1 OPERATION

Operation of the expanded wastewater treatment lagoon must comply with the specifications, limits, terms and conditions of the new Environment Act Licence, as is the case with the existing Licence. The R.M. of Taché must also be in compliance with WSER and the associated reporting outlined in the Regulation.

7.1.1 COMMISSIONING

After the construction involved in expanding the lagoon is completed, all of the new or modified systems will be commissioned. While the old blowers are being replaced, a temporary portable blower will be installed to provide adequate levels of aeration to the primary treatment cells. When the new blowers are brought online, the dissolved oxygen levels in each of the primary cells will be tested to confirm 2.0 mg/L of dissolved oxygen in the top 2.0 metres of the liquid in the aeration cells.

Commissioning of the phosphorus removal system will occur during the initial discharge of the secondary cells. It is reasonable to expect that the discharges during the two months of operation will be susceptible to exceedances of the 1.0 mg/L phosphorus limit as the process takes place to link the chemical dosing to the Community of Lorette's wastewater. Bench scale testing and/or piloting of the Community's wastewater through a similar system is proposed to expedite this process. Chemical dosing will be tied to a flowmeter installed to monitor the discharge flowrate. The flowrate will be regulated by an actuated valve to control the flow through the cloth disk filter.

7.1.2 DISCHARGE

The expanded lagoon facility will be capable of storing the Community of Lorette's wastewater for 227 days at the design loading. In effect, until the design loads are reached, the lagoon will provide storage in excess of 227 days, if the need should arise for any reason.

The planned continuous seasonal discharge will be from June 15 through to October 31 or periods within. A minimum of three weeks prior to the June 15th, valves will be manipulated to isolate one or two of the secondary cells for a period of two weeks prior to testing. This schedule allows for one week to obtain the laboratory results. The third non-isolated secondary cell will continue to receive the primary treated effluent. Testing shall be conducted according to the current *Environment Act Licence* and the *Wastewater Systems Effluent Regulation*. All testing, with the exception of total phosphorus, will occur in the secondary cells prior to discharge through the phosphorus removal system.

After successful results, the isolated cell(s) will be discharged through the phosphorus removal system. Testing for total phosphorus will occur in the filtrate upon system start-up and every two weeks after during normal operation. The filtrate is immediately discharged to the Seine River Diversion.

The third secondary cell will be isolated for a period of two weeks and undergo the same testing, prior to its discharge.

With the front end aeration and the back end phosphorus removal, there is confidence that the system will be able to be discharged continuously (after the initial testing to begin the discharge), while meeting the EAL and WSER reporting requirements.

With discharge underway, it is proposed to reopen the valves that isolated the cells from the primary cells, thus achieving a seasonal continuous discharge. When at the maximum population of 7,500, Secondary Cell 1, 2 and 3 are capable of providing hydraulic retention times (HRT) of 16.4, 15.5 and 29.1 days, respectively, during the seasonal continuous discharge. These times are in addition to the HRT provided by the three primary cells operating in series. Confirmatory testing would be performed in the discharging secondary cells two weeks (14 days) after the discharging cells are removed from isolation to confirm this proposed functioning.

The discharge of the secondary cells will be stopped at or before the November 1 deadline.

7.1.3 BACKWASH AND SLUDGE

While the cells are being discharged through the phosphorus removal system, filter backwash and settled solids (approximated at 1-3% of the flow) will regularly be removed to the backwash ponds for the purpose of settling. At maximum flows, each backwash pond provides an HRT of 9.5 days at a backwash volume of 2% of the design flow. The south and central or the north and central two ponds will function together, allowing the unused pond (north or south) to be isolated for sludge removal on an alternating as required basis. The north or south pond will always be the initial backwash receiving pond with an overflow to the middle pond. Decanted overflow from the central pond will be directed into the front end of the phosphorus removal system.

Right before the discharge period ends, the remaining liquid in the central pond will be lowered to a depth of 0.3 metres. The liquid in the receiving backwash pond will be pumped down slightly to mitigate the opportunity for ice to lift the piping in the pond. Settling will occur through the freeze-thaw cycle in the pond over the winter-spring. Upon system start-up, the liquid in the settled pond will be pumped off to the top of the solids. Evaporation will dry out the solids in the cell over the course of the summer period, allowing for hauling to a landfill in the fall or prior to June 15th in the following year, when the cell will be again brought into rotation.

7.1.4 MAINTENANCE, RECORD KEEPING AND INSPECTION

The R.M. of Taché already has a routine maintenance, record keeping and inspection schedule in place. There will be some supplemental maintenance activities with the expansion of the lagoon. Generally, the maintenance list will include but is not limited to:

- Lift station – regular operational checks along with routine pump maintenance and servicing
- Gate valves – exercised on an annual basis
- Aeration blowers – weekly operational checks along with routine maintenance and servicing
- Cleaning of the aeration building intakes as required
- Cloth disk filters – weekly monitoring (with replacement expected every two years)
- Phosphorus removal system – shutdown before November 1, including dewatering of all water in the system and winterizing/storage of components
- Maintaining the supply of spare consumable parts, accessories and equipment (filters, diffusers etc.)

The record keeping and inspection list will include but is not limited to:

1. Daily Records – Water consumption and lift station pumping records should be collected and retained for future estimation of flows to the wastewater treatment lagoon.

2. Weekly Records - The weekly summer inspection would consist of recording the following: the water level, aeration bubbles, presence of odours and their source, and presence of floating objects (removal), levels in chemical supply tankage. The summer maintenance should also include grass cutting on the dykes, if necessary, elimination of emergent vegetation, extermination of burrowing animals, repair of the dykes and rip rap if damaged by wind erosion and wave action, repair of the fence and gate. Recording blower hour readings and other output readings.
3. Periodic Winter Inspection is confined to inspecting for frozen piping, checking if the water level in the cells is as it should be.
4. Discharge Records - The records should contain all treated effluent quality analyses, dates of discharge, discharge procedure followed, water levels and other pertinent data.

8 SCHEDULE AND FUNDING

It is anticipated that the Environment Act Licence process will be finalized by the winter of 2015/16 and tendering of the project will begin in early 2016 (Figure 8.1). Expansion construction is proposed for spring 2016, concluding in the fall. Dyke reconstruction for the eroded areas may take place over 2017-2018.

Project funding will be from Federal and Provincial governments, designated municipal reserves and developer contributions.

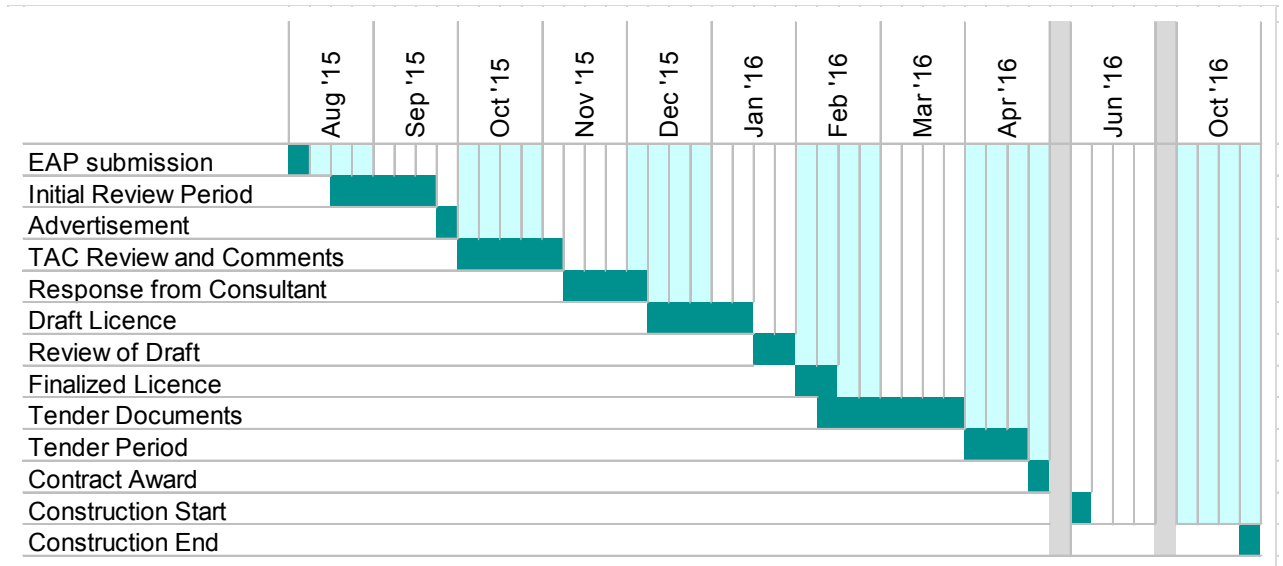

FIGURE 8.1: SCHEDULE – EAP SUBMISSION TO END OF CONSTRUCTION

9 REFERENCES

Statistics Canada. 2012. Lorette, Manitoba (Code 1373) and Manitoba (Code 46) (table). Census Profile. 2011 Census. Statistics Canada Catalogue no. 98-316-XWE. Ottawa. Released October 24, 2012. <http://www12.statcan.gc.ca/census-recensement/2011/dp-pd/prof/index.cfm?Lang=E>. Accessed: March 24, 2015

Chambers P.A., M. Guy, E.S. Roberts, M.N. Charlton, R. Kent, C. Gagnon, G. Grove, and N. Foster. 2001. *Nutrients and their impact on the Canadian environment*. Agriculture and Agri-Food Canada, Environment Canada, Fisheries and Oceans Canada, Health Canada and Natural Resources Canada. 241 p.

Government of Canada, 2015. *Wastewater Systems Effluent Regulations*. Minister of Justice. SOR/2012-139. 80 p.

Milani, D.W. 2013. *Fish community and fish habitat inventory of streams and constructed drains throughout agricultural areas of Manitoba (2002-2006)*. Can. Data Rep. Fish. Aquat. Sci. 1247: xvi + 6,153 p.

Government of Canada, 2015. *Fisheries Act*. Minister of Justice. R.S.C., 1985, c. F-14. 61 p.

Appendix A

STATUS OF TITLE

DATE: 2015/02/27
TIME: 12:01**MANITOBA**

TITLE NO: 1712839/1

STATUS OF TITLE

PAGE: 1

STATUS OF TITLE.....	ACCEPTED	PRODUCED FOR..	RM OF TACHE
ORIGINATING OFFICE...	WINNIPEG	ADDRESS.....	
REGISTERING OFFICE...	WINNIPEG		
REGISTRATION DATE....	2000/03/14		
COMPLETION DATE.....	2000/03/23		
		CLIENT FILE...	NA
		PRODUCED BY...	M.TRONINA

LEGAL DESCRIPTION:

THE RURAL MUNICIPALITY OF TACHE

IS REGISTERED OWNER SUBJECT TO SUCH ENTRIES RECORDED HEREON IN THE FOLLOWING DESCRIBED LAND:

PARCEL 1: ALL THAT PORTION OF THE ELY 396 FEET PERP OF RL 8 PARISH OF LORETTE WHICH LIES TO THE SOUTH OF THE SOUTHERN LIMIT OF RIGHT-OF-WAY PLAN 32221 WLTO EXC ALL THAT PORTION WHICH LIES TO THE SOUTH OF THE NORTHERN LIMIT OF ROAD AND WATER CONTROL WORKS PLAN 7768 WLTO

PARCEL 2: ALL THAT PORTION OF RL 8 PARISH OF LORETTE WHICH LIES TO THE SOUTH OF THE SOUTHERN LIMIT OF RIGHT-OF-WAY PLAN 32221 WLTO EXC THE ELY 396 FEET PERP

ACTIVE TITLE CHARGE(S):

C65591/1	ACCEPTED DESCRIPTION: FROM/BY: TO: CONSIDERATION:	EASEMENT FOR PIPELINE KATHERINE BURAK TRANSCANADA PIPELINES LTD.	REG'D: 1957/04/04 NOTES: TITLE ISSUED; PCL 2
C66824/1	ACCEPTED DESCRIPTION: FROM/BY: TO: CONSIDERATION:	EASEMENT GRANT OF EASEMENT PT FOR PIPE LINE PL 6485 KATHERINE BURAK, ETAL (EXECUTORS) TRANS CANADA PIPE LINES LTD.	REG'D: 1957/04/16 NOTES: TITLE ISSUED; PCL 1
C66825/1	ACCEPTED DESCRIPTION: FROM/BY: TO: CONSIDERATION:	EASEMENT GRANT OF EASEMENT PT FOR PIPE LINE PL 6485 KATHERINE BURAK, ETAL (EXECUTORS) TRANS CANADA PIPE LINES LTD.	REG'D: 1957/04/16 NOTES: PLAN 6485 - TITLE ISSUED
1561981/1	ACCEPTED DESCRIPTION: FROM/BY: TO: CONSIDERATION:	EASEMENT FOR PIPELINE, INCLUDES RIGHTS OF INGRESS AND EGRESS WALTER BURAK TRANSCANADA PIPELINES LIMITED	REG'D: 1992/07/08 NOTES: TITLE ISSUED; PCL 1

CERTIFIED TRUE EXTRACT PRODUCED FROM THE LAND TITLES DATA STORAGE SYSTEM ON 2015/02/27 OF TITLE NUMBER 1712839/1

***** STATUS OF TITLE 1712839/1 CONTINUED ON NEXT PAGE *****

DATE: 2015/02/27
TIME: 12:01

STATUS OF TITLE

PAGE: 2

STATUS OF TITLE.....	ACCEPTED	PRODUCED FOR..	RM OF TACHE
ORIGINATING OFFICE...	WINNIPEG	ADDRESS.....	
REGISTERING OFFICE...	WINNIPEG		
REGISTRATION DATE....	2000/03/14		
COMPLETION DATE.....	2000/03/23		
		CLIENT FILE...	NA
		PRODUCED BY...	M.TRONINA

ACTIVE TITLE CHARGE(S):

1562153/1	ACCEPTED	EASEMENT	REG'D: 1992/07/08
DESCRIPTION:		FOR PIPELINE, INCLUDES RIGHTS OF INGRESS AND EGRESS	
FROM/BY:		WALTER BURAK AND JEANNETTE BURAK	
TO:		TRANSCANADA PIPELINES LIMITED	
CONSIDERATION:		NOTES: TITLE ISSUED; PCL 2	
1571776/1	ACCEPTED	EASEMENT	REG'D: 1992/08/05
DESCRIPTION:		FOR PIPELINE, INCLUDES RIGHTS OF INGRESS AND EGRESS	
FROM/BY:		KATHERINE BURAK	
TO:		TRANSCANADA PIPELINES LIMITED	
CONSIDERATION:	\$1,000.00	NOTES: TITLE ISSUED; PCL 2	
2121861/1	ACCEPTED	EASEMENT	REG'D: 1997/03/13
DESCRIPTION:		FOR PIPELINE - RIGHT OF INGRESS AND EGRESS	
FROM/BY:		WALTER BURAK AND JEANNETTE BURAK	
TO:		TRANSCANADA PIPELINES LIMITED	
CONSIDERATION:		NOTES: TITLE ISSUED; PCL 1	
2121867/1	ACCEPTED	EASEMENT	REG'D: 1997/03/13
DESCRIPTION:		FOR PIPELINE - RIGHT OF INGRESS AND EGRESS	
FROM/BY:		WALTER BURAK AND JEANNETTE BURAK	
TO:		TRANSCANADA PIPELINES LIMITED	
CONSIDERATION:		NOTES: TITLE ISSUED; PCL 2	
2470914/1	ACCEPTED	CAVEAT	REG'D: 2000/03/14
DESCRIPTION:		LEASE AGREEMENT	
FROM/BY:		WALTER BURAK AND JEANNETTE BURAK	
TO:		GERALD SIMARD AS AGENT	
CONSIDERATION:		NOTES:	

ADDRESS(ES) FOR SERVICE:

EFFECT	NAME AND ADDRESS	POSTAL CODE
ACTIVE	R.M. OF TACHE BOX 100 450 DAWSON ROAD LORETTE MB	ROA OYO

CERTIFIED TRUE EXTRACT PRODUCED FROM THE LAND TITLES DATA
STORAGE SYSTEM ON 2015/02/27 OF TITLE NUMBER 1712839/1

DATE: 2015/02/27
TIME: 12:01

MANITOBA

TITLE NO: 1712839/1

STATUS OF TITLE

PAGE: 3

STATUS OF TITLE..... ACCEPTED
ORIGINATING OFFICE... WINNIPEG
REGISTERING OFFICE... WINNIPEG
REGISTRATION DATE.... 2000/03/14
COMPLETION DATE..... 2000/03/23

PRODUCED FOR.. RM OF TACHE
ADDRESS.....

CLIENT FILE... NA
PRODUCED BY... M.TRONINA

ORIGINATING INSTRUMENT(S):

REGISTRATION NUMBER	TYPE	REG. DATE	CONSIDERATION	SWORN VALUE
2470913/1	T	2000/03/14	\$149,490.00	\$149,490.00

PRESENTED BY: THOMPSON DORFMAN SWEATMAN
FROM: WALTER BURAK AND JEANNETTE BURAK
TO: THE RURAL MUNICIPALITY OF TACHE

FROM TITLE NUMBER(S):

1495843/1 PART 1495310/1 ALL

LAND INDEX:

LOT	TYPE	PARISH
8	RIVER LOT	LORETTE

NOTE: E396'P S OF PL32221EX PT S OFNLIPL7768;PT S OF PL32221

ACCEPTED THIS 14TH DAY OF MARCH, 2000
BY C.DRYDEN FOR THE DISTRICT REGISTRAR OF
THE LAND TITLES DISTRICT OF WINNIPEG.

CERTIFIED TRUE EXTRACT PRODUCED FROM THE LAND TITLES DATA
STORAGE SYSTEM ON 2015/02/27 OF TITLE NUMBER 1712839/1.

***** END OF STATUS OF TITLE 1712839/1 *****

Appendix B

EXISTING ENVIRONMENT ACT LICENCE

Licence No.: 2439

Licence Issued: January 14, 2000

**IN ACCORDANCE WITH THE MANITOBA ENVIRONMENT ACT (C.C.S.M. c. E125)
THIS LICENCE IS ISSUED PURSUANT TO SECTION 11(1) TO:**

RURAL MUNICIPALITY OF TACHE; "the Licencee"

for the construction, operation and maintenance of the Development being a wastewater collection system, an aerated wastewater treatment lagoon located on River Lot 8, Parish of Lorette in the Rural Municipality of Tache and a forcemain connection between the Local Urban District (L.U.D.) of Lorette and the aerated lagoon and with discharge of treated effluent to a drainage ditch that flows into the Seine River Diversion which empties into the Red River, in accordance with the Proposal filed under The Environment Act on October 28, 1999 and previously submitted forcemain information provided on October 6, 1999 and subsequent information provided on November 29, 1999 and January 5, 2000, and subject to the following specifications, limits, terms and conditions:

DEFINITIONS

In this Licence,

"accredited laboratory" means a laboratory accredited by the Standard Council of Canada (SCC), another accrediting agency recognized by Manitoba Conservation to be equivalent to the SCC, or at a laboratory which can demonstrate to Manitoba Conservation that it has the quality assurance/quality control (QA/QC) procedures in place equivalent to accreditation based on the Canadian Standard Can/CSA-Z753, extension of the international standard ISO 9000, Guide 25;

"approved" means approved by the Director in writing;

"appurtenances" means machinery, appliances, or auxiliary structures attached to a main structure to enable it to function, but not considered an integral part of it;

"aerated" means the bringing about of intimate contact between air and a liquid by bubbling air through the liquid;

"as constructed drawings" means engineering drawings complete with all dimensions which indicate all features of the Development as it has actually been built;

"ASTM" means the American Society for Testing and Materials;

"Director" means an employee so designated pursuant to The Environment Act;

"effluent" means treated wastewater flowing or pumped out of the wastewater treatment lagoon;

"fecal coliform" means aerobic and facultative, Gram-negative, nonspore-forming, rod-shaped bacteria capable of growth at 44.5° C, and associated with fecal matter of warm-blooded animals;

"five-day biochemical oxygen demand" means that part of the oxygen demand usually associated with biochemical oxidation of organic matter within five days at a temperature of 20° C;

"flooding" means the flowing of water onto lands, other than waterways, due to the overtopping of a waterway or waterways;

"high water mark" means the line on the interior surface of the primary and secondary cells which is normally reached when the cell is at the maximum allowable liquid level or the line of the exterior of the perimeter dykes which is reached during local flooding;

"hydraulic conductivity" means the quantity of water that will flow through a unit cross-sectional area of a porous material per unit of time under a hydraulic gradient of 1.0;

"in-situ" means on the site;

"low water mark" means the line on the interior surface of the primary and secondary cells which is normally reached when the cell is discharged;

"MPN Index" means the most probable number of coliform organisms in a given volume of wastewater which, in accordance with statistical theory, would yield the observed test result with the greatest frequency;

"primary cell" means the first in a series of cells of the wastewater treatment lagoon system and which is the cell that receives the untreated wastewater;

"riprap" means small, broken stones or boulders placed compactly or irregularly on dykes or similar embankments for protection of earth surfaces against wave action or current;

"secondary cell" means a cell of the wastewater treatment lagoon system which is the cell that receives partially treated wastewater from the primary cell;

"septage" means the sludge produced in individual on-site wastewater disposal systems such as septic tanks;

"sewage" means household and commercial wastewater that contains human waste;

"sludge" means the accumulated solids separated from liquids, such as water or wastewater, during processing;

"Standard Methods for the Examination of Water and Wastewater" means the most recent edition of Standard Methods for the Examination of Water and Wastewater published jointly by the American Public Health Association, the American Waterworks Association and the Water Environment Association;

"total coliform" means a group of aerobic and facultative anaerobic, Gram-negative, nonspore-forming, rod-shaped bacteria, that ferment lactose with gas and acid formation within 48 hours at 35° C, and inhabit predominantly the intestines of man or animals, but are occasionally found elsewhere and include the sub-group of fecal coliform bacteria;

"wastewater" means the spent or used water of a community or industry which contains dissolved and suspended matter;

"wastewater collection system" means the sewer and pumping system used for the collection and conveyance of domestic, commercial, and industrial wastewater; and

"wastewater treatment lagoon" means the component of the development which consists of an impoundment into which wastewater is discharged for storage and treatment and natural oxidation.

GENERAL TERMS AND CONDITIONS

This Section of the Licence contains requirements intended to provide guidance to the Licencee in implementing practices to ensure that the environment is maintained in such a manner as to sustain a high quality of life, including social and economic development, recreation and leisure for present and future Manitobans.

1. The Licencee shall direct all wastewater generated within the L.U.D. of Lorette toward the wastewater treatment lagoon or other approved sewage treatment facilities.
2. In addition to any of the limits, terms and conditions specified in this Licence, the Licencee shall, upon the request of the Director:
 - a. sample, monitor, analyze and/or investigate specific areas of concern regarding any segment, component or aspect of pollutant storage, containment, treatment, handling, disposal or emission systems, for such pollutants or ambient quality, aquatic toxicity, leachate characteristics and discharge or emission rates, for such duration and at such frequencies as may be specified;
 - b. determine the environmental impact associated with the release of any pollutant(s) from the Development; or
 - c. provide the Director, within such time as may be specified, with such reports, drawings, specifications, analytical data, descriptions of sampling and analytical procedures being used, bioassay data, flow rate measurements and such other information as may from time to time be requested.
3. The Licencee shall operate and maintain the wastewater treatment lagoon and wastewater collection system in such a manner that the release of offensive odours is minimized.
4. The Licencee shall, in case of physical or mechanical breakdown of the wastewater collection and/or treatment system:
 - a. notify the Director immediately;
 - b. identify the repairs required to the wastewater collection and/or treatment system;
 - c. undertake all repairs to minimize unauthorized discharges of wastewater; and
 - d. complete the repairs in accordance with any written instructions of the Director.
5. The Licencee shall, unless otherwise specified in this Licence:
 - a. carry out all preservations and analyses on liquid samples in accordance with the methods prescribed in "Standard Methods for the Examination of Water and Wastewater" or in accordance with an equivalent analytical methodology approved by the Director;
 - b. ensure that all analytical determinations are undertaken by an accredited laboratory;

and

- c. report the results to the Director, in writing or in a format acceptable to the Director, within 60 days of the samples being taken.
6. The Licencee shall ensure that, during construction and operation of the Development, spills of fuels or other contaminants are reported to an Environment Officer in accordance with the requirements of *Manitoba Regulation 439/87* respecting *Environmental Accident Reporting*.
 7. The Licencee shall ensure that non-reusable demolition and construction debris from the Development is disposed of at a waste disposal ground operating under the authority of a permit issued under *Manitoba Regulation 150/91* respecting *Waste Disposal Grounds*.
 8. The Licencee shall notify the Director of, and receive approval from the Director for, any alteration in the Development as Licenced, prior to proceeding with such alteration.

SPECIFICATIONS, LIMITS, TERMS AND CONDITIONS

9. The Licencee shall, prior to the construction of the dykes for the wastewater treatment lagoon, remove the organic topsoil from the area where the dykes will be constructed.
10. The Licencee shall construct and maintain the wastewater treatment lagoon, with a continuous liner under all interior surfaces of the cells in accordance with the following specifications:
 - a. the liner shall be made of clay;
 - b. the liner shall be at least one metre in thickness;
 - c. the liner shall have a hydraulic conductivity of 1×10^{-7} centimetres per second or less at all locations; and
 - d. the liner shall be constructed to an elevation of 4.6 metres above the floor elevation of the primary cells and an elevation of 2.5 metres above the floor elevation of the secondary cells.
11. The Licencee shall operate and maintain the wastewater treatment lagoon in such a manner that:
 - a. a minimum of 2 milligrams of dissolved oxygen per litre is detectable at all times in the top 2.0 metres of the liquid in the aerated primary cells;
 - b. the organic loading on the wastewater treatment lagoon, in terms of the five-day biochemical oxygen demand, is not in excess of 280 kilograms per day; and
 - c. the depth of liquid in the aerated primary cells does not exceed 3.6 metres and the depth of liquid in the secondary cells does not exceed 1.5 metres.
12. The Licencee shall ensure that if, in the opinion of the Director, significant erosion of the interior surfaces of the dykes occurs, rip rap shall be placed on the interior dyke surfaces from 0.6 metres above the high water mark to at least 0.6 metres below the low water mark to protect the dykes from wave action.
13. The Licencee shall install and maintain a fence around the wastewater treatment lagoon to control access.
14. The Licencee shall construct and maintain an all-weather access road to the wastewater treatment

lagoon.

15. The Licencee shall ensure that septage is not discharged to the Development.
16. The Licencee shall provide and maintain a grass cover on the dykes of the wastewater treatment lagoon and shall regulate the growth of the vegetation so that the height of the vegetation does not exceed 0.3 metres on all dykes.
17. The Licencee shall annually remove by mechanical methods all reeds, rushes and trees located above the low water mark in every cell of the wastewater treatment lagoon.
18. The Licencee shall implement an ongoing program to ensure that burrowing animals are removed from the site of the wastewater treatment lagoon.
19. The Licencee shall not discharge effluent from the wastewater treatment lagoon:
 - a. where the organic content of the effluent, as indicated by the five-day biochemical oxygen demand (BOD₅), is in excess of 30 milligrams per litre;
 - b. where the fecal coliform content of the effluent, as indicated by the MPN index, is in excess of 200 per 100 millilitres of sample; or
 - c. where the total coliform content of the effluent, as indicated by the MPN index, is in excess of 1500 per 100 millilitres of sample; or
 - d. between the 1st day of November of any year and the 15th day of June of the following year.
20. The Licencee shall construct waterway crossings by augering, tunneling or boring. Open cut waterway crossings shall not be made unless prior consultation with Manitoba Natural Resources staff and Department of Fisheries and Oceans staff has occurred and the prior written approval of the Director has been obtained. This condition applies on continuously flowing watercourses at all times, and on intermittent streams and artificial drainage channels only when flow is occurring.
21. The Licencee shall revegetate soil exposed during the construction of the Development with native or introduced grasses or legumes. Native species shall be used to revegetate areas where native species existed prior to construction. Revegetation is not required for pipelines installed by chain trenching or ploughing on previously disturbed ground including road allowances or on the floors of the wastewater treatment lagoon.
22. The Licencee shall ensure that local drainage patterns are not altered by the construction of the Development, including inflows and outflows from small wetlands adjacent to the route of pipelines.
23. The Licencee shall, where open cut stream crossing techniques are used on intermittent waterways and artificial drainage channels, minimize disturbance to riparian areas and restore the bottom and banks of the waterways to their original elevations and shapes.
24. The Licencee shall notify the assigned Environment Officer not less than two weeks prior to beginning construction of the Development. The notification shall include the intended starting date of construction and the name of the contractor responsible for the construction.

25. The Licencee shall separate and replace topsoil from backhoe and trenching operations in accordance with the methodology described in Figures 1, 2 and 3 attached to this Licence. This requirement is not applicable where the topsoil has been previously disturbed due to the construction of roads or drains.
26. Notwithstanding Clause 20 of this Licence, the Licencee shall not construct open cut crossings of streams associated with the Development between April 1 and June 15 of any year. Open cut crossings shall comply with the provisions of the Canadian Association of Petroleum Producers publication "Watercourse Crossing Guidelines for Pipeline Systems" (1993).
27. The Licencee shall ensure that fuel storage and equipment servicing areas established for the construction and operation of the Development are located a minimum distance of 100 metres from any waterbody, and shall comply with the requirements of *Manitoba Regulation 97/88R* respecting *Storage and Handling of Gasoline and Associated Products*.

MONITORING AND REPORTING

28. The Licencee shall:
 - a. weekly assess the operation of the aeration system blowers;
 - b. annually inspect the aeration system and make any necessary repairs;
 - c. maintain a record of aeration system inspection dates, observations, maintenance and repairs completed; and
 - d. make records of these activities available to the designated Environment Officer on request.
29. The Licencee shall maintain records of the wastewater collection system and wastewater treatment lagoon operations and/or maintenance requirements including, but not limited to, the following:
 - a. lift station pumps daily elapsed time and service activities;
 - b. aeration system pumps daily elapsed time;
 - c. weekly summer and winter liquid levels in all cells and presence of odours and their source;
 - d. weekly winter inspections for frozen piping ;
 - e. liquid levels, duration of discharge, and procedures followed at the start of and during discharge(s); and
 - f. make these records available to the designated Environment Officer on request.
30. The Licencee shall prior to each effluent discharge, obtain grab samples of the treated wastewater and have them analyzed for:
 - a. organic content as indicated by the five day biochemical oxygen demand and expressed as milligrams per litre;
 - b. fecal coliform content as indicated by the MPN index and expressed as MPN per 100 millilitres of sample;
 - c. total coliform content as indicated by the MPN index and expressed as MPN per 100 millilitres of sample; and
 - d. submit the results of the analyses to the Director prior to each effluent discharge.

31. The Licencee shall:
- a. during each year maintain records of:
 - i. wastewater sample dates;
 - ii. original copies of laboratory analytical results of the sampled wastewater; and
 - iii. effluent discharge dates;
 - b. make the records being maintained pursuant to Sub-Clause 31 (a) of this Licence available to an Environment Officer upon request; and
 - c. keep the maintained records of any one calendar year available for inspection for a period of three years following the respective calendar year in which they were recorded.
32. The Licencee shall actively participate in any current or future watershed-based management study, plan and/or nutrient reduction program, approved by the Director, for the Seine River Diversion and associated waterways and watersheds.
33. The Licencee shall arrange with the designated Environment Officer a mutually acceptable time and date for any required soil sampling between the 15th day of May and the 15th day of October of any year.
34. The Licencee shall take and test undisturbed soil samples, in accordance with Schedule "A" attached to this Licence, from the liner of the wastewater treatment lagoon; the number and location of samples and test methods to be specified by the designated Environment Officer up to a maximum of 30 samples.
35. The Licencee shall, not less than 2 weeks before the wastewater treatment system and wastewater treatment lagoon are placed in operation, submit to the Director the results of the tests carried out pursuant to Clause 34 of this Licence.
36. The Licencee shall:
- a. prepare "as constructed drawings" for the Development and shall label the drawings "As Constructed"; and
 - b. provide to the Director, on or before 30th day of March, 2001, two sets of "as constructed drawings" of the wastewater treatment lagoon.

DECOMMISSIONING OF OLD WASTEWATER TREATMENT LAGOON

37. The Licencee shall, after placing the Development into operation, prevent any additional wastewater or septage from being discharged into the old wastewater treatment lagoon located on River Lots 49 and 50 in the Parish of Lorette in the Rural Municipality of Tache, Manitoba.
38. The Licencee shall:
- a. remove the wastewater from the old wastewater treatment lagoon and transport it to the new wastewater treatment lagoon located on River Lot 8 in the Parish of Lorette

- in the Rural Municipality of Tache, Manitoba or discharge treated effluent in accordance with Environment Act Licence No. 619;
- b. dewater the sludge in the old wastewater treatment lagoon;
 - c. remove all of the sludge from the old wastewater treatment lagoon;
 - d. dispose of the sludge at a waste disposal ground operated under a permit issued in accordance with Manitoba Regulation 150/91; and
 - e. level the site to the original grade.
39. The Licencee shall ensure that the use of the site of the old wastewater treatment lagoon is restricted to the growing of the following agricultural crops for a period of three years after the site has been leveled:
- a. a cereal crop;
 - b. a forage crop; or
 - c. an oil seed crop.
40. At the expiration of the three-year period, the Licencee shall ensure that the continuing use of the site shall be in accordance with the by-laws of the Rural Municipality of Tache, and other Federal and Provincial regulations as applicable.

REVIEW AND REVOCATION

- A. Environment Act Licence No. 1989RR is hereby rescinded.
- B. If, in the opinion of the Director, the Licencee has exceeded or is exceeding or has or is failing to meet the specifications, limits, terms, or conditions set out in this Licence, the Director may, temporarily or permanently, revoke this Licence.
- C. If the Licencee has not commenced construction of the Development within three years of the date of this Licence, the Licence is revoked.
- D. If, in the opinion of the Director, new evidence warrants a change in the specifications, limits, terms or conditions of this Licence, the Director may require the filing of a new proposal pursuant to Section 11 of The Environment Act.

"original signed by"

Larry Strachan, P. Eng.

Director

Environment Act

Client File No.: 4482.00

Schedule "A" to Environment Act Licence No. 2439

Soil Sampling:

1. The Licencee shall provide a drilling rig, acceptable to the designated Environment Officer, to extract soil samples from the liner which is not placed or found at the surface of the lagoon structure. This includes all wastewater treatment lagoons constructed with clay cutoffs at the

interior base of the dyke or with a clay cutoff in the centre of the dyke. The drill rig shall have the capacity to drill to the maximum depth of the clay cutoff plus an additional 2 metres. The drill rig shall be equipped with both standard and hollow stem augers. The minimum hole diameter shall be 5 inches.

2. For lagoon liners placed or found at the surface of the lagoon structure, the Licencee shall provide a machine, acceptable to the designated Environment Officer, capable of pressing a sampling tube into the liner in a straight line motion along the centre axis line of the sample tube and without sideways movement.
3. Soil samples shall be collected and shipped in accordance with ASTM Standard D 1587 (Standard Practice for Thin-Walled Tube Sampling of Soils), D 4220 (Standard Practice for Preserving and Transporting Soil Samples) and D 3550 (Standard Practice for Ring-Lines Barrel Sampling of Soils). Thin-walled tubes shall meet the stated requirements including length, inside clearance ratio and corrosion protection. An adequate venting area shall be provided through the sampling head.
4. At the time of sample collection, the designated Environment Officer shall advise the Licencee as to the soil testing method that must be used on each sample. The oedometer method may be used for a sample were the Environment Officer determines that the soil sample is taken from an undisturbed clay soil which has not been remoulded and which is homogeneous and unweathered. The triaxial test shall be used for all samples taken from disturbed and remoulded soils or from non homogenous and weathered soils.
5. The Licencee shall provide a report on the collection of soil samples to the designated Environment Officer and to the laboratory technician which includes but is not limited to: a plot plan indicating sample location, depth or elevation of sample, length of advance of the sample tube length of soil sample contained in the tube after its advancement, the soil test method specified by the Environment Officer for each soil sample and all necessary instructions from the site engineer to the laboratory technician.
6. All drill and sample holes shall be sealed with bentonite pellets after the field drilling and sampling has been completed.

Soil Testing Methods:

1. Triaxial Test Method
 - a. The soil samples shall be tested for hydraulic conductivity using ASTM D 5084 (Standard Test Method for Measurement of Hydraulic Conductivity of Saturated Porous Materials Using a Flexible Wall Permeameter).
 - b. Soil specimens shall have a minimum diameter of 70 mm (2.75 inches) and a minimum height of 70 mm (2.75 inches). The soil specimens shall be selected from a section of the soil sample which contains the most porous material based on a visual inspection. The hydraulic gradient shall not exceed 30 during sample preparation and testing. Swelling of the soil specimen should be controlled to adjust for: the amount of compaction measured during sample collection and extraction from the tube and the depth or elevation of the sample. The effective stress used during saturation or consolidation of the sample shall not exceed 40 kPa (5.7 psi) or the specific stress

level, that is expected in the field location where the sample was taken, which ever is greater.

- c. The complete laboratory report, as outlined in ASTM D 5084, shall be supplied for each soil sample collected in the field.

2. Oedometer Test Method

- a. The soil samples shall be tested for hydraulic conductivity using ASTM D 2435 (Standard Test Method for One-Dimensional Consolidation Properties of Soils).
- b. Soil specimens shall have a minimum diameter of 50 mm (2 inches) and a minimum height of 20 mm (0.8 inches). The soil specimens shall be selected from a section of the soil sample which contains the most porous material based on a visual inspection. The soil specimen shall be taken from an undisturbed soil sample. The soil specimen shall be completely saturated.
- c. The complete laboratory report, as outlined in ASTM D 2435, shall be supplied for each soil sample collected in the field.

Appendix C

GEOTECHNICAL REPORT

**GEOTECHNICAL REPORT
PROPOSED RM OF TACHE (LORETTE) WWSP EXPANSION
LORETTE, MANITOBA**

**Prepared for:
RM of Taché
Box 100, 1294 Dawson Road
Lorette, MB
R0A 0Y0**

**Project No: 151-01887-00
July, 2015**



**WSP Canada Inc.
1600 Buffalo Place
Winnipeg, MB R3T 6B8
Phone: (204) 477-6650 ~ Fax: (204) 474-2864**

www.wspgroup.com

TABLE OF CONTENTS

1.0	INTRODUCTION	1
2.0	BACKGROUND	1
3.0	TOPOGRAPHY	1
4.0	FIELD METHODOLOGY AND TESTING.....	2
5.0	SUBSURFACE INVESTIGATION	2
	5.1 SOIL PROFILE/GROUNDWATER	2
	5.2 LABORATORY TESTING	3
6.0	DESIGN CONSIDERATIONS	4
7.0	ADDITIONAL CONSIDERATIONS	7
8.0	STANDARD LIMITATIONS.....	10

APPENDICES

Appendix A – Site Plan and Slope Models

Appendix B – Testhole Logs and Well Logs

Appendix C – Laboratory Test Results

1.0 INTRODUCTION

The Rural Municipality of Taché is located to the south-east of Winnipeg, stretching from the Red River Floodway in the west to the beginning of the Canadian Shield in the east. Lorette and Landmark are the main residential and commercial hubs of the municipality with Ste.Geneviève, Dufresne, Ross and Linden as other noteworthy communities. As part of future development for the RM of Taché, a geotechnical investigation of the proposed wastewater lagoon expansion site for Lorette located at River Lot 8, Parish of Lorette was conducted.

This report deals with the expansion of the wastewater lagoon based on the soil conditions with respect to the Environmental Act passed in 1988. Manitoba Conservation's Environmental guidelines require that the dykes and the bottom of any lagoon be provided with a layer consisting of at least one metre of soil having a permeability of 1×10^{-7} cm/s or less or equivalence, i.e. the use of a plastic liner.

2.0 BACKGROUND

At present, the RM of Taché (Lorette) has an existing wastewater storage pond comprised of two primary cells and two secondary cells located at River Lot 8, Parish of Lorette.

3.0 TOPOGRAPHY

The proposed site is located on an area known as the Red River Plain Sub-Area. The Red River Plain sub-area is a clay basin, with local flood plains and river levees, which occupies the flat areas in the lower-lying part of the Lake Agassiz basin. The area consists of lacustrine clay and alluvial deposits which range from a few metres to 15m or more in thickness. Limestone bedrock below thick clay and till layers (see the attached nearest well logs of River Lot 8, Parish of Lorette) underlies much of the surficial deposits below 19.8m or more below grade.

4.0 FIELD METHODOLOGY AND TESTING

The subsoils encountered were visually classified to the full extent in the testhole and representative soil samples were recovered at regular depth intervals and some samples were submitted for moisture content tests. Pocket penetrometer tests were conducted on the cohesive soil to determine the approximate unconfined compressive strength and relative density respectively. In addition, one Shelby tube soil sample was obtained and tested for hydraulic conductivity. Any groundwater seepage and sloughing encountered in the testholes were noted.

The field investigation was undertaken on April 17, 2015. A tracked-drill rig was used to drill a total of 11 testholes between 4.6m and 12.2m depths below grade. The testhole locations are shown on the site plan in Appendix A. Detailed descriptions of the soil profiles in each testhole are shown on the attached logs, TH1 to TH11 in Appendix B. Laboratory test results for moisture contents and hydraulic conductivity are attached in Appendix C.

5.0 SUBSURFACE CONDITIONS

5.1 SOIL PROFILE/GROUNDWATER

The general soil profile reveals a topsoil layer of about 100mm to 200mm followed by a thick clay layer, which extended to the bottom of the testholes at 12.2m below grade.

With the exceptions of TH3, TH5, TH7 and TH9, high plasticity clay was observed beneath the topsoil layer down to 7.6m depth. The exception testholes (TH3, TH5, TH7 and TH9) is where a SILTY CLAY layer was encountered at 0.6m down to 3.3m depth.

No seepage and caving conditions were observed from the testholes. Detailed description of testholes, TH1 to TH11 are shown in Appendix B.

Groundwater

There is a synopsis groundwater report prepared by the planning branch of the Water Resources Division for RM of Taché. Based on the attached well logs (Appendix B) and the synopsis, nearly the whole district is underlain by a carbonate rock (limestone and dolostone) aquifer that, in turn, is underlain by a sandstone aquifer. The well logs indicate a notable yield of 1.26L/s to 3.2L/s with the quality of water ranging from fair to excellent. The water is shown to be used for both livestock and domestic consumption.

A review of the Groundwater Pollution Hazard Map - Winnipeg Area shows the property is located outside the groundwater pollution hazard area.

Based on the drainage map of the area, the local groundwater flow at the site is south towards the Seine River Diversion.

5.2 LABORATORY TESTING

In the laboratory, selected samples as shown in Appendix C were submitted for moisture contents, Atterberg limits and one sample for hydraulic conductivity. The test results are shown in Appendix C.

As classified during our field investigation, the clay layer encountered at the site is not consistent. Some areas consist of silt inclusions between 0.6m and 3.3m below grade as shown by TH3, TH5, TH7 and TH9. The silt inclusions ranged from 0.6m to 3.3m depth. Since some areas do not show any silt inclusions, the clay at a 1.5m depth (TH8) is representative of the high plasticity clay. Due to this reason, hydraulic conductivity of the in-situ clay at 1.5m depth (TH8-1.5m) was tested.

The clay material at the 1.5m depth is a CL/CH material based on the Atterberg Limit test. The estimated hydraulic conductivity of this material should range between 10^{-7} to 10^{-9} cm/s.

The actual hydraulic conductivity of the in-situ clay obtained at the 1.5m depth for TH8 was **2.64×10^{-9} cm/s**.

6.0 DESIGN CONSIDERATIONS

The proposed WWSP will be designed in accordance with the Province of Manitoba Design Objectives for Standard Sewage Lagoons (1985).

The proposed aerated primary cell and secondary cell will contain a liquid depth of 4.6m and 2.1m respectively with 1m freeboard to minimize the effects of wave action and to provide stability. The top of the dykes will be designed to be 3m wide to permit vehicles to be driven on the dyke crest.

Typically, the inside and outside side slopes of the dykes are designed to be 4H:1V if the liquid depth is 1.5m. Since the liquid depth for both secondary and primary cells is more than 1.5m depth, consideration should be given to an inside slopes of more than 4H: 1V. Thus, a slope analysis of the dykes using a 5H:1V slope was conducted.

The stability of the dykes was evaluated using a GEO-SLOPE software modelling and Modified Bishop method without any pressure lines and assumed circular failure surfaces. The soil strength parameters utilized were based on Graham (1985) successfully used "residual" strength parameters, (3-5 kPa (63-105 psf) and 8-12 degrees for failed slopes; 5 kPa (105 psf) and 15-17 degrees for first time slides) in the Winnipeg area. The residual parameters as shown in the graphs were used from the top of dykes to the bottom of cells using a rapid drawdown scenario, of which the liquid depth is lowered from the top to bottom within 7 days. This scenario will be conducted to simulate the worst case condition that might occur on these dykes. These residual parameters were followed by in-situ clay parameters of which conservative soil strength values were used in the slope analysis.

As shown in the attached graphs (Figure 2 to 5, Appendix A), the 5:1 slope was determined to have a safety factor of 2.87 after 1 year of operation and a safety of factor of 2.2 after a 7 day of rapid drawdown scenario (worst case). *Geotechnically, a safety factor over 1.5 is used as a guideline for determining the long-term stability of the dykes with respect to pre and post construction. Based on the slope analysis, the 5H:1V slope is recommended for the proposed aerated primary cell and secondary cell.*

For lagoon construction, Manitoba Conservation's Environmental guidelines require that the proposed dykes and bottom of the proposed cells be provided with a layer consisting of at least one metre of soil having a permeability of less than 1×10^{-7} cm/s.

The selected area, unfortunately, consists mainly of upper CH clay followed by SILTY CLAY inclusions, which may not meet the specified hydraulic conductivity of 1×10^{-7} cm/s. Beneath the SILTY CLAY is a high plasticity clay down to 12.2m below grade and which achieved a hydraulic conductivity test result of less than 1.0×10^{-7} cm/s, thus meeting the guideline for clay liner.

For this reason, it is recommended that the proposed pond liner (base and interior) for the proposed site should be constructed with a clay core within the proposed dykes. *Although not encountered during our investigation, seepage and caving conditions from the SILTY CLAY layer is anticipated.* If this is the case, then DEWATERING should be conducted prior to constructing the clay core. DEWATERING using perimeter trenching or wells should be incorporated into the contractor's construction costs. *Otherwise, the use of a slurry wall using bentonite mix with the wet silt is another option. The bentonite slurry mix wall will replace the trench backfilled clay and still have to be keyed into the underlying impervious high plastic clay. The slurry mix should be able to pass the Manitoba Conservation guideline for a clay liner.*

This recommendation below is on the assumption of working in dry soil conditions. This would involve excavating a trench approximately two metres wide (minimum) around the inside perimeter of the bottom of the proposed pond and keying into the underlying impervious high plastic clay to an approximate depth between 1.5m (TH3) and 3.3m (TH9) below ground surface. The average depth of the key trench is about 1.5m to 1.8m. The trench will be backfilled with impervious clay in 150mm lifts compacted by at least eight passes with a sheepsfoot roller.

Since the existing cells have a clay core as a liner, attempts should be made to connect the future clay core to the existing clay core. Otherwise, ensure that the outside slopes of existing dykes should be covered with at least 1m of CH material compacted to at least

95% Standard Proctor density during the construction of the expansion. Thus the future clay core could be connected to the 1m liner of the existing dyke.

During construction of the proposed expansion cells, the following steps should be followed.

1. The entire area for the proposed pond should be stripped of vegetation, topsoil and organic material; the depth of stripping is approximately 100mm to 200mm. The stripped materials should be stockpiled and reused later for the outer slopes and top of the dykes.
2. Layout the proposed pond to the dimensions indicated in the design drawings.
3. For the proposed bottom and interior dykes, the liner and the key should be compacted to 95% standard Proctor density at ± 2 to 3% of optimum moisture content with a sheepsfoot roller. *Any unsuitable material such as sand or high percentage silt materials should be removed and replaced with the recommended liner and compacted to 95% Standard Proctor density.* Ensure that the liner (1m clay liner) consists of at least one metre width of impervious clay compacted to at least a minimum of 95% standard Proctor maximum density in 150mm to 200mm lifts. A shrinkage factor of about 25% should be used in calculating volumes of material to be used.
4. The unsuitable material can be used as backfill on the outside face of the dykes. The embankment material should be placed in 150mm lifts compacted with at least eight passes with a sheepsfoot roller.

Further erosion control against wind and rain action using riprap placement on the dykes should be provided, if needed, after construction. A well-developed and maintained grass cover above the riprap should add integrity to the dykes.

The entire completed pond system should be fenced to keep people, children in particular away from the pond. All gates should be locked to prevent access.

Appropriate warning signs should be provided on the fence around the pond, to designate the nature of the facility, and advice against trespassing.

We recommend that a minimum distance of 5 meters be maintained between the outside toe of the embankment and the fence.

7.0 ADDITIONAL CONSIDERATIONS (PROPOSED TANK FOUNDATION, EXCAVATION AND LATERAL PRESSURE AND ACCESS ROADS)

PROPOSED TANK FOUNDATION

The proposed tank (15m x 6.7m) may be supported by a reinforced concrete raft slab foundation founded on 600mm of engineered fill over stiff to firm clay at a depth of 4.7m below grade. To reduce differential foundation settlement, the thickened edge slab should be prepared as follows:

- Within the proposed building area and at least 1.2m (4 ft) beyond the tank perimeter, remove all softened soil and ponded water to expose the underlying firm brown clay. Depth of site stripping is expected to be at least 5.3m below grade (4.7m below grade plus an extra 600mm depth to be replaced with compacted fill).
- *Call for subgrade inspection and approval of the exposed stiff to firm clay by qualified geotechnical personnel. The slab should be founded on 600mm compacted granular fill over clay. Ensure that the subgrade soil maintains its moisture content to reduce shrinkage and swelling potential.*
- Once the subgrade is approved, compact the subgrade uniformly with a heavy vibratory roller to at least 95% Standard Proctor density (ASTM D698). Place a non-woven geotextile on top of the clay followed by 450mm of 100mm down clean, crushed limestone then by 150mm thick of 19mm down base course material. The base course material should be uniformly compacted to at least 98%

Standard Proctor density (ASTM D698). Apply a skim coat to compacted base course material. All aggregate material used should passed the Manitoba Infrastructure and Transportation specification.

- To maintain lateral earth pressures against foundation walls, place non-frost susceptible (pit-run aggregate) around the perimeter and extending at least 1.2m beyond the edges of the raft foundation.

Using a Factor of Safety of 3.0, the proposed raft should be built on compacted granular fill at 4.7m below grade. On the foregoing basis and contingent upon a minimum width of 400mm for the slab thickness, an allowable soil bearing pressure of 95.7 kPa (2000 psf) may be used.

With Limit State Design (LSD), the following bearing resistances at Unfactored Ultimate Limit State (ULS) and Serviceability Limit State (SLS) are recommended for this foundation system; Factored ULS: 114.9 kPa (2400 psf) and SLS: 95.7 kPa (2000 psf). Note that the appropriate resistance factor of 0.4 was applied to the Unfactored ULS for a Factored ULS determination.

The associated total soil settlement is estimated to be 25 to 50mm.

The intention is to empty this tankage by the end of October and fill it again by June of the following year. The anticipated total liquid weight is 270,000 kg. To prevent the tank from lifting due to rebound, provide additional weight (concrete) twice the weight of the liquid around the reservoir. This is to counteract the anticipated annual lifting of the reservoir. Otherwise, this reservoir could be supported by a system of deep foundation system (cast-in-place friction piles) if movement is not tolerated.

To avoid potential long term settlement caused by the roots of fast growing trees, all existing and new trees should be offset from the edges of the thickened slab, a minimum horizontal distance equal to the tree's mature height.

EXCAVATION AND LATERAL EARTH PRESSURE

Excavations entirely within the clay at this site would likely remain stable at slopes of up to 1H:3V over the short term. To limit spalling effects and sloughing conditions, excavation slopes should be covered by tarpaulins to reduce weathering. If workers are expected to be within the excavation, side slopes not steeper than 1H: 1V should be maintained. Workplace Health & Safety rules should be followed at all times.

The design of the walls should be capable of resisting earth pressure based on the following formula:

$$P = K_o (\delta H + q)$$

where: P = horizontal earth pressure at depth H (kPa)

K_o = earth pressure coefficient (0.5)

δ = soil unit weight (16.5 kN/m³)

H = height of soil against wall (m)

q = surcharge at ground surface within distance H of excavation wall (kPa)

It is assumed that the groundwater table will be lower than the bottom of the tank. A foundation weeping tile drainage system should be provided to ensure this. It is recommended that excavation slopes be located at least a distance H away from settlement sensitive structures, where H is the depth of cut for vertical walls.

ACCESS ROAD

On the basis of the soil conditions encountered during drilling (i.e. mainly a brown clay subgrade), the recommended road pavement construction at this site should be as follows:

Pavement Thicknesses

	Truck Route	% Compaction
Base Coarse	150 mm	100% Std Proctor
Subbase	225 mm	100% Std Proctor

The above pavement sections should be constructed on a prepared stiff clay subgrade, which should be free of any fibrous organics, softened and disturbed soils. The average depth of site stripping is about 100 to 200mm below ground surface. The prepared subgrade should be proof rolled with a heavy sheepsfoot roller (min. 20 passes) which translates to at least 95% Std Proctor and inspected by a qualified geotechnical engineer prior to the placement of the overlying granular fill.

The granular base course and subbase materials should include organic-free, non-frozen, aggregate conforming to the Manitoba Infrastructure and Transportation gradation limits.

Where soft spots are encountered at the subgrade level, construction traffic should be restricted. Soft spots should be excavated with a large backhoe fitted with a smooth bucket, to at least 300mm below the underside of the subbase and replaced with a 300mm thick layer of 100mm down crushed aggregate/limestone. In this regard, the total granular fill thickness would be 675mm for truck access.

Sieve analysis and compaction testing of the granular base and subbase materials should be conducted by qualified geotechnical personnel to ensure that the materials supplied and percent compactions are in accordance with design specifications.

8.0 STANDARD LIMITATIONS

The factual data, interpretations and recommendations contained in this report pertain to the specific project as described in this report and are not applicable to any other project, site location or party. The comments given in this report are intended only for the guidance of the design engineer. Contractors bidding on, or undertaking the work, should rely on their own investigations, as well as their own interpretations of the factual test data, as to how subsurface conditions may affect their work.

Soil descriptions in this report are based on commonly accepted methods of classification and identification employed in professional geotechnical practice. Classification and identification of soil involves judgement and WSP Canada Inc. does

not guarantee descriptions as exact, but infers accuracy only to the extent that is common in current geotechnical practice.

Soil formations are variable to a greater or lesser extent. The testhole logs indicate the approximate subsurface conditions only at the locations of the testhole. Boundaries between zones on the logs are often not distinct, but rather transitional, and have been interpreted. Subsurface conditions between test holes are inferred and may vary significantly from conditions encountered at the testhole.

Where conditions encountered at the site differ significantly from those anticipated in the report, either due to natural variability of subsurface conditions or construction activities, it is a condition of the use, or reliance by the client, of this report that WSP Canada Inc. is notified of the changes and provided with an opportunity to review the recommendations of this report.

Prepared by: S.S. Urbano Jr., P. Eng.



APPENDIX A

SITE PLAN AND SLOPE MODELS



TRANSCANADA PIPELINES
RIGHT-OF-WAY

PT RIVER LOT 9

TH1 TH2

TH4 TH3

PRIMARY
CELL NO. 1
(AERATED)

SECONDARY
CELL NO. 1

PRIMARY
CELL NO. 2
(AERATED)

PT RIVER LOT 7

SECONDARY
CELL NO. 2

PT SE 33 - 8 - 5 E.P.M.

TH5

PT RIVER LOT 8

TH11

TH8

TH10

TH6

TH7

TH9

Diversion Rd

SEINE RIVER DIVERSION



1600 BUFFALO PLACE
WINNIPEG, MANITOBA
CANADA R3T 6B8
PHONE: 204-477-6650 FAX : 204-474-2864
WWW.WSPGROUP.COM

TITLE:

EXISTING SITE PLAN
WITH TESTHOLES

SCALE:

NTS

DATE:

2015/07/16

PROJECT NO:

151-01887-00

REVISION:

0

DRAWING NO:

Figure 1

XREF

STAMP

Lorette Lagoon - Aerated Primary Cell

Slope Stability - 1 Year in Operation

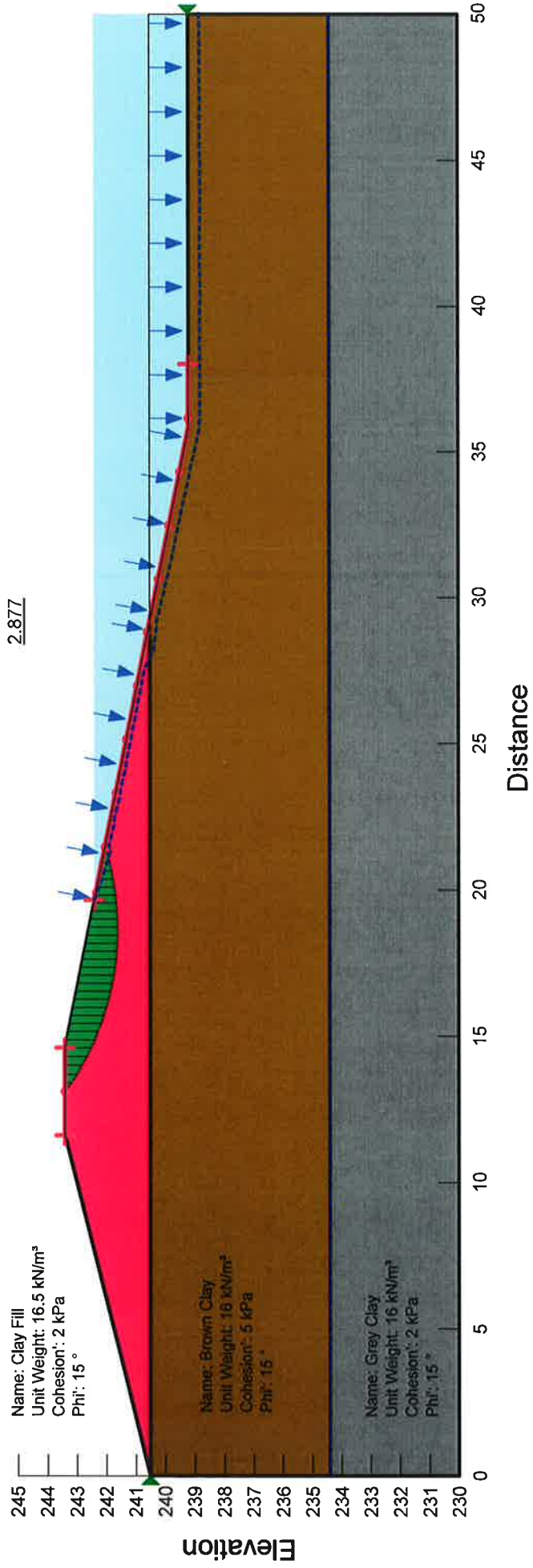

Figure 2

Lorette Lagoon - Aerated Primary Cell

Coupled Stress w/ PWP - 1 Year in Operation

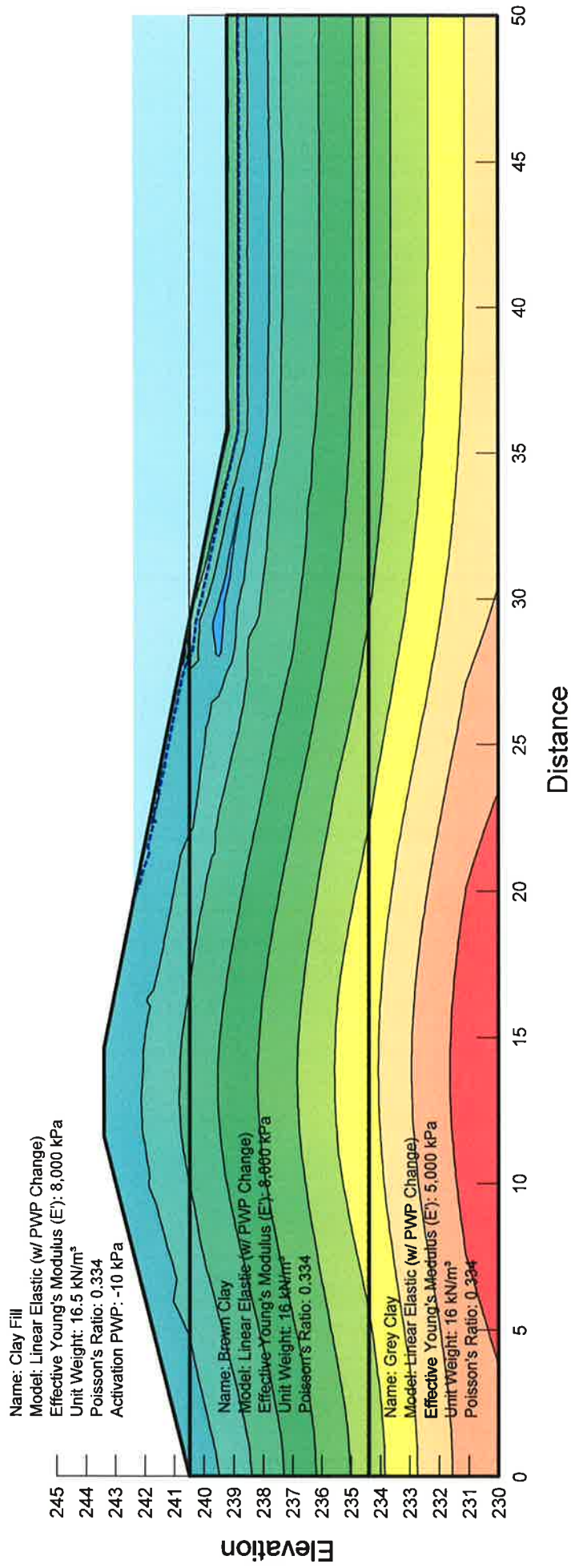

Figure 3

Lorette Lagoon - Aerated Primary Cell

Slope Stability - 7 Day Rapid Drawdown

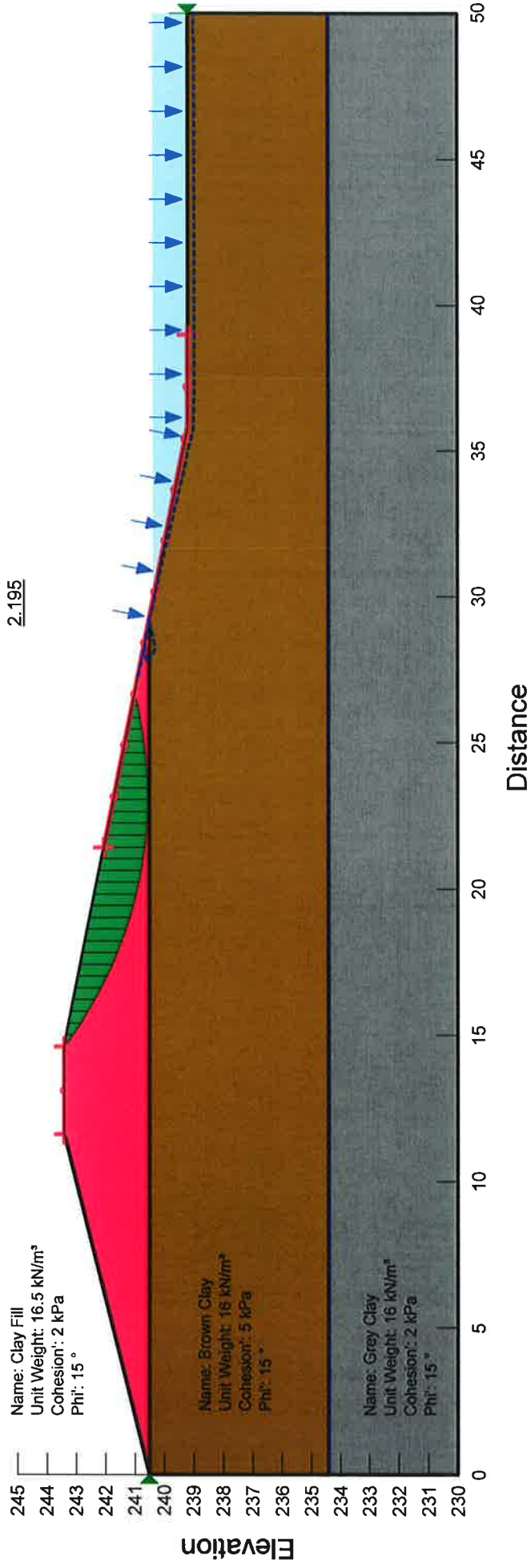

Figure 4

Lorette Lagoon - Aerated Primary Cell

Coupled Stress w/ PWP - 7 Day Rapid Drawdown

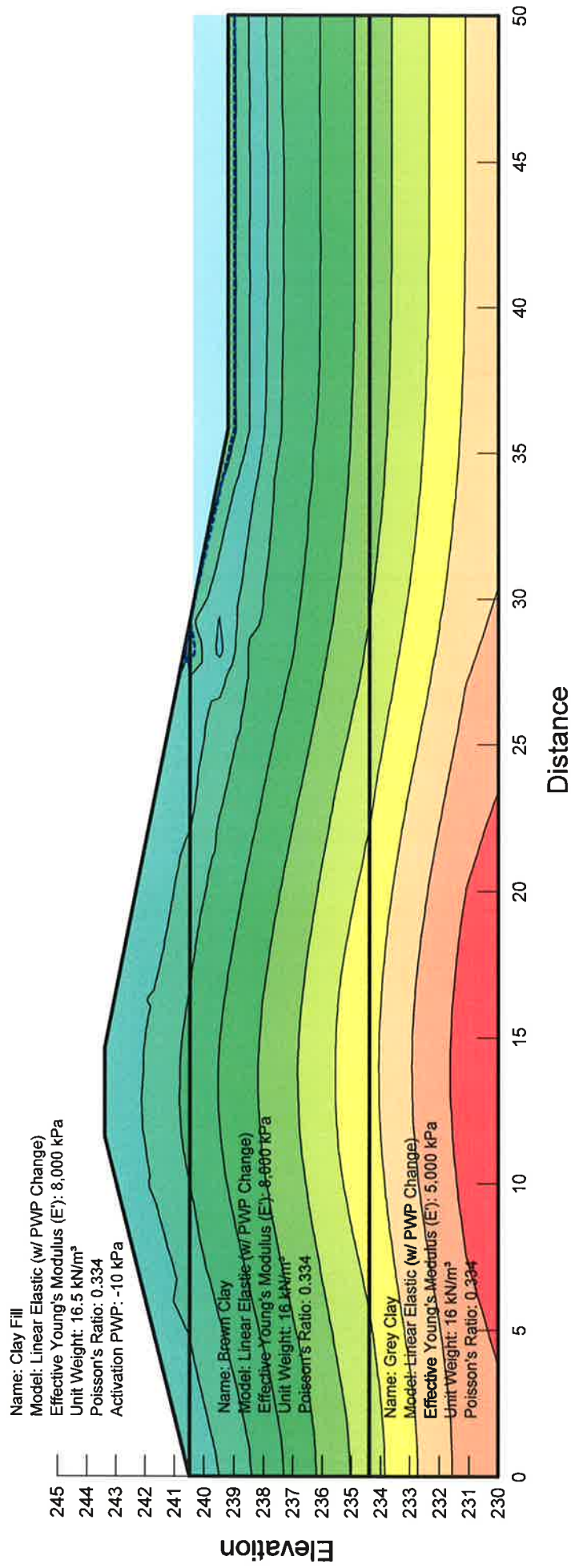

Figure 5

APPENDIX B

TESTHOLE LOGS and WELL LOGS



WSP Canada Inc.
 1600 Buffalo Place,
 Winnipeg, MB R3T 6B8
 (204) 477-6650

CLIENT LORETTE PROJECT NAME LORETTE WWSP EXPANSION
 PROJECT NUMBER 151-01887-00 PROJECT LOCATION LORETTE, MB
 DATE STARTED 17/4/15 COMPLETED 17/4/15 GROUND ELEVATION 240.5 m HOLE SIZE 125 mm
 DRILLING CONTRACTOR MAPLE LEAF ENTERPRISES GROUND WATER LEVELS:
 DRILLING METHOD CONTINUOUS AUGER AT TIME OF DRILLING ---
 LOGGED BY G. Baggao CHECKED BY S.U. AT END OF DRILLING ---
 NOTES AFTER DRILLING ---

DEPTH (m)	GRAPHIC LOG	MATERIAL DESCRIPTION	TESTS AND REMARKS	BLOW COUNTS (N VALUE)	POCKET PEN. (kPa)	MOISTURE CONTENT (%)	▲ SPT N VALUE ▲													
							20	40	60	80										
0.20		TOPSOIL 200 mm MIXED WITH ROOTLETS; FROST TO 1.5m																		
1.0		CLAY GREY-BLACK, FISSURED BROWN @ 0.61 m, HIGH PLASTICITY CLAY GREY @ 6.40 m	PP = 100 kPa @ 1.5 m		100															
3.0			PP = 100 kPa @ 3.0 m		100															
4.6			PP = 100 kPa @ 4.6 m		100															
6.1			PP = 50 kPa @ 6.1 m		50															
7.62		Bottom of hole at 7.62 m.	PP = 50 kPa @ 7.6 m		50															

WSP CANADA INC. (METRIC) LORETTE(METRIC) GPJ GINT STD CANADA GDT 29/6/15



WSP Canada Inc.
 1600 Buffalo Place,
 Winnipeg, MB R3T 6B8
 (204) 477-6650

CLIENT LORETTE PROJECT NAME LORETTE WWSP EXPANSION
 PROJECT NUMBER 151-01887-00 PROJECT LOCATION LORETTE, MB
 DATE STARTED 17/4/15 COMPLETED 17/4/15 GROUND ELEVATION 240.5 m HOLE SIZE 125 mm
 DRILLING CONTRACTOR MAPLE LEAF ENTERPRISES GROUND WATER LEVELS:
 DRILLING METHOD CONTINUOUS AUGER AT TIME OF DRILLING ---
 LOGGED BY G. Baggao CHECKED BY S.U. AT END OF DRILLING ---
 NOTES AFTER DRILLING ---

DEPTH (m)	GRAPHIC LOG	MATERIAL DESCRIPTION	TESTS AND REMARKS	BLOW COUNTS (N VALUE)	POCKET PEN. (kPa)	MOISTURE CONTENT (%)	▲ SPT N VALUE ▲			
							20	40	60	80
							PL	MC	LL	
							□ FINES CONTENT (%) □			
							20	40	60	80
							20	40	60	80
0.10		TOPSOIL 100 mm THICK, LOOSE, ROOTLETS WITH CLAYEY LOAM CLAY								
2.0		GREY-BLACK, STIFF, FISSURED SILTY @ 0.9 m, TAN-BROWN CLAYEY BELOW 1.5 m GREY-BROWN @ 5.5 m TEST HOLE IS DRY AFTER COMPLETION OF DRILLING	PP = 125 kPa @ 1.5 m		125					
4.0			PP = 125 kPa @ 3.0 m		125					
6.0			PP = 70 kPa @ 4.6 m		70					
8.0			PP = 50 kPa @ 6.1 m		50					
9.14			PP = 25 kPa @ 7.6 m		25					
		Bottom of hole at 9.14 m.	PP = 25 kPa @ 9.1 m		25					

WSP CANADA INC. (METRIC) LORETTE (METRIC) GPJ GINT STD CANADA, GDT 29/05/15



WSP Canada Inc.
1600 Buffalo Place,
Winnipeg, MB R3T 6B8
(204) 477-6650

TH4

PAGE 1 OF 1

CLIENT LORETTE PROJECT NAME LORETTE WWSP EXPANSION
 PROJECT NUMBER 151-01887-00 PROJECT LOCATION LORETTE, MB
 DATE STARTED 17/4/15 COMPLETED 17/4/15 GROUND ELEVATION 240.5 m HOLE SIZE 125 mm
 DRILLING CONTRACTOR MAPLE LEAF ENTERPRISES GROUND WATER LEVELS:
 DRILLING METHOD CONTINUOUS AUGER AT TIME OF DRILLING ---
 LOGGED BY G. Baggao CHECKED BY S.U. AT END OF DRILLING ---
 NOTES _____ AFTER DRILLING ---

DEPTH (m)	GRAPHIC LOG	MATERIAL DESCRIPTION	TESTS AND REMARKS	BLOW COUNTS (N VALUE)	POCKET PEN. (kPa)	MOISTURE CONTENT (%)	▲ SPT N VALUE ▲												
							20	40	60	80									
		0.15 TOPSOIL 240.35																	
		150 mm THICK, LOOSE, ROOTLETS WITH CLAYEY LOAM CLAY																	
2.0		BROWN, FISSURED FROST TO 1.0 m; STIFF BELOW 1.0 m SOFT BELOW 7.6 m; GREY BELOW 7.6 m TEST HOLE IS DRY AFTER COMPLETION OF DRILLING	PP = 225 kPa @ 1.5 m		225														
4.0			PP = 100 kPa @ 3.0 m		100														
			PP = 50 kPa @ 4.6 m		50														
6.0			PP = 60 kPa @ 6.1 m		60														
8.0			PP = 25 kPa @ 7.6 m		25														
		9.14 Bottom of hole at 9.14 m. 231.36	PP = 20 kPa @ 9.1 m		20														

WSP CANADA INC. (METRIC) LORETTE(METRIC).GPJ GINT STD CANADA.GDT 20/6/15



WSP Canada Inc.
1600 Buffalo Place,
Winnipeg, MB R3T 6B8
(204) 477-6650

TH5

PAGE 1 OF 1

CLIENT LORETTE PROJECT NAME LORETTE WWSP EXPANSION
 PROJECT NUMBER 151-01887-00 PROJECT LOCATION LORETTE, MB
 DATE STARTED 17/4/15 COMPLETED 17/4/15 GROUND ELEVATION 240.5 m HOLE SIZE 125 mm
 DRILLING CONTRACTOR MAPLE LEAF ENTERPRISES GROUND WATER LEVELS:
 DRILLING METHOD CONTINUOUS AUGER AT TIME OF DRILLING ---
 LOGGED BY G. Baggao CHECKED BY S.U. AT END OF DRILLING ---
 NOTES AFTER DRILLING ---

DEPTH (m)	GRAPHIC LOG	MATERIAL DESCRIPTION	TESTS AND REMARKS	BLOW COUNTS (N VALUE)	POCKET PEN. (kPa)	MOISTURE CONTENT (%)	▲ SPT N VALUE ▲			
							20	40	60	80
							PL	MC	LL	
							□ FINES CONTENT (%) □			
							20	40	60	80
0.13		TOPSOIL 50 mm THICK, LOOSE, ROOTLETS WITH CLAYEY LOAM CLAY BROWN, HIGH PLASTICITY TRACE OF SILT INCLUSIONS BETWEEN 1.5 m TO 1.8 m HIGH PLASTICITY BELOW 1.8 m GREY @ 4.3 m. TESTHOLE IS DRY AFTER COMPLETION OF DRILLING.								
240.37										
1.0										
2.0										
3.0			PP = 100 kPa @ 3.0 m		100					
4.0										
4.57		Bottom of hole at 4.57 m.	PP = 50 kPa @ 4.6 m		50					
235.93										

WSP CANADA INC. (METRIC) LORETTE (METRIC) GPJ_GINT STD CANADA_GDT_16/7/15



WSP Canada Inc.
 1600 Buffalo Place,
 Winnipeg, MB R3T 6B8
 (204) 477-6650

TH6

PAGE 1 OF 1

CLIENT LORETTE PROJECT NAME LORETTE WWSP EXPANSION
 PROJECT NUMBER 151-01887-00 PROJECT LOCATION LORETTE, MB
 DATE STARTED 17/4/15 COMPLETED 17/4/15 GROUND ELEVATION 240.5 m HOLE SIZE 125 mm
 DRILLING CONTRACTOR MAPLE LEAF ENTERPRISES GROUND WATER LEVELS:
 DRILLING METHOD CONTINUOUS AUGER AT TIME OF DRILLING ---
 LOGGED BY G. Baggao CHECKED BY S.U. AT END OF DRILLING ---
 NOTES _____ AFTER DRILLING ---

DEPTH (m)	GRAPHIC LOG	MATERIAL DESCRIPTION	TESTS AND REMARKS	BLOW COUNTS (N VALUE)	POCKET PEN. (kPa)	MOISTURE CONTENT (%)	▲ SPT N VALUE ▲			
							20	40	60	80
		<p>TOPSOIL 0.15</p> <p>FROST TO 127 mm</p> <p>CLAY BROWN, HIGH PLASTICITY</p> <p>TEST HOLE IS DRY AFTER COMPLETION OF DRILLING.</p>								
1.0										
2.0										
3.0										
4.0										
4.57		Bottom of hole at 4.57 m.								

WSP CANADA INC. (METRIC) LORETTE(METRIC).GPJ (GINT STD CANADA GDT 16/7/15

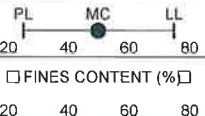



WSP Canada Inc.
 1600 Buffalo Place,
 Winnipeg, MB R3T 6B8
 (204) 477-6650

CLIENT LORETTE PROJECT NAME LORETTE WWSP EXPANSION
 PROJECT NUMBER 151-01887-00 PROJECT LOCATION LORETTE, MB
 DATE STARTED 17/4/15 COMPLETED 17/4/15 GROUND ELEVATION 240.5 m HOLE SIZE 125 mm
 DRILLING CONTRACTOR MAPLE LEAF ENTERPRISES GROUND WATER LEVELS:
 DRILLING METHOD CONTINUOUS AUGER AT TIME OF DRILLING ---
 LOGGED BY G. Baggao CHECKED BY S.U. AT END OF DRILLING ---
 NOTES _____ AFTER DRILLING ---

DEPTH (m)	GRAPHIC LOG	MATERIAL DESCRIPTION	TESTS AND REMARKS	BLOW COUNTS (N VALUE)	POCKET PEN. (kPa)	MOISTURE CONTENT (%)	▲ SPT N VALUE ▲	
							20 40 60 80	20 40 60 80
							PL	MC LL
							□ FINES CONTENT (%) □	
							20 40 60 80	20 40 60 80
0.20		TOPSOIL						
240.30		CLAY BROWN FROST TO 1.5 m; SILTY BETWEEN 1.2 m TO 1.8 m CLAYEY BELOW 1.8 m; HIGH PLASTICITY						
4.57		Bottom of hole at 4.57 m.						
			PP = 100 kPa @ 4.6 m		100			

WSP CANADA INC. (METRIC) LORETTE(METRIC).GPJ GINT STD CANADA GDT 16/7/15



WSP Canada Inc.
1600 Buffalo Place,
Winnipeg, MB R3T 6B8
(204) 477-6650

TH8

PAGE 1 OF 1

CLIENT LORETTE PROJECT NAME LORETTE WWSP EXPANSION
 PROJECT NUMBER 151-01887-00 PROJECT LOCATION LORETTE, MB
 DATE STARTED 17/4/15 COMPLETED 17/4/15 GROUND ELEVATION 240.5 m HOLE SIZE 125 mm
 DRILLING CONTRACTOR MAPLE LEAF ENTERPRISES GROUND WATER LEVELS:
 DRILLING METHOD CONTINUOUS AUGER AT TIME OF DRILLING ---
 LOGGED BY G. Baggao CHECKED BY S.U. AT END OF DRILLING ---
 NOTES _____ AFTER DRILLING ---

DEPTH (m)	GRAPHIC LOG	MATERIAL DESCRIPTION	TESTS AND REMARKS	BLOW COUNTS (N VALUE)	POCKET PEN. (kPa)	MOISTURE CONTENT (%)	▲ SPT N VALUE ▲													
							20	40	60	80										
0.15		TOPSOIL																		
0.15		CLAY																		
1.0		FROST TO 1.5 m; BROWN, FISSURED STIFF BELOW 1.5 m GREY BELOW 5.5 m																		
2.0		TEST HOLE IS DRY AFTER COMPLETION OF DRILLING	PP = 100 kPa @ 1.5 m		100															
3.0			PP = 100 kPa @ 3.0 m		100															
4.0			PP = 75 kPa @ 4.6 m		75															
5.0			PP = 70 kPa @ 6.1 m		70															
6.0																				
7.0																				
7.62		Bottom of hole at 7.62 m.	PP = 70 kPa @ 7.6 m		70															

WSP CANADA INC. (METRIC) LORETTE (METRIC) GPJ GINT STD CANADA GDT 16/7/15



WSP Canada Inc.
 1600 Buffalo Place,
 Winnipeg, MB R3T 6B8
 (204) 477-6650

CLIENT LORETTE PROJECT NAME LORETTE WWSP EXPANSION
 PROJECT NUMBER 151-01887-00 PROJECT LOCATION LORETTE, MB
 DATE STARTED 17/4/15 COMPLETED 17/4/15 GROUND ELEVATION 240.5 m HOLE SIZE 125 mm
 DRILLING CONTRACTOR MAPLE LEAF ENTERPRISES GROUND WATER LEVELS:
 DRILLING METHOD CONTINUOUS AUGER AT TIME OF DRILLING ---
 LOGGED BY G. Baggao CHECKED BY S.U. AT END OF DRILLING ---
 NOTES _____ AFTER DRILLING ---

DEPTH (m)	GRAPHIC LOG	MATERIAL DESCRIPTION	TESTS AND REMARKS	BLOW COUNTS (N VALUE)	POCKET PEN. (kPa)	MOISTURE CONTENT (%)	▲ SPT N VALUE ▲												
							20	40	60	80									
0.20		TOPSOIL																	
240.30		CLAY GREY, BLACK, FISSURED SILTY @ 0.6 m, TAN-BROWN FROST TO 1.7 m; HIGH PLASTICITY @ 3.4 m, BROWN.																	
1.0																			
2.0																			
3.0																			
4.0																			
4.57		Bottom of hole at 4.57 m.																	

WSP CANADA INC. (METRIC) LORETTE (METRIC) GPJ GINT STD CANADA GDT 16/7/15

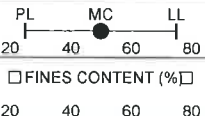



WSP Canada Inc.
 1600 Buffalo Place,
 Winnipeg, MB R3T 6B8
 (204) 477-6650

TH10

PAGE 1 OF 1

CLIENT LORETTE PROJECT NAME LORETTE WWSP EXPANSION
 PROJECT NUMBER 151-01887-00 PROJECT LOCATION LORETTE, MB
 DATE STARTED 17/4/15 COMPLETED 17/4/15 GROUND ELEVATION 240.5 m HOLE SIZE 125 mm
 DRILLING CONTRACTOR MAPLE LEAF ENTERPRISES GROUND WATER LEVELS:
 DRILLING METHOD CONTINUOUS AUGER AT TIME OF DRILLING ---
 LOGGED BY G. Baggao CHECKED BY S.U. AT END OF DRILLING ---
 NOTES AFTER DRILLING ---

DEPTH (m)	GRAPHIC LOG	MATERIAL DESCRIPTION	TESTS AND REMARKS	BLOW COUNTS (N VALUE)	POCKET PEN. (kPa)	MOISTURE CONTENT (%)	▲ SPT N VALUE ▲	
							PL	MC LL
							20 40 60 80	20 40 60 80
							□ FINES CONTENT (%) □	
							20 40 60 80	20 40 60 80
0.15		TOPSOIL						
		75 mm ROOTS						
		FROST TO 0.8 m						
		CLAY						
2.0		BROWN, FISSURED	PP = 150 kPa @ 1.5 m		150			
		STIFF BELOW 0.8 m						
		GREY @ 4.6 m						
4.0		TEST HOLE IS DRY AFTER COMPLETION OF DRILLING	PP = 100 kPa @ 3.0 m		100			
6.0			PP = 85 kPa @ 4.6 m		85			
8.0			PP = 85 kPa @ 6.1 m		85			
10.0			PP = 50 kPa @ 9.1 m		50			
12.0			PP = 40 kPa @ 10.7 m		40			
12.19		Bottom of hole at 12.19 m.	PP = 40 kPa @ 12.2 m		40			

WSP CANADA INC. (METRIC) LORETTE (METRIC) GPJ GINT STD CANADA GDT 16/7/15



WSP Canada Inc.
1600 Buffalo Place,
Winnipeg, MB R3T 6B8
(204) 477-6650

TH11

PAGE 1 OF 1

CLIENT LORETTE PROJECT NAME LORETTE WWSP EXPANSION
 PROJECT NUMBER 151-01887-00 PROJECT LOCATION LORETTE, MB
 DATE STARTED 17/4/15 COMPLETED 17/4/15 GROUND ELEVATION 240.5 m HOLE SIZE 125 mm
 DRILLING CONTRACTOR MAPLE LEAF ENTERPRISES GROUND WATER LEVELS:
 DRILLING METHOD CONTINUOUS AUGER AT TIME OF DRILLING ---
 LOGGED BY G. Baggao CHECKED BY S.U. AT END OF DRILLING ---
 NOTES _____ AFTER DRILLING ---

DEPTH (m)	GRAPHIC LOG	MATERIAL DESCRIPTION	TESTS AND REMARKS	BLOW COUNTS (N VALUE)	POCKET PEN. (kPa)	MOISTURE CONTENT (%)	▲ SPT N VALUE ▲												
							20	40	60	80									
0.15		TOPSOIL																	
0.15		CLAY GREY-BLACK, FISSURED BROWN @ 0.9 m FROST TO 1.2 m; STIFF BELOW 1.2 m, HIGH PLATICITY TESTHOLE IS DRY AFTER COMPLETION OF DRILLING.																	
0.5																			
1.0																			
1.5			PP = 125 kPa @ 1.5 m		125														
2.0																			
2.5																			
3.0																			
3.05		Bottom of hole at 3.05 m.	PP = 100 kPa @ 3.0 m		100														

WSP CANADA INC. (METRIC) LORETTE(METRIC) GPJ GINT STD CANADA GDT 16/7/15

LOCATION: RIVER LOT 0008 IN PARISH OF Lorette

Owner: MAURICE LAVERGNE
Driller: Echo Drilling Ltd.
Well Name: EAST WELL
Well Use: PRODUCTION
Water Use: Domestic
Date Completed: 2002 Nov 08

WELL LOG

From	To	Log
(ft.)	(ft.)	
0	50.0	CLAY
50.0	65.0	TILL
65.0	135.0	LIMESTONE

WELL CONSTRUCTION

From	To	Casing	Inside	Outside	Slot	Type
Material	(ft.)	(ft.) Type	Dia.(in)	Dia.(in)	Size(in)	
	0	68.0 CASING	5.00	5.50		INSERT PVC
	68.0	135.0 OPEN HOLE	4.00			
	20.0	60.0 CASING GROUT				

CEMENT

Top of Casing: 2.0 ft. above ground

PUMPING TEST

Date: 2002 Nov 08
Pumping Rate: 50.0 Imp. gallons/minute
Water level before pumping: 24.0 ft. below ground
Pumping level at end of test: 60.0 ft. below ground
Test duration: ??? hours, ?? minutes
Water temperature: ?? degrees F

LOCATION: RIVER LOT 0008 IN PARISH OF Lorette

Owner: MAURICE LAVERGNE
Driller: Echo Drilling Ltd.
Well Name: NORTH WELL
Well Use: PRODUCTION
Water Use: Domestic
Date Completed: 2002 Nov 08

WELL LOG

From (ft.)	To (ft.)	Log
0	50.0	CLAY
50.0	71.0	TILL
71.0	135.0	LIMESTONE

WELL CONSTRUCTION

From Material (ft.)	To (ft.)	Casing Type	Inside Dia. (in)	Outside Dia. (in)	Slot Size (in)	Type
0	73.0	CASING	5.00	5.50		INSERT PVC
73.0	135.0	OPEN HOLE	4.00			
20.0	60.0	CASING GROUT CEMENT				

Top of Casing: 2.0 ft. above ground

PUMPING TEST

Date: 2002 Nov 08
Pumping Rate: 50.0 Imp. gallons/minute
Water level before pumping: 24.0 ft. below ground
Pumping level at end of test: 60.0 ft. below ground
Test duration: ??? hours, ?? minutes
Water temperature: ?? degrees F

LOCATION: RIVER LOT 8 IN PARISH OF Lorette

Owner: J PROULY
Driller: mondor drillers
Well Name:
Well Use: PRODUCTION
Water Use: Domestic
Date Completed: 1965 Aug 23

WELL LOG

From (ft.)	To (ft.)	Log
0	21.0	BROWN CLAY
21.0	54.0	BLUE CLAY
54.0	63.0	HARDPAN
63.0	69.0	SAND
69.0	86.9	FINE GRAVEL, WATER AT 82 FEET
86.9	100.9	LIMESTONE

100.9 120.9 WHITE LIMESTONE, WATER AT 112 AND 121 FEET

WELL CONSTRUCTION

From Material (ft.)	To (ft.)	Casing Type	Inside Dia.(in)	Outside Dia.(in)	Slot Size(in)	Type
0	86.9	casing	4.00			
86.9	120.9	open hole				

Top of Casing: ft. below ground

PUMPING TEST

Date:

Pumping Rate: 20.0 Imp. gallons/minute

Water level before pumping: ft. below ground

Pumping level at end of test: 19.0 ft. below ground

Test duration: 1 hours, minutes

Water temperature: ?? degrees F

REMARKS

E OF DAWSON ST AND 220 FT S OF REHAULT ST, GROUND LEVEL ELEV EST 780 FT

LOCATION: RIVER LOT 8 IN PARISH OF Lorette

Owner: D CHAMPAGNE

Driller: Echo Drilling Ltd.

Well Name:

Well Use: PRODUCTION

Water Use: Domestic

Date Completed: 1996 Sep 16

WELL LOG

From (ft.)	To (ft.)	Log
0	23.0	BROWN CLAY
23.0	52.0	GREY CLAY
52.0	71.0	TILL
71.0	118.0	LIMESTONE

WELL CONSTRUCTION

From Material (ft.)	To (ft.)	Casing Type	Inside Dia.(in)	Outside Dia.(in)	Slot Size(in)	Type
---------------------------	-------------	----------------	--------------------	---------------------	------------------	------

0	73.0	CASING	5.00	INSERT	PVC
73.0	118.0	OPEN HOLE	4.00		
0	73.0	CASING GROUT			

BENTONITE

Top of Casing: 1.0 ft. above ground

PUMPING TEST

Date:
Pumping Rate: 20.0 Imp. gallons/minute
Water level before pumping: 35.0 ft. below ground
Pumping level at end of test: 50.0 ft. below ground
Test duration: ??? hours, ?? minutes
Water temperature: ?? degrees F

LOCATION: RIVER LOT 8 IN PARISH OF Lorette

Owner: GREG FAST
Driller: Echo Drilling Ltd.
Well Name:
Well Use: PRODUCTION
Water Use: Domestic
Date Completed: 1997 Mar 18

WELL LOG

From (ft.)	To (ft.)	Log
0	50.0	CLAY
50.0	83.0	TILL
83.0	269.0	LIMESTONE
269.0	278.0	SHALE
278.0	318.0	SANDSTONE

WELL CONSTRUCTION

From Material (ft.)	To (ft.)	Casing Type	Inside Dia. (in)	Outside Dia. (in)	Slot Size (in)	Type
0	88.0	CASING	5.00			INSERT PVC
86.0	246.0	CASING	2.00			INSERT PVC
246.0	318.0	OPEN HOLE	4.00			
0	88.0	CASING GROUT				

BENTONITE

Top of Casing: 2.0 ft. above ground

PUMPING TEST

APPENDIX C

LABORATORY TEST RESULTS

**MOISTURE CONTENT OF SOIL
 ASTM D2216**

CLIENT:	WSP	TEST NO:	1	PROJECT NO:	1502-7
PROJECT:	Lorette	DATE SAMPLED:	unknown	SAMPLED BY:	SU
PROJECT CONTACT:	SU	DATE TESTED:	20-Apr-15	TESTED BY:	GM/GP
Test Hole No.	TH3	TH3	TH3	TH3	TH3
Depth	5'	10'	15'	20'	25'
Wt Wet Sample + Tare	727.4	112.2	116.8	102.4	113.4
Wt Dry Sample + Tare	616.6	75.6	77	69.7	74.1
Wt Water	110.8	36.6	39.8	32.7	39.3
Wt Tare	248.8	4.3	4.3	4.3	4.1
Wt Dry Sample	367.8	71.3	72.7	65.4	70.0
Moisture Content (%)	30.1	51.3	54.7	50.0	56.1
Test Hole No.	TH3		TH8	TH8	TH8
Depth	30'		2.5'	5'	10'
Wt Wet Sample + Tare	114.2		1057.3	136.5	129.9
Wt Dry Sample + Tare	71.3		863.7	97.9	84
Wt Water	42.9		193.6	38.6	45.9
Wt Tare	4.2		309.7	4.5	4.3
Wt Dry Sample	67.1		554.0	93.4	79.7
Moisture Content (%)	63.9		34.9	41.3	57.6
Test Hole No.	TH8	TH8	TH8		TH9
Depth	15'	20'	25'		10'
Wt Wet Sample + Tare	132.7	100.5	110.6		102.8
Wt Dry Sample + Tare	86	66	72.8		80
Wt Water	46.7	34.5	37.8		22.8
Wt Tare	4.4	4.6	4.5		4.6
Wt Dry Sample	81.6	61.4	68.3		75.4
Moisture Content (%)	57.2	56.2	55.3		30.2
Test Hole No.					
Depth					
Wt Wet Sample + Tare					
Wt Dry Sample + Tare					
Wt Water					
Wt Tare					
Wt Dry Sample					
Moisture Content (%)					

MOISTURE CONTENT OF SOIL (ASTM D2216)

CLIENT: WSP Group	TEST NO: 1	PROJECT NO: 1502 - 7
PROJECT: Lorette	DATE SAMPLED:	SAMPLED BY: Client
PROJECT CONTACT: SU	DATE TESTED: May 4, 2015	TESTED BY: GM / GP

Test Hole No. LORETTE	4	4	4	4	4
Depth	5 ft	10 ft	15 ft	20 ft	25 ft
Tare No.					
Wt Wet Sample + Tare	206.2	193.8	162.1	128.8	214.9
Wt Dry Sample + Tare	157.8	153.5	128.1	107.6	186.6
Wt Water	48.4	40.3	34	21.2	28.3
Wt Tare	4.2	4.2	4.2	4.2	4.2
Wt Dry Sample	153.6	149.3	123.9	103.4	182.4
Moisture Content (%)	31.5	27.0	27.4	20.5	15.5
Test Hole No. LORETTE	4	4			
Depth	30 ft	35 ft			
Tare No.					
Wt Wet Sample + Tare	211.5	148.5			
Wt Dry Sample + Tare	187.1	133.9			
Wt Water	24.4	14.6			
Wt Tare	4.2	4.2			
Wt Dry Sample	182.9	129.7			
Moisture Content (%)	13.3	11.3			

UNIT WEIGHT - SAMPLE FROM SHELBY TUBES (LORETTE)						
TH3 at 5 ft.						
radius	.0361 m					
height	.0458 m					
weight	.3226 kg					
volume	0.0001872 m ³					
density	1723 kg/m³					
moisture	52.30%					
TH3 at 20 ft.						
radius	0.036 m					
height	0.0492 m					
weight	0.3367 kg					
volume	0.0002001 m ³					
density	1683 kg/m³					
moisture	56%					

ATTERBERG LIMITS

CLIENT: WSP Canada Inc. PROJECT NO.: 1502-7
1600 Buffalo Place
Winnipeg, MB R3T 6B8
ATTENTION: S. Urbano
PROJECT: Lorette

Liquid Limit Determination

Dish No.:	1	2	3		Liquid Limit 25 Blows
Wet Soil + Dish:	16	14.8	14.5		
Dry Soil + Dish:	12.2	11.3	11		
Moisture:	3.8	3.5	3.5		
Dish:	4.2	4.2	4.2		
Dry Soil:	8	7.1	6.8		
% Moisture:	47.50	49.30	51.47		
No. of Blows:	33	24	19		
Liquid Limits:	49.12	49.05	49.79		49.32

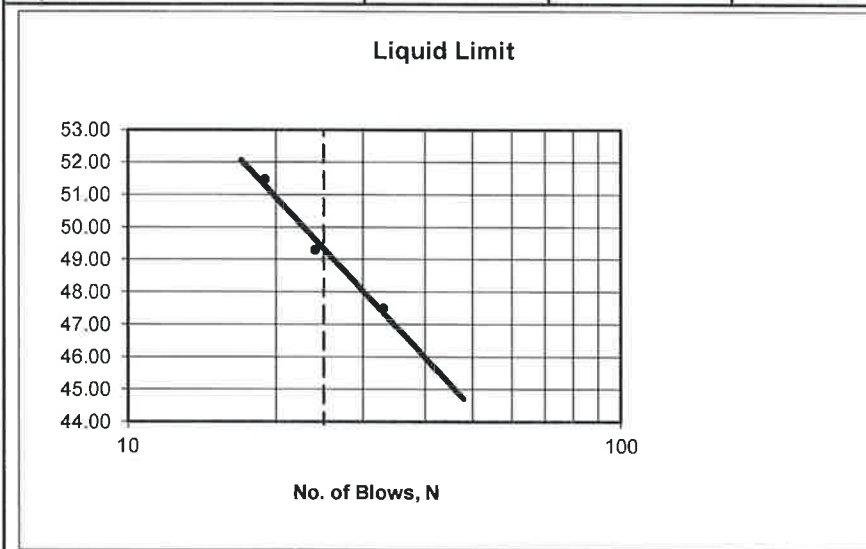

Material Identification:

T.H./B.H. No. TH3

Depth: 5 ft

Liquid Limit, %: 49

Plastic Limit, %: 21

Plasticity Index: 29

(LL-PL)

Plastic Limit Determination

Dish No.:	1	2	3		
Wet Soil + Dish:	15.1	14.4	14		
Dry Soil + Dish:	13.3	12.7	12.3		
Moisture:	1.8	1.7	1.7		
Dish:	4.4	4.4	4.2		
Dry Soil:	8.9	8.3	8.1		
% Moisture:	20.22	20.48	20.99		
Average:					20.56

Test Method : ASTM: D4318, D2216

HMCL Tech: ECS

Reviewed by: Hermie Manalo

ATTERBERG LIMITS

CLIENT: WSP Canada PROJECT NO.: 1502-7
1600 Buffalo Place
Winnipeg, MB R3T 6B8
ATTENTION: S. Urbano
PROJECT: Lorette

Liquid Limit Determination

Dish No.:	1	2	3		Liquid Limit 25 Blows
Wet Soil + Dish:	24.7	22.3	23.9		
Dry Soil + Dish:	16.1	14.5	15.4		
Moisture:	8.6	7.8	8.5		
Dish:	4.6	4.2	4.4		
Dry Soil:	11.5	10.3	11		
% Moisture:	74.78	75.73	77.27		
No. of Blows:	34	26	23		
Liquid Limits:	77.62	76.09	76.50		76.73

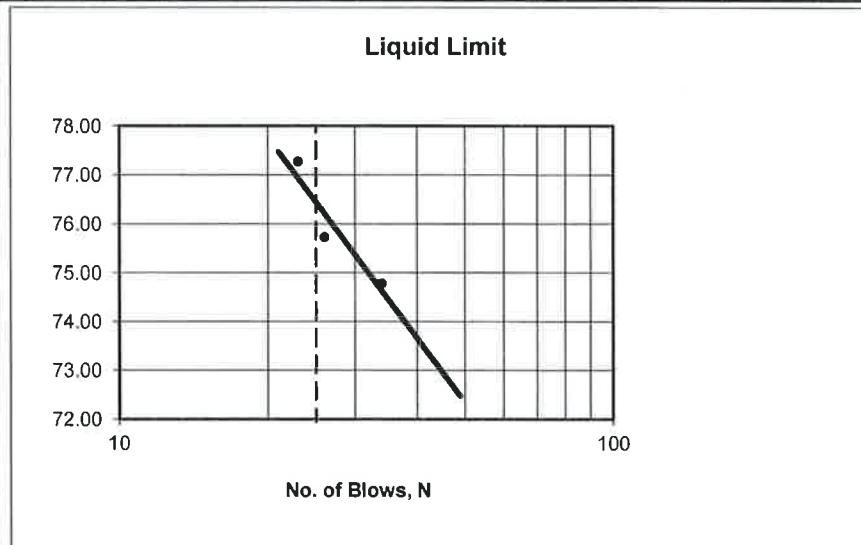

Material Identification:

T.H./B.H. No. **TH4**

Depth: **5 ft**

Liquid Limit, %: 77
Plastic Limit, %: 25
Plasticity Index: 51
(LL-PL)

Plastic Limit Determination

Dish No.:	1	2	3		
Wet Soil + Dish:	12	10.3	11.6		
Dry Soil + Dish:	10.5	9.1	10		
Moisture:	1.5	1.2	1.6		
Dish:	4.2	4.3	4.2		
Dry Soil:	6.3	4.8	5.8		
% Moisture:	23.81	25.00	27.59		
Average:					25.47

Test Method : ASTM: D4318, D2216
HMCL Tech: ECS

Reviewed by: Hermie Manalo

ATTERBERG LIMITS

CLIENT: WSP Canada Inc. PROJECT NO.: 1502-7
1600 Buffalo Place
Winnipeg, MB R3T 6B8
ATTENTION: S. Urbano
PROJECT: Lorette

Liquid Limit Determination

Dish No.:	1	2	3		Liquid Limit 25 Blows
Wet Soil + Dish:	14.2	15.6	14.1		
Dry Soil + Dish:	9.6	10.3	9.4		
Moisture:	4.6	5.3	4.7		
Dish:	4.2	4.3	4.2		
Dry Soil:	5.4	6	5.2		
% Moisture:	85.19	88.33	90.38		
No. of Blows:	34	25	19		
Liquid Limits:	88.41	88.33	87.43		

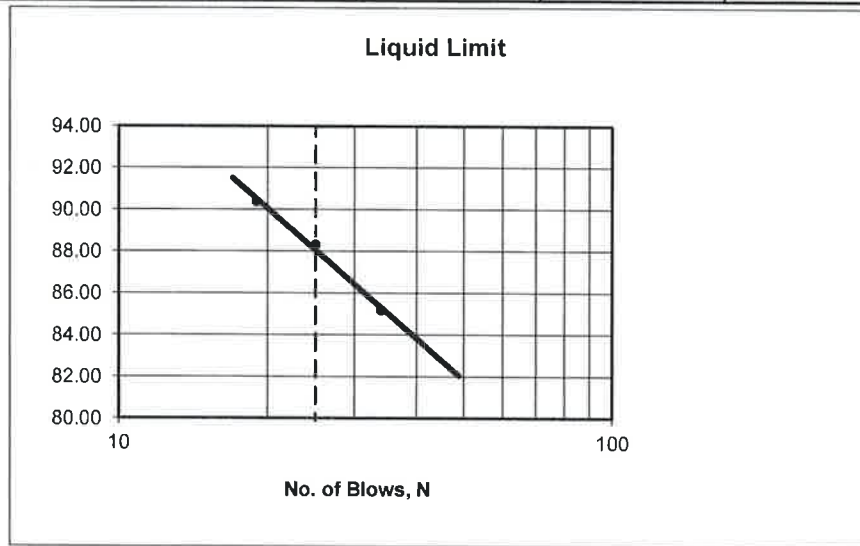

Material Identification:

T.H./B.H. No. TH8

Depth: 2.5 ft

Liquid Limit, %: 88

Plastic Limit, %: 37

Plasticity Index: 51

(LL-PL)

Plastic Limit Determination

Dish No.:	1	2	3			
Wet Soil + Dish:	12.8	11.7	13.8			
Dry Soil + Dish:	10.5	9.7	11.2			
Moisture:	2.3	2	2.6			
Dish:	4.2	4.2	4.2			
Dry Soil:	6.3	5.5	7			
% Moisture:	36.51	36.36	37.14			
Average:						36.67

Test Method : ASTM: D4318, D2216
HMCL Tech: ECS

Reviewed by: Hermie Manalo



Project No. 1000 012 06
Client H Manalo Consulting Ltd.
Project Lorette

Test Hole N/A
Trek Sample # L160A
Depth (m) N/A
Sample Date N/A
Test Date Apr 28, 2015 to May 28, 2015
Technician Paul Bevel

Specimen Details

Visual Clay, silty, mottled grey and brown, firm, moist

Classification

Comments The specific gravity of the soil was assumed to be 2.70.

Atterberg Limits

Liquid Limit Not Requested
Plastic Limit Not Requested
Plasticity Index Not Requested

Test Details

Permeant Distilled, de-aired water
Method Constant Head
Cell Pressure 248.2 kPa
Influent Pressure 210.3 kPa
Effluent Pressure 193.1 kPa
Gradient 19.99

Permeation Graph

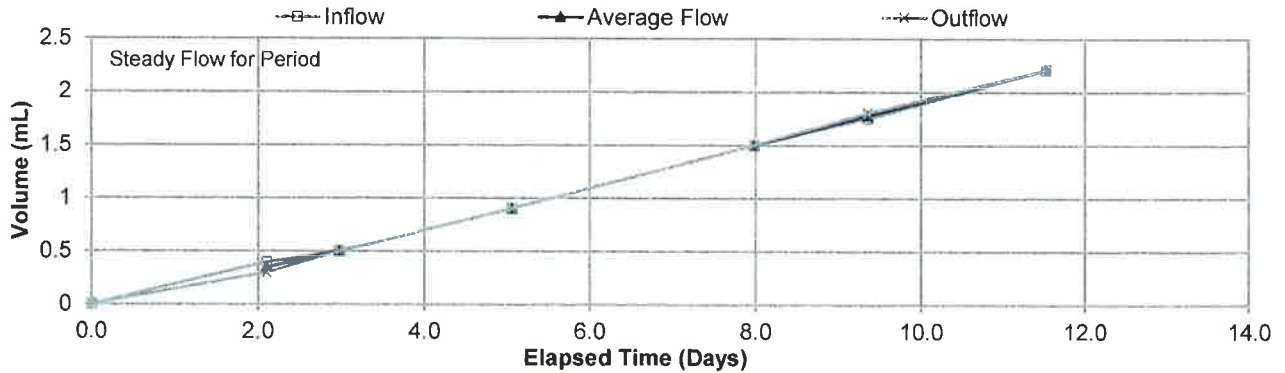

Steady Flow Permeation Data

Time Increment (Days)	Elapsed Time (Days)	Flow (Q)		Inflow / Outflow Ratio	Average Flow (mL)	Temperature Correction	Corrected Hydraulic Conductivity, k_{20} (m/s)
		Influent (mL)	Effluent (mL)				
2.08	5.06	0.40	0.40	1.00	0.40	0.95	2.57E-11
2.92	7.98	0.60	0.60	1.00	0.60	0.93	2.69E-11
1.38	9.35	0.25	0.30	0.83	0.28	0.91	2.55E-11
2.17	11.52	0.45	0.40	1.13	0.43	1.00	2.75E-11

Average Temperature Corrected Hydraulic Conductivity, k_{20} (m/s) **2.64E-11 (2.64x10⁻⁹ cm/s)**

Consolidation Data

	Average Height (m)	Average Diameter (m)	Moisture Content (%)	Dry Density (kN/m ³)	Degree of Saturation (%)	Cell Pressure	Back Pressure
Initial	0.088	0.072	47.2	11.6	98.9	206.8	144.8
Final	0.088	0.072	49.6	11.5	103.4	206.8	144.8

Appendix D

PLANS AND DETAILS

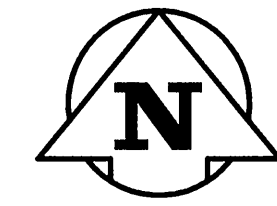

CONSULTANT:

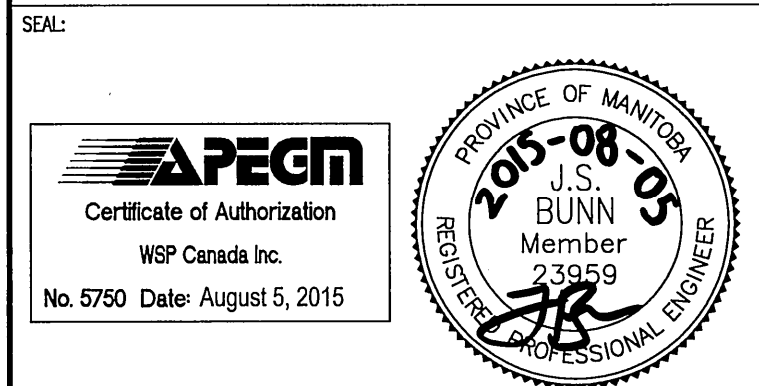

CLIENT:

R.M. OF TACHE

CLIENT REF. #:
PROJECT:

COMMUNITY OF LORETTE
 WASTEWATER TREATMENT
 LAGOON EXPANSION

KEY PLAN:

DISCLAIMER: THIS DRAWING AND DESIGN IS COPYRIGHT PROTECTED WHICH SHALL NOT BE USED, REPRODUCED OR REVISED WITHOUT WRITTEN PERMISSION BY WSP. THE CONTRACTOR SHALL CHECK AND VERIFY ALL DIMENSIONS AND UTILITY LOCATIONS AND REPORT ALL ERRORS AND OMISSIONS PRIOR TO COMMENCING WORK. THIS DRAWING IS NOT TO BE SCALED.

ISSUED FOR - REVISION:

IS	RE	DATE	DESCRIPTION
1		2015/08/05	EAP SUBMISSION

PROJECT NO: 151-01867-00 DATE: 2015/08/05

ORIGINAL SCALE: 1:2000 IF THIS BAR IS NOT 25mm LONG, ADJUST YOUR PLOTTING SCALE.

DESIGNED BY: JSB
 DRAWN BY: JSB
 CHECKED BY: RWV

DISCIPLINE: ENVIRONMENTAL INFRASTRUCTURE

TITLE: EXISTING SITE PLAN

SHEET NUMBER: C01

SHEET # 1 of 3

ISSUE: EAP SUBMISSION
 DATE OF: 2015/08/05

GEOTECHNICAL INVESTIGATION (2015)

TESTHOLE ID	APPROX. DEPTH TO SUITABLE CLAY (m)	TOPSOIL DEPTH (mm)
1	0.3	125
2	0.3	200
3	1.5	100
4	0.3	150
5	1.8	125
6	0.3	150
7	1.8	200
8	0.3	150
9	3.4	200
10	0.3	150
11	0.3	150

- EXISTING GRAVELED AREA
- EXISTING CLAY CORE

NOTES:

- LOCATION OF UNDERGROUND STRUCTURES AS SHOWN IS BASED ON THE BEST INFORMATION AVAILABLE. BUT NO GUARANTEE IS GIVEN THAT ALL EXISTING UTILITIES ARE SHOWN OR THAT THE GIVEN LOCATIONS ARE EXACT. CONFIRMATION OF EXISTENCE AND EXACT LOCATION OF ALL SERVICES MUST BE OBTAINED FROM THE INDIVIDUAL UTILITIES BEFORE PROCEEDING WITH CONSTRUCTION. THE CONTRACTOR SHALL NOTIFY THE CONSULTANT OF ANY ERROR OR OMISSION IN THE LOCATION OF ALL EXISTING UTILITIES SHOWN ON THE DRAWING.
- DESCRIPTION OF PROPERTY LIMITS, AND EXISTING AND/OR PROPOSED FEATURES RELATIVE TO THESE LIMITS AS SHOWN ON THIS DRAWING DO NOT REPRESENT A LEGAL SURVEY. WSP MAKES NO REPRESENTATION OR GUARANTEE THAT THE PROPERTY LIMIT INFORMATION IS ACCURATE. WSP ACCEPTS NO RESPONSIBILITY FOR DAMAGES, IF ANY, SUFFERED BY ANY THIRD PARTY AS A RESULT OF DECISIONS OR ACTIONS BASED ON THIS DRAWING.
- WHOLE NUMBERS INDICATE MILLIMETRES; DECIMALIZED NUMBERS INDICATE METRES
- EXISTING DYKE RIP RAP NOT SHOWN FOR CLARITY.

SYMBOL	DESCRIPTION	SYMBOL	DESCRIPTION
---	WATERMAIN	---	WWS
---	WASTEWATER	---	LPS
---	LOW PRESSURE SEWER	---	LPS
---	FORCEMAIN	---	FM
○	GATE VALVE	○	MANHOLE
○	HYDRANT	●	HYDRANT
○	UTILITY POLE	○	GUY WIRE
□	CATCH BASIN	■	CURB INLET
□	HYDRO TOWER	▲	SIGN
+	MTS PEDESTAL	+	SURVEY BAR
+	CLEAN OUT	+	CULVERT
---	DITCH / SWALE	---	TREE OR SHRUB LINE
---	FENCE LINE	---	HYDRO
---	GAS MAIN	---	MTS
---	DIRECTION OF FLOW	---	WICK DRAIN
---	RIP RAP	---	GROUND ELEVATION
---	GROUND ELEVATION	---	DITCH ELEVATION
---	DITCH ELEVATION	---	ROAD/DYKE ELEVATION
---	ROAD/DYKE ELEVATION	---	DYKE
---	EXISTING	---	LEGEND
---	LEGEND	---	PROPOSED

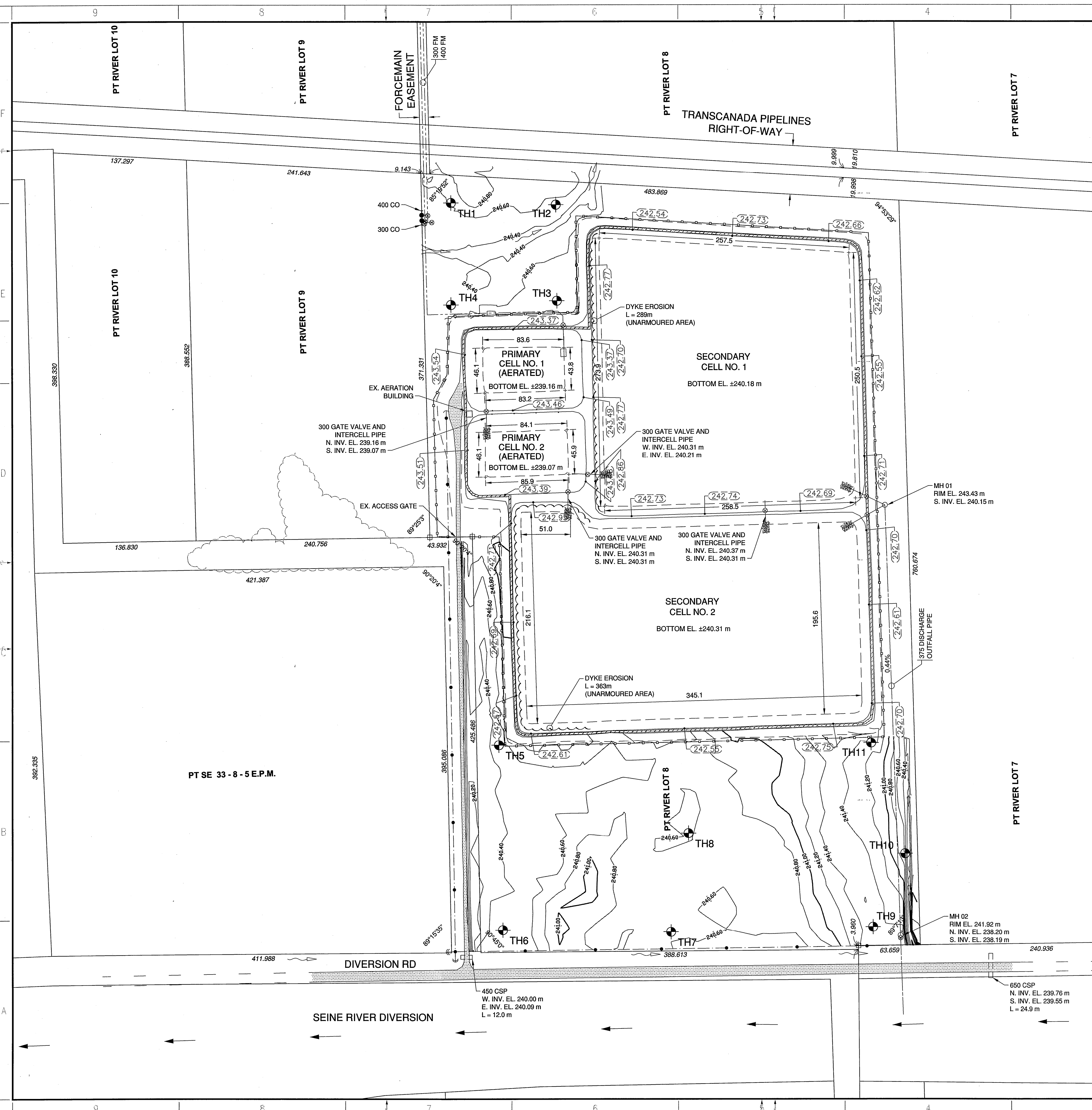

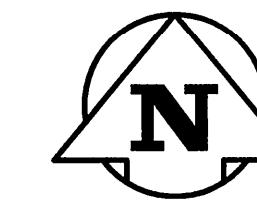

CONSULTANT:

SEAL:

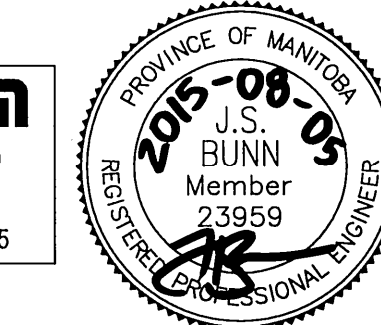
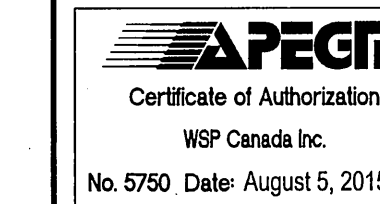

CLIENT:

R.M. OF TACHE

CLIENT REF. #:

PROJECT:

COMMUNITY OF LORETTE
WASTEWATER TREATMENT
LAGOON EXPANSION

KEY PLAN:

DISCLAIMER:

THIS DRAWING AND DESIGN IS COPYRIGHT PROTECTED WHICH SHALL NOT BE USED, REPRODUCED OR REVISED WITHOUT WRITTEN PERMISSION BY WSP. THE CONTRACTOR SHALL CHECK AND VERIFY ALL DIMENSIONS AND UTILITY LOCATIONS AND REPORT ALL ERRORS AND OMISSIONS PRIOR TO COMMENCING WORK. THIS DRAWING IS NOT TO BE SCALED.

ISSUED FOR - REVISION:

1 2015/08/05 EAP SUBMISSION

PROJECT NO: 151-01887-00 DATE: 2015/08/05

ORIGINAL SCALE: AS SHOWN IF THIS BAR IS NOT 25mm LONG, ADJUST YOUR PLOTTING SCALE.

DESIGNED BY: JSB
DRAWN BY: JSB
CHECKED BY: RWW

DISCIPLINE: ENVIRONMENTAL INFRASTRUCTURE

TITLE: EXISTING SITE PLAN

SHEET NUMBER: C02

SHEET #: 2 OF 3

ISSUE: EAP SUBMISSION
DATE OF: 2015/08/05

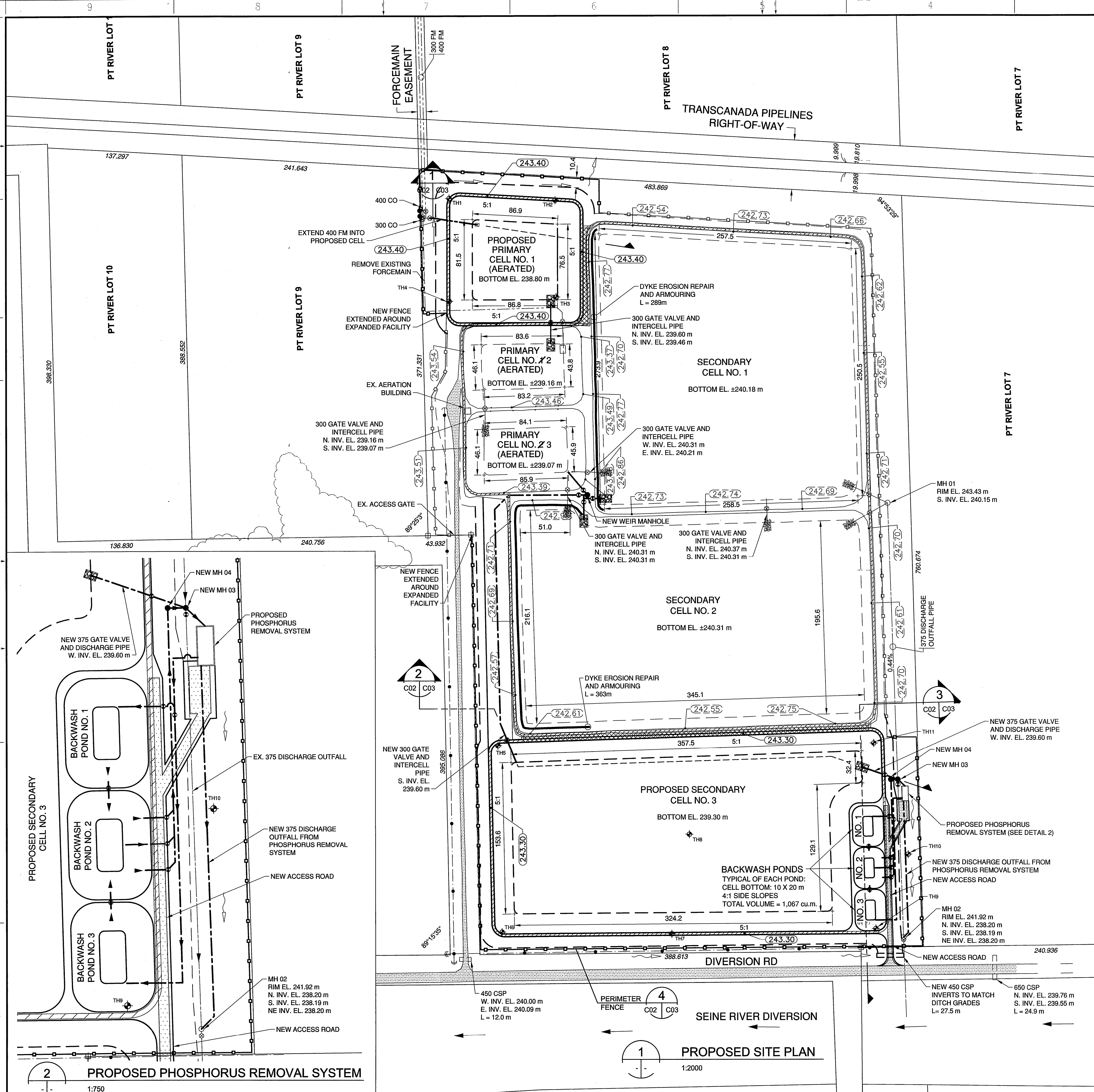

- EXISTING GRAVELED AREA
- PROPOSED GRAVELED AREA
- EXISTING CLAY CORE
- PROPOSED CLAY CORE
- LINER TIE-IN AREA

NOTES:

1. LOCATION OF UNDERGROUND STRUCTURES AS SHOWN IS BASED ON THE BEST INFORMATION AVAILABLE, BUT NO GUARANTEE IS GIVEN THAT ALL EXISTING UTILITIES ARE SHOWN OR THAT THE GIVEN LOCATIONS ARE EXACT. CONFIRMATION OF EXISTENCE AND EXACT LOCATION OF ALL SERVICES MUST BE OBTAINED FROM THE INDIVIDUAL UTILITIES BEFORE PROCEEDING WITH CONSTRUCTION. THE CONTRACTOR SHALL NOTIFY THE CONSULTANT OF ANY ERROR OR OMISSION IN THE LOCATION OF ALL EXISTING UTILITIES SHOWN ON THE DRAWING.
2. DESCRIPTION OF PROPERTY LIMITS, AND EXISTING AND/OR PROPOSED FEATURES RELATIVE TO THESE LIMITS AS SHOWN ON THIS DRAWING DO NOT REPRESENT A LEGAL SURVEY. WSP MAKES NO REPRESENTATION OR GUARANTEE THAT THE PROPERTY LIMIT INFORMATION IS ACCURATE. WSP ACCEPTS NO RESPONSIBILITY FOR DAMAGES, IF ANY, SUFFERED BY ANY THIRD PARTY AS A RESULT OF DECISIONS OR ACTIONS BASED ON THIS DRAWING.
3. WHOLE NUMBERS INDICATE MILLIMETRES; DECIMALIZED NUMBERS INDICATE METRES.
4. EXISTING DYKE RIP RAP NOT SHOWN FOR CLARITY.

EXISTING	LEGEND	PROPOSED
	WATERMAIN	
	WASTEWATER	
	LOW PRESSURE SEWER	
	FORCEMAIN	
	GATE VALVE	
	MANHOLE	
	HYDRANT	
	UTILITY POLE	
	GUY WIRE	
	CATCH BASIN	
	CURB INLET	
	HYDRO TOWER	
	SIGN	
	MTS PEDESTAL	
	SURVEY BAR	
	CLEAN OUT	
	CULVERT	
	DITCH / SWALE	
	TREE OR SHRUB LINE	
	FENCE LINE	
	HYDRO	
	GAS MAIN	
	MTS	
	DIRECTION OF FLOW	
	WICK DRAIN	
	RIP RAP	
	GROUND ELEVATION	99.000
	DITCH ELEVATION	99.000
	ROAD/DYKE ELEVATION	99.000
	DYKE	
	LEGEND	PROPOSED

CONSULTANT:

SEAL:

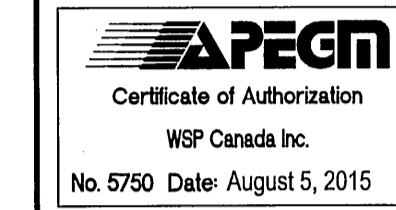

CLIENT:

R.M. OF TACHE

CLIENT REF. #:

PROJECT:

COMMUNITY OF LORETTE
WASTEWATER TREATMENT
LAGOON EXPANSION

KEY PLAN:

DISCLAIMER: THIS DRAWING AND DESIGN IS COPYRIGHT PROTECTED WHICH SHALL NOT BE USED, REPRODUCED OR REVISED WITHOUT WRITTEN PERMISSION BY WSP. THE CONTRACTOR SHALL CHECK AND VERIFY ALL DIMENSIONS AND UTILITY LOCATIONS AND REPORT ALL ERRORS AND OMISSIONS PRIOR TO COMMENCING WORK. THIS DRAWING IS NOT TO BE SCALED.

ISSUED FOR - REVISION:

IS	RE	DATE	DESCRIPTION
1		2015/08/05	EAP SUBMISSION

PROJECT NO: 151-01887-00
DATE: 2015/08/05
ORIGINAL SCALE: NTS
DESIGNED BY: JSB
DRAWN BY: JSB
CHECKED BY: RWW
DISCIPLINE: ENVIRONMENTAL INFRASTRUCTURE
TITLE: PROPOSED CELL SECTIONS, AND FENCE DETAILS
SHEET NUMBER: C03
SHEET #: 3 OF 3
ISSUE: EAP SUBMISSION
DATE OF: 2015/08/05
REV # 0

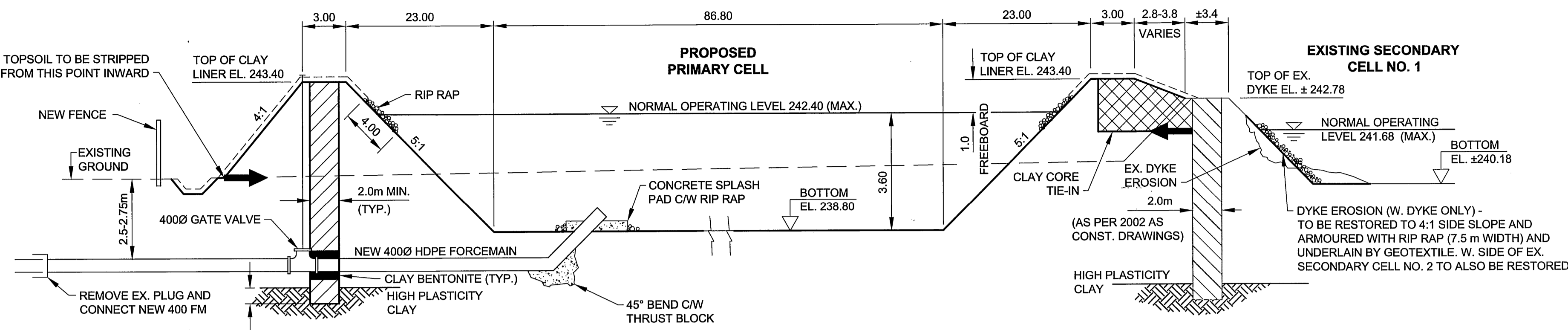

1 W/E PROPOSED PRIMARY AND EXISTING SECONDARY CELL NO. 1 SECTION
C02 C03 N.T.S.

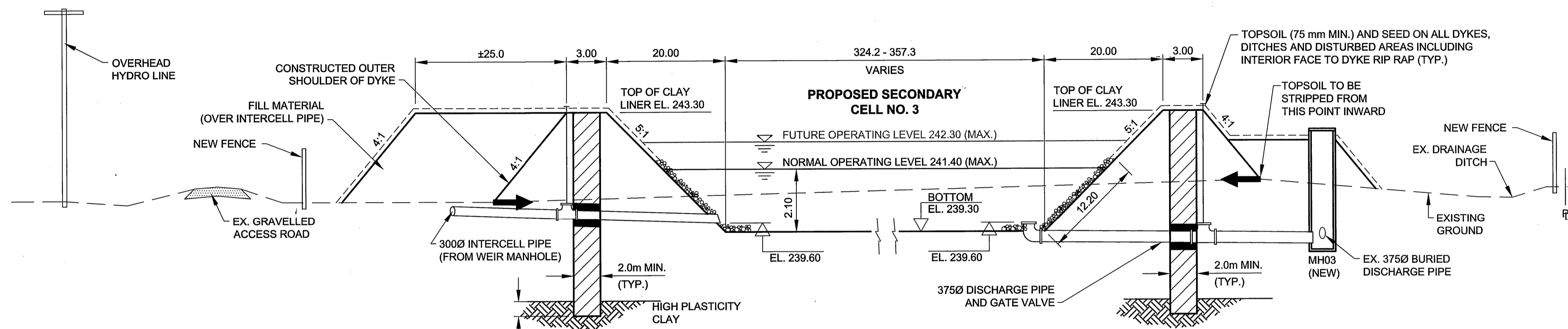

2 W/E PROPOSED SECONDARY CELL NO. 3 SECTION
C02 C03 N.T.S.

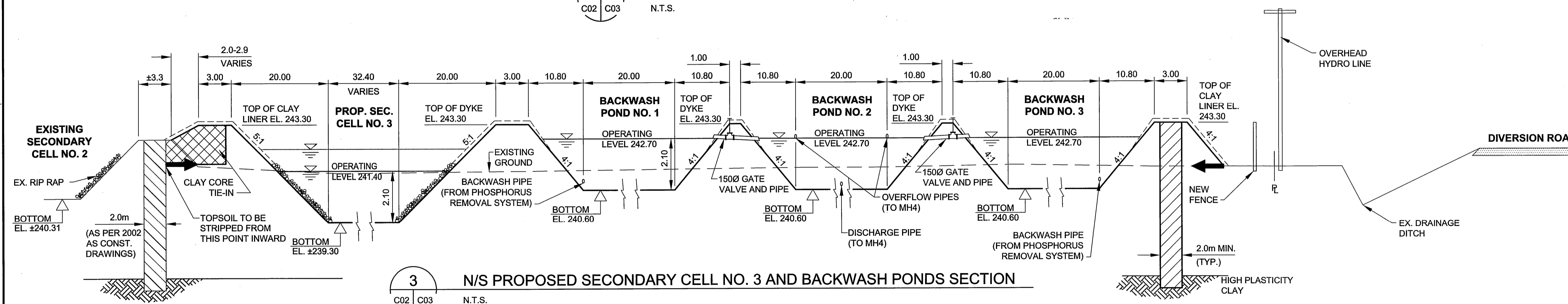

3 N/S PROPOSED SECONDARY CELL NO. 3 AND BACKWASH PONDS SECTION
C02 C03 N.T.S.

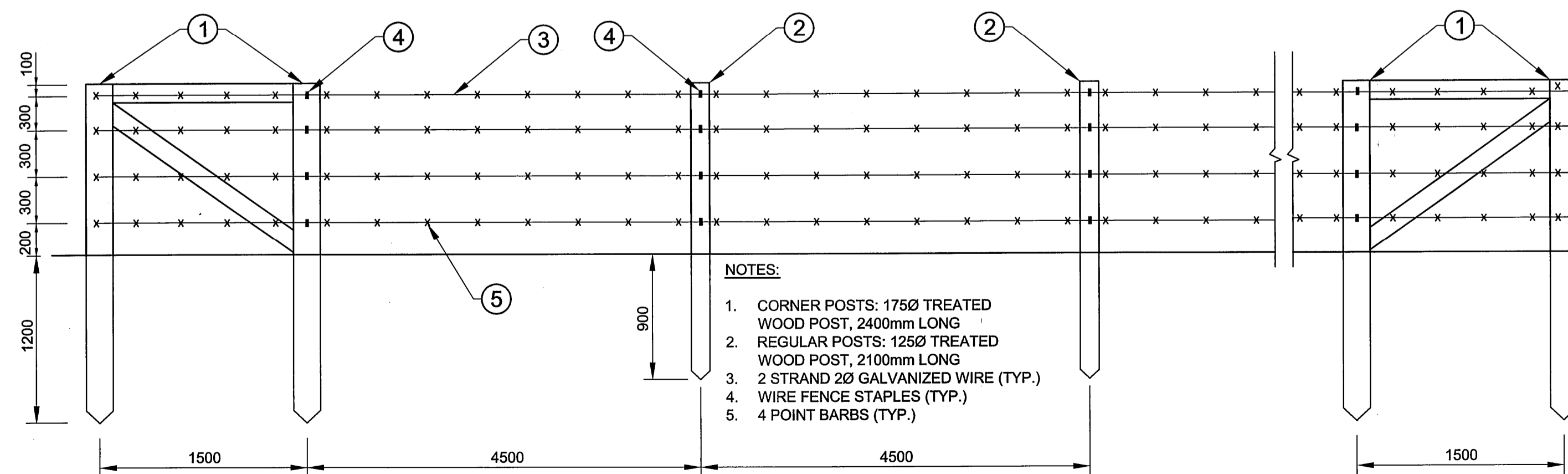

4 PERIMETER FENCE DETAIL
C02 C03 N.T.S.

NOTES:

- LOCATION OF UNDERGROUND STRUCTURES AS SHOWN IS BASED ON THE BEST INFORMATION AVAILABLE, BUT NO GUARANTEE IS GIVEN THAT ALL EXISTING UTILITIES ARE SHOWN OR THAT THE GIVEN LOCATIONS ARE EXACT. CONFIRMATION OF EXISTENCE AND EXACT LOCATION OF ALL SERVICES MUST BE OBTAINED FROM THE INDIVIDUAL UTILITIES BEFORE PROCEEDING WITH CONSTRUCTION. THE CONTRACTOR SHALL NOTIFY THE CONSULTANT OF ANY ERROR OR OMISSION IN THE LOCATION OF ALL EXISTING UTILITIES SHOWN ON THE DRAWING.
- DESCRIPTION OF PROPERTY LIMITS, AND EXISTING AND/OR PROPOSED FEATURES RELATIVE TO THESE LIMITS AS SHOWN ON THIS DRAWING DO NOT REPRESENT A LEGAL SURVEY. WSP MAKES NO REPRESENTATION OR GUARANTEE THAT THE PROPERTY LIMIT INFORMATION IS ACCURATE. WSP ACCEPTS NO RESPONSIBILITY FOR DAMAGES, IF ANY, SUFFERED BY ANY THIRD PARTY AS A RESULT OF DECISIONS OR ACTIONS BASED ON THIS DRAWING.
- WHOLE NUMBERS INDICATE MILLIMETRES; DECIMALIZED NUMBERS INDICATE METRES

PLOT SIZE: 610mm x 914mm (24" x 36")

REDUCED SIZE PLOT - DO NOT SCALE

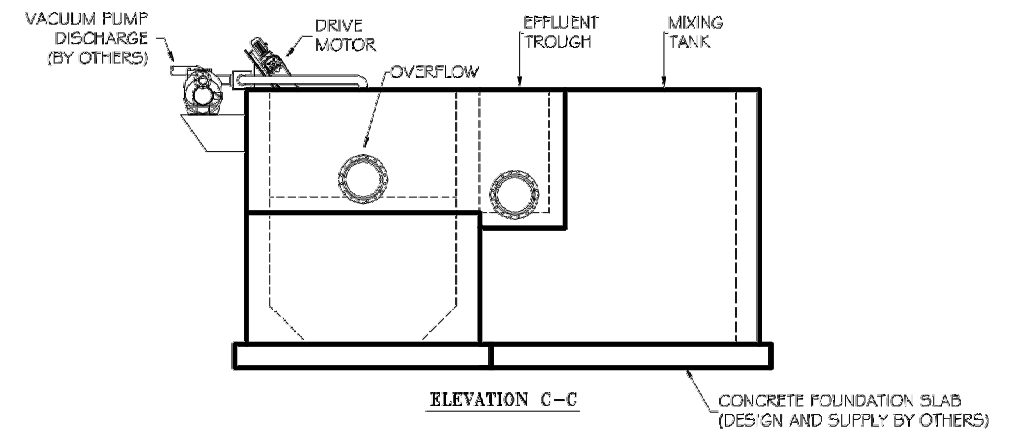
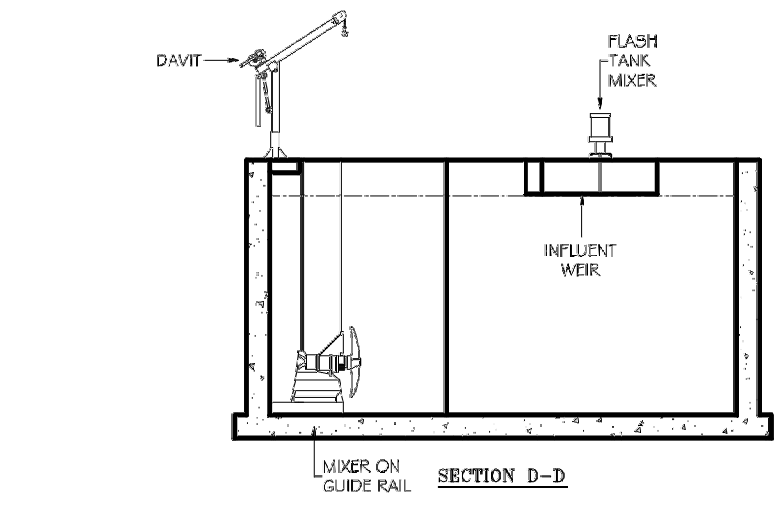
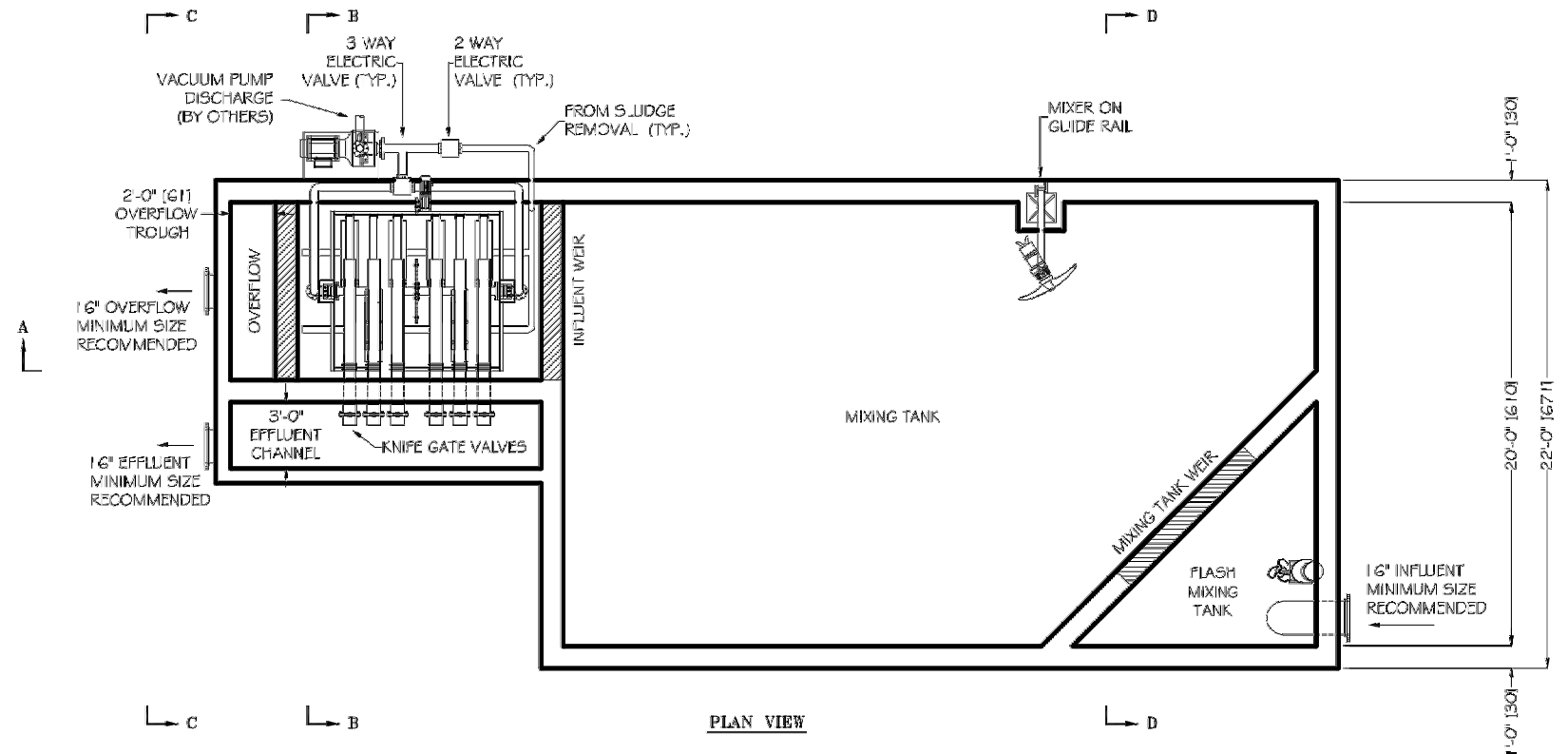

Note:
Piping sizes and trough dimensions are for information only and actual pipe sizes and trough dimensions will be provided upon receipt of accurate hydraulic profile & plant piping layout.

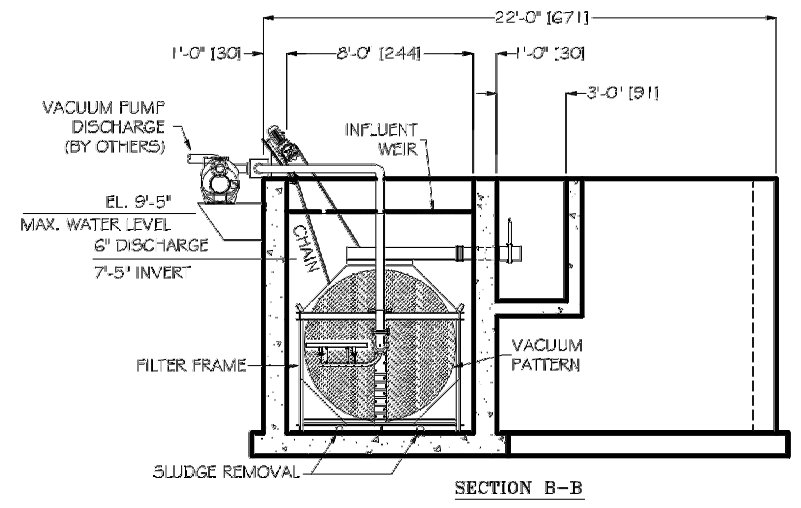
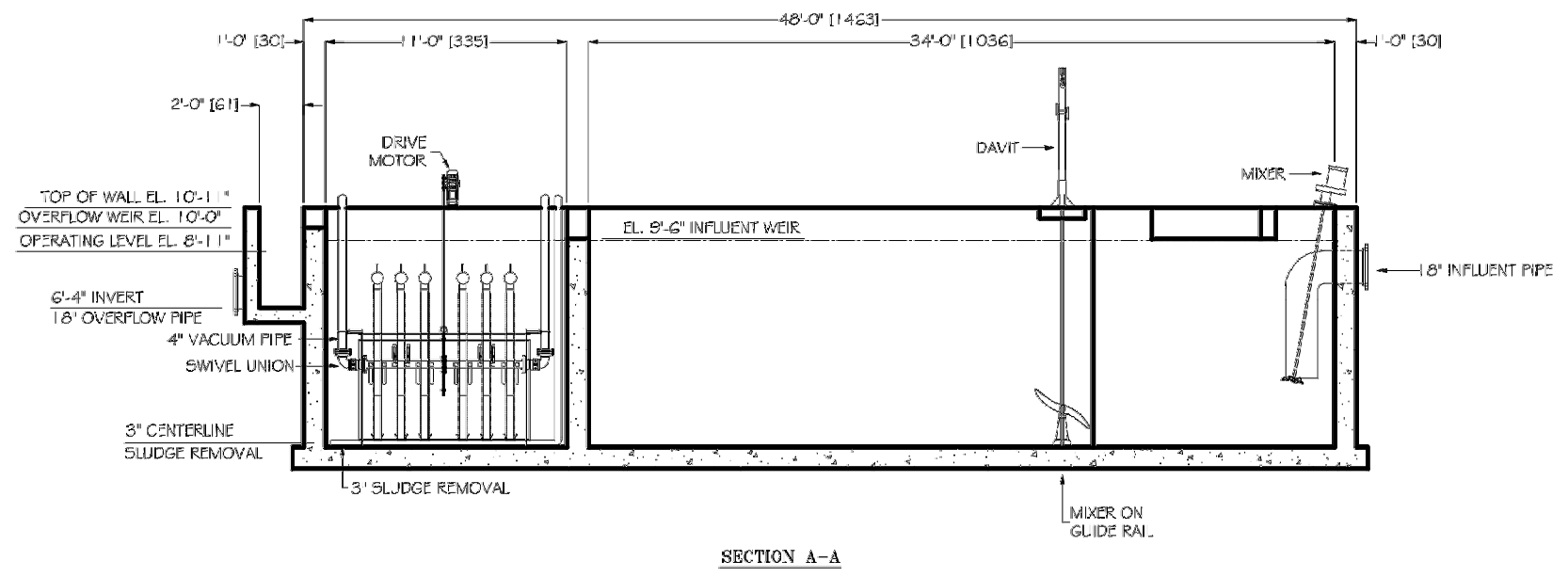

NELSON ENVIRONMENTAL INC.
5 BURKS WAY
WINNIPEG, MANITOBA
CANADA R2J 3R8
Ph: (204) 949-7500
Fax: (204) 237-0660
www.nelsonenvironmental.com

PROJECT:		LORETTE, MB	
		PROPOSED WASTEWATER TREATMENT SYSTEM	
TITLE:		OPTAER PHOSPHORUS REMOVAL SYSTEM	
		PLAN, ELEVATIONS, SECTIONS	
DRAWN BY:	APPROVED BY:	SCALE:	DRAWING NO.
JG	LE	AS NOTED	NE03
DATE:	FILE #		SHT. REV.
2014/03/25	CD2498.02		3 of 3

Appendix E

GENERAL CORRESPONDENCE FOR REFERENCE

Bunn, Jason

From: Little, Karen (CLPA) <Karen.Little@gov.mb.ca>
Sent: Tuesday, March 24, 2015 3:49 PM
To: Bunn, Jason
Subject: RE: Mineral Rights Information Request [WSP# 151-01887-00]

Good afternoon Jason ~ according to our records this date, the Dominion of Canada granted River Lot 8 Parish of Lorette in September 1884 to Phillip McGuire along with the mines & minerals and sand & gravel. The Crown kept no under-rights.

If as you say Status of Title 1712839/1 is silent - "no exceptions/ subject to" relating to mines & minerals, then the mines & minerals and sand & gravel have remained with the surface title. <Karen>

Karen Little

Supervisor of Crown Lands Registry

Crown Lands and Property Agency
308 - 25 Tupper Street North
Portage la Prairie MB R1N 3K1
P 204-239-3805 F 204-239-3560
Toll Free 1-866-210-9589
karen.little@gov.mb.ca



An Agency of the Manitoba Government

The information contained in this e-mail and all attachments is confidential and is for the sole use of its intended recipient. It may not be disclosed to or used by anyone other than the addressee. If received in error, please contact the sender by return e-mail and delete this e-mail and all attachments from your system.

Le présent courrier électronique (courriel) et les documents qui y sont attachés peuvent contenir de l'information confidentielle; ils s'adressent exclusivement au destinataire mentionné ci-dessus et nulle autre personne ne doit en prendre connaissance ni les utiliser ou les divulguer. Si vous recevez le présent courriel par erreur, veuillez en aviser l'émetteur immédiatement par courrier électronique et le détruire avec les documents qui y sont attachés.

From: Bunn, Jason [mailto:Jason.Bunn@wspgroup.com]
Sent: March-24-15 3:38 PM
To: Little, Karen (CLPA)
Cc: CA - WinnipegFiling
Subject: Mineral Rights Information Request [WSP# 151-01887-00]

Hi Karen,

I'm preparing an Environment Act Proposal for the R.M. of Taché and require the mineral rights (Mines and Minerals and Sand and Gravel) for River Lot 8, Parish of Lorette. The Status of Title (1712839/1) is silent on the Mines and Minerals. I would greatly appreciate any information you can provide before April 7.

Kind regards,



Jason Bunn, P.Eng.
Environmental Engineer

WSP Canada Inc.

1600 Buffalo Place, Winnipeg, Manitoba R3T 6B8

T 204 477 6650 ext#307 | F 204 474 2864 | E jason.bunn@wspgroup.com

www.wspgroup.com

If you wish to stop receiving electronic commercial communications from us, please send an empty email to unsubscribecanada@wspgroup.com. Please refer to our Privacy Policy at www.wspgroup.com/privacy and our Anti-Spam Commitment at www.wspgroup.com/casl

CONFIDENTIALITY WARNING

This message is intended only for the use of the individual or entity to which it is addressed, and may contain information which is privileged, confidential, proprietary or exempt from disclosure under applicable law. If you are not the intended recipient or the person responsible for delivering the message to the intended recipient, you are strictly prohibited from disclosing, distributing, copying or in any way using this message. If you have received this communication in error, please notify the sender, and destroy and delete any copies you may have received.

Si vous ne souhaitez plus recevoir de communications électroniques de nature commerciale de notre part, veuillez s'il-vous-plaît envoyer un courriel vide à desabonnementcanada@wspgroup.com. Prière de vous référer à notre politique en matière de confidentialité au www.wspgroup.com/confidentialite et à notre engagement anti-pourriel au www.wspgroup.com/lcap

AVERTISSEMENT

Ce message est destiné uniquement à la personne ou à l'organisation à laquelle il est adressé et il peut contenir des informations privilégiées, confidentielles ou non divulguables en vertu de la loi. Si vous n'êtes pas le destinataire du présent message ni la personne chargée de remettre le présent message à son destinataire, il vous est strictement interdit de le divulguer, de le distribuer, de le copier ou de l'utiliser de quelque façon que ce soit. Si vous avez reçu la présente communication par erreur, veuillez en aviser l'expéditeur et détruire ou effacer tous les exemplaires que vous avez reçus.

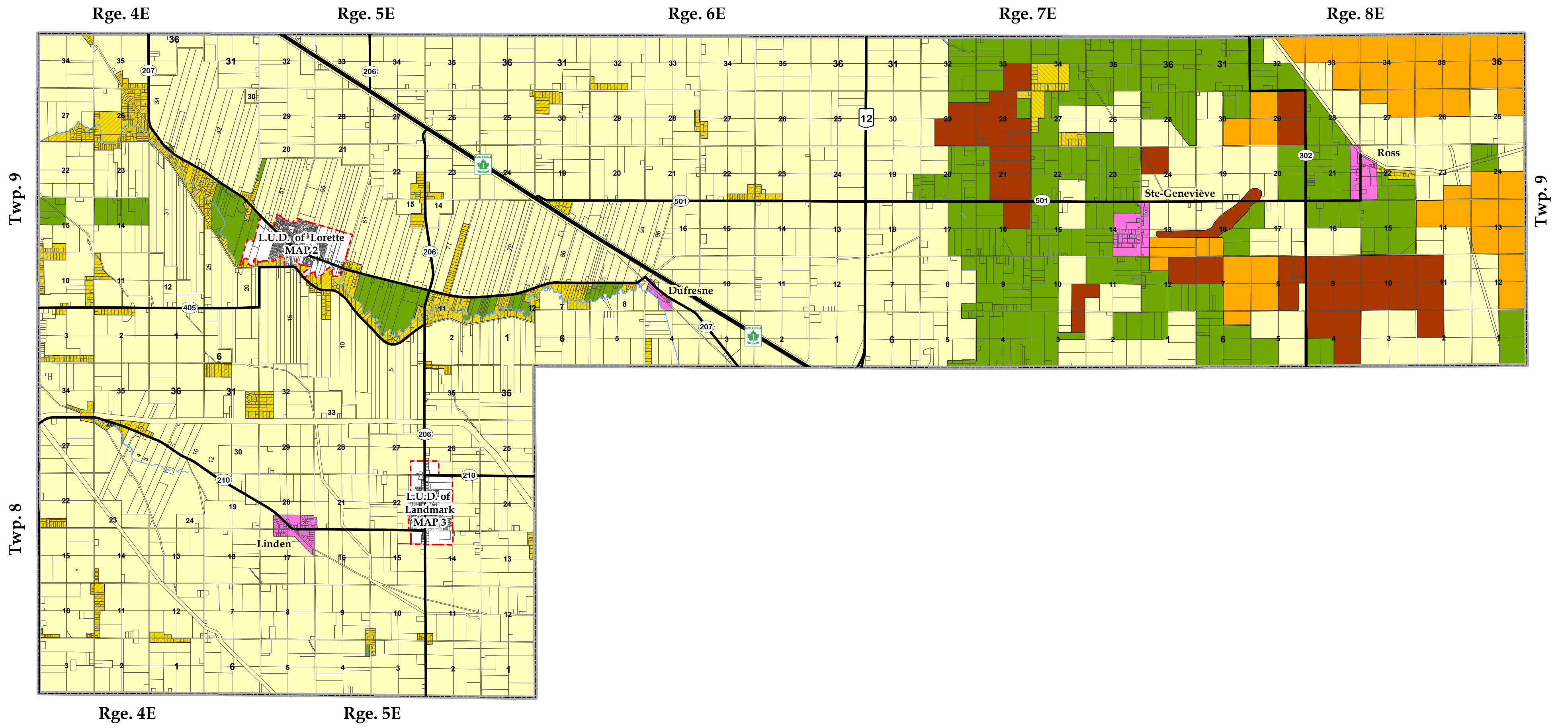

R.M. of Tache

Zoning By-Law 12-2009

MAP 1

Legend

- | | | |
|-------------------------------|-----------------------------------|--------------------|
| AG - Agriculture General Zone | RRE - Rural Residential East Zone | Municipal Boundary |
| AL - Agriculture Limited Zone | RRW - Rural Residential West Zone | L.U.D. Boundary |
| AR - Aggregate Resource Zone | SC - Settlement Centre Zone | Highways |
| NE - Natural Environment Zone | | Watercourse |

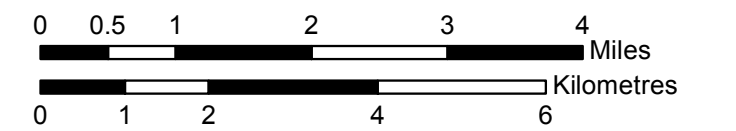

Bunn, Jason

From: McCombe, Christopher (CWS) <Christopher.McCombe@gov.mb.ca>
Sent: Tuesday, June 02, 2015 4:02 PM
To: Bunn, Jason; Matthews, Rob (CWS)
Cc: CA - WinnipegFiling
Subject: RE: Licensed Water Users Information Request [WSP# 151-01887-00]

Jason,

Based on my assessment, there are no licensed water users within ~1 km upstream and ~10 km downstream of the discharge point of the lagoon into the Seine River Diversion.

Best regards,

Christopher McCombe

Database Manager

Water Use Licensing

Manitoba Conservation and Water Stewardship

Box 16, 200 Saulteaux Crescent, Winnipeg, MB R3J 3W3

☎: 204-945-3983 📠: 204-945-7419

✉: Christopher.McCombe@gov.mb.ca

🌐: www.gov.mb.ca/conservation/waterstewardship/licensing/index.html

From: Bunn, Jason [mailto:Jason.Bunn@wspgroup.com]
Sent: June-02-15 7:18 AM
To: Matthews, Rob (CWS); McCombe, Christopher (CWS)
Cc: CA - WinnipegFiling
Subject: RE: Licensed Water Users Information Request [WSP# 151-01887-00]

Rob, please see the attached.

Kind regards,



Jason Bunn, P.Eng.
Environmental Engineer

From: Matthews, Rob (CWS) [mailto:Rob.Matthews@gov.mb.ca]
Sent: Monday, June 01, 2015 10:26 AM
To: Bunn, Jason; McCombe, Christopher (CWS)
Subject: FW: Licensed Water Users Information Request [WSP# 151-01887-00]

Jason,

Can you provide us with the attachment that you originally sent to Asit Dey?

See below.

Rob

From: Bunn, Jason [<mailto:Jason.Bunn@wspgroup.com>]
Sent: March-24-15 3:42 PM
To: Dey, Asit (CWS)
Cc: CA - WinnipegFiling
Subject: Licensed Water Users Information Request [WSP# 151-01887-00]

Hello Asit,

I'm preparing an Environment Act Proposal for the R.M. of Taché regarding the expansion of their existing lagoon located in River Lot 8, Parish of Lorette (see attachment). The lagoon discharges by piped flow into the Seine River Diversion ([see attached](#)). Please provide the licensed water users within ~1 km upstream and ~10 km downstream of the discharge point into the Seine River Diversion.

Kind regards,



Jason Bunn, P.Eng.
Environmental Engineer

WSP Canada Inc.
1600 Buffalo Place, Winnipeg, Manitoba R3T 6B8
T 204 477 6650 ext#307 | F 204 474 2864 | E jason.bunn@wspgroup.com
www.wspgroup.com

If you wish to stop receiving electronic commercial communications from us, please send an empty email to unsubscribecanada@wspgroup.com. Please refer to our Privacy Policy at www.wspgroup.com/privacy and our Anti-Spam Commitment at www.wspgroup.com/casl

CONFIDENTIALITY WARNING

This message is intended only for the use of the individual or entity to which it is addressed, and may contain information which is privileged, confidential, proprietary or exempt from disclosure under applicable law. If you are not the intended recipient or the person responsible for delivering the message to the intended recipient, you are strictly prohibited from disclosing, distributing, copying or in any way using this message. If you have received this communication in error, please notify the sender, and destroy and delete any copies you may have received.

Si vous ne souhaitez plus recevoir de communications électroniques de nature commerciale de notre part, veuillez s'il-vous-plaît envoyer un courriel vide à desabonnementcanada@wspgroup.com. Prière de vous référer à notre politique en matière de confidentialité au www.wspgroup.com/confidentialite et à notre engagement anti-pourriel au www.wspgroup.com/lcap

AVERTISSEMENT

Ce message est destiné uniquement à la personne ou à l'organisation à laquelle il est adressé et il peut contenir des informations privilégiées, confidentielles ou non divulguables en vertu de la loi. Si vous n'êtes pas le destinataire du présent message ni la personne chargée de remettre le présent message à son destinataire, il vous est strictement interdit de le divulguer, de le distribuer, de le copier ou de l'utiliser de quelque façon que ce soit. Si vous avez reçu la présente communication par erreur, veuillez en aviser l'expéditeur et détruire ou effacer tous les exemplaires que vous avez reçus.

You are receiving this communication because you are listed as a current WSP contact. Should you have any questions regarding WSP's electronic communications policy, please consult our Anti-Spam Commitment www.wspgroup.com/casl or contact us at caslcompliance@wspgroup.com.

CONFIDENTIALITY WARNING

This message is intended only for the use of the individual or entity to which it is addressed, and may contain information which is privileged, confidential, proprietary or exempt from disclosure under applicable law. If you are not the intended recipient or the person responsible for delivering the message to the intended recipient, you are strictly prohibited from disclosing, distributing, copying or in any way using this message. If you have received this communication in error, please notify the sender, and destroy and delete any copies you may have received.

Vous recevez cette communication car vous faites partis des contacts de WSP. Si vous avez des questions concernant la politique de communications électroniques de WSP, veuillez consulter notre Engagement anti-pourriel www.wspgroup.com/lcap ou contactez-nous au conformitelcap@wspgroup.com.

AVERTISSEMENT

Ce message est destiné uniquement à la personne ou à l'organisation à laquelle il est adressé et il peut contenir des informations privilégiées, confidentielles ou non divulguables en vertu de la loi. Si vous n'êtes pas le destinataire du présent message ni la personne chargée de remettre le présent message à son

destinataire, il vous est strictement interdit de le divulguer, de le distribuer, de le copier ou de l'utiliser de quelque façon que ce soit. Si vous avez reçu la présente communication par erreur, veuillez en aviser l'expéditeur et détruire ou effacer tous les exemplaires que vous avez reçus.

Bunn, Jason

From: Friesen, Chris (CWS) <Chris.Friesen@gov.mb.ca>
Sent: Thursday, April 02, 2015 9:56 AM
To: Bunn, Jason
Cc: CA - WinnipegFiling
Subject: RE: Rare Species Request - River Lot 8, Parish of Lorette [WSP# 151-01887-00]

Jason

Thank you for your information request. I completed a search of the Manitoba Conservation Data Centre's rare species database and found no occurrences at this time for your area of interest.

The information provided in this letter is based on existing data known to the Manitoba Conservation Data Centre at the time of the request. These data are dependent on the research and observations of CDC staff and others who have shared their data, and reflect our current state of knowledge. **An absence of data in any particular geographic area does not necessarily mean that species or ecological communities of concern are not present;** in many areas, comprehensive surveys have never been completed. Therefore, this information should be regarded neither as a final statement on the occurrence of any species of concern, nor as a substitute for on-site surveys for species as part of environmental assessments.

Because the Manitoba CDC's Biotics database is continually updated and because information requests are evaluated by type of action, any given response is only appropriate for its respective request. Please contact the Manitoba CDC for an update on this natural heritage information if more than six months pass before it is utilized.

Third party requests for products wholly or partially derived from Biotics must be approved by the Manitoba CDC before information is released. Once approved, the primary user will identify the Manitoba CDC as data contributors on any map or publication using Biotics data, as follows as: Data developed by the Manitoba Conservation Data Centre; Wildlife Branch, Manitoba Conservation and Water Stewardship.

This letter is for information purposes only - it does not constitute consent or approval of the proposed project or activity, nor does it negate the need for any permits or approvals required by the Province of Manitoba.

We would be interested in receiving a copy of the results of any field surveys that you may undertake, to update our database with the most current knowledge of the area.

If you have any questions or require further information please contact me directly at (204) 945-7747.

Chris Friesen
Coordinator
Manitoba Conservation Data Centre
204-945-7747
chris.friesen@gov.mb.ca
<http://www.gov.mb.ca/conservation/cdc/>

From: Bunn, Jason [mailto:Jason.Bunn@wspgroup.com]
Sent: March-24-15 3:39 PM
To: Friesen, Chris (CWS)
Cc: CA - WinnipegFiling
Subject: Rare Species Request - River Lot 8, Parish of Lorette [WSP# 151-01887-00]

Hi Chris,

I'm preparing an Environment Act Proposal for the R.M. of Taché regarding a lagoon expansion. The lagoon and expansion are located within River Lot 8, Parish of Lorette. Please provide a listing of rare species for the identified area. It would be great if I received your information before April 7.

Kind regards,



Jason Bunn, P.Eng.
Environmental Engineer

WSP Canada Inc.
1600 Buffalo Place, Winnipeg, Manitoba R3T 6B8
T 204 477 6650 ext#307 | F 204 474 2864 | E jason.bunn@wspgroup.com
www.wspgroup.com

If you wish to stop receiving electronic commercial communications from us, please send an empty email to unsubscribecanada@wspgroup.com. Please refer to our Privacy Policy at www.wspgroup.com/privacy and our Anti-Spam Commitment at www.wspgroup.com/cas/

CONFIDENTIALITY WARNING

This message is intended only for the use of the individual or entity to which it is addressed, and may contain information which is privileged, confidential, proprietary or exempt from disclosure under applicable law. If you are not the intended recipient or the person responsible for delivering the message to the intended recipient, you are strictly prohibited from disclosing, distributing, copying or in any way using this message. If you have received this communication in error, please notify the sender, and destroy and delete any copies you may have received.

Si vous ne souhaitez plus recevoir de communications électroniques de nature commerciale de notre part, veuillez s'il-vous-plaît envoyer un courriel vide à desabonnementcanada@wspgroup.com. Prière de vous référer à notre politique en matière de confidentialité au www.wspgroup.com/confidentialite et à notre engagement anti-pourriel au www.wspgroup.com/lcap

AVERTISSEMENT

Ce message est destiné uniquement à la personne ou à l'organisation à laquelle il est adressé et il peut contenir des informations privilégiées, confidentielles ou non divulguables en vertu de la loi. Si vous n'êtes pas le destinataire du présent message ni la personne chargée de remettre le présent message à son destinataire, il vous est strictement interdit de le divulguer, de le distribuer, de le copier ou de l'utiliser de quelque façon que ce soit. Si vous avez reçu la présente communication par erreur, veuillez en aviser l'expéditeur et détruire ou effacer tous les exemplaires que vous avez reçus.

DATE: April 14, 2015

TO: Jason Bunn
Environmental Engineer
WSP Canada Inc.
1600 Buffalo Place
Winnipeg, Manitoba
R3T 6B8
jason.bunn@wspgroup.com

FROM: Christina Nesbitt
Impact Assessment
Archaeologist
Historic Resources Branch
Main Floor 213 Notre Dame
Avenue
Winnipeg MB
R3B 1N3
Christina.Nesbitt@gov.mb.ca
PHONE NO: (204) 945-8145

SUBJECT: Lagoon Expansion
RM of Taché
Lot 8, Parish of Lorette
HRB Screening Results

HRB FILE: AAS-14-9083

Further to your memo requesting a heritage screening for the above lagoon expansion at Lot 8 in the Parish of Lorette (Planned Area), the Historic Resources Branch (HRB) has examined the applicable areas proposed for development in conjunction with the Branch's records for areas of potential concern, and can advise you that there are no previously recorded heritage site(s) located in the Planned Area and therefore HRB has no concerns with the project at this time.

However, please be advised that if any heritage resources are encountered in association with the Planned Area during development, the Developer is required to notify HRB and HRB may require that a heritage resource management strategy be implemented to mitigate the effects of development on the heritage resources.

If you have any questions or comments, please feel free to contact the undersigned at the above noted address, phone number, or e-mail.

Christina Nesbitt