

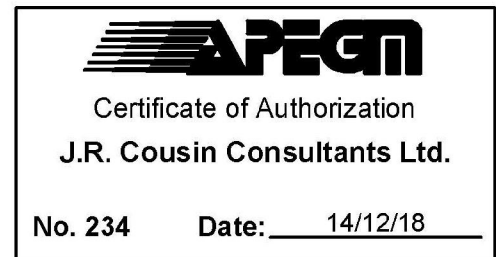

# RURAL MUNICIPALITY OF LA BROQUERIE Environment Act Proposal for the Proposed Wastewater Treatment Lagoon Expansion

Prepared by:

Brett McCormac, E.I.T.  
Environmental Engineer-in-Training



Reviewed by:

Jerry Cousin, P. Eng.  
President

December 2014



## **ACKNOWLEDGMENTS**

To prepare this report various sources of information were investigated and researched. JR Cousin Consultants Ltd. (JRCC) wishes to thank the RM of La Broquerie who contributed to the data and content of this report.

## **REMARKS**

JR Cousin Consultants Ltd. has conducted this environment act proposal in accordance with generally accepted professional engineering principles and practices for the purpose of identifying conditions that may have an environmental impact on the site. The findings and recommendations reached in this report are based on information made available to JRCC during the investigation and conditions at the time of the site investigation. Conclusions derived in this report are intended to reduce, but not wholly eliminate the uncertainty regarding potential environmental concerns on the site, and recognizes reasonable limitations with regards to time, accuracy, work scope and cost. It is possible that environmental conditions may change from the date of this report. If conditions appear different from those encountered and expressed in this report, JRCC should be informed so that mitigation recommendations can be reviewed and adjusted as required. Historical data and information obtained from personal communication used in this report, are assumed to be correct, however JRCC has not conducted further investigations into the accuracy of this data. JRCC has produced this report for the use of the client, and takes no responsibility for any third party decisions or actions based on information contained in this report.

# TABLE OF CONTENTS

Section	Page of Section
<b>ENVIRONMENTAL ACT PROPOSAL FORM</b> .....	<b>i</b>
<b>1.0 INTRODUCTION AND BACKGROUND</b> .....	<b>1</b>
1.1 Introduction .....	1
1.2 Contact Information .....	1
1.3 Background Information .....	1
1.4 Description of Previous Studies .....	2
<b>2.0 DESCRIPTION OF THE DEVELOPMENT</b> .....	<b>1</b>
2.1 Land Title/Location .....	1
2.2 Owner of Land and Mineral Rights .....	1
2.3 Existing Land Use .....	1
2.4 Land Use Designation/Zoning Designation .....	2
2.4.1 Land Classification .....	2
2.5 Description of Development .....	2
2.5.1 Project Schedule .....	2
2.5.2 Basis for Proposed Lagoon Expansion Site Selection .....	3
2.5.3 Lagoon Drainage Route .....	4
2.5.3.1 Flow in the Seine River .....	4
2.5.3.2 Seine River Fish Species .....	4
2.5.3.3 Seine River Water Quality .....	5
<b>3.0 LAGOON SIZING</b> .....	<b>1</b>
3.1 Population .....	1
3.2 Hydraulic Loading Rate .....	1
3.2.1 Community of La Broquerie .....	1
3.2.2 Rural Residents in the RM .....	3
3.2.3 Additional Sources .....	3
3.2.4 Summary of Hydraulic Loading .....	4
3.3 Organic Loading Rate .....	4
<b>4.0 LAGOON STORAGE CAPACITY</b> .....	<b>1</b>
4.1 Lagoon Storage Period .....	1
4.2 Storage Cells .....	1
<b>5.0 LAGOON SEWAGE TREATMENT</b> .....	<b>1</b>
5.1 Lagoon Treatment Requirements .....	1
5.2 Lagoon Treatment Equipment .....	1
<b>6.0 GEOTECHNICAL AND TOPOGRAPHY REVIEW</b> .....	<b>1</b>
6.1 Geotechnical Investigations .....	1
6.2 Topography .....	1
<b>7.0 LAGOON OPERATION, MAINTENANCE AND DECOMMISSIONING</b> .....	<b>1</b>
7.1 Operation and Maintenance .....	1
7.2 Sludge Management .....	1
7.2.1 Aerated Primary Cells .....	1
7.2.2 Existing Primary Cells .....	2
7.3 Lagoon Decommissioning .....	2

<b>Section</b>	<b>Page of Section</b>
<b>8.0 POTENTIAL ENVIRONMENTAL IMPACTS.....</b>	<b>1</b>
8.1 Releases to Air, Water, Land .....	1
8.1.1 Air.....	1
8.1.2 Water.....	1
8.1.3 Land .....	2
8.2 Wildlife .....	2
8.3 Fisheries.....	2
8.4 Forestry.....	3
8.5 Vegetation.....	3
8.6 Noise Impacts .....	3
8.7 Health and Safety .....	3
8.8 Heritage Resources.....	3
8.9 Socio-Economic Implications .....	4
8.10 Aesthetics .....	4
<b>9.0 MANAGEMENT PRACTICE .....</b>	<b>1</b>
9.1 Mitigation of Impacts to Air .....	1
9.2 Mitigation of Impacts to Water .....	1
9.2.1 Surface Water .....	1
9.2.2 Groundwater .....	2
9.3 Mitigation of Impacts to Land.....	3
9.4 Mitigation of Noise Impacts .....	3
9.5 Mitigation of Impacts to Health and Safety.....	3
9.6 Mitigation of Impacts to Heritage Resources .....	3
<b>10.0 RESIDUAL AND CUMULATIVE EFFECTS.....</b>	<b>1</b>
<b>11.0 MONITORING AND FOLLOW-UP .....</b>	<b>1</b>
<b>12.0 FUNDING AND APPROVALS .....</b>	<b>1</b>
<b>13.0 PUBLIC CONSULTATION.....</b>	<b>1</b>
<b>14.0 CONCLUSION.....</b>	<b>1</b>

#### Appendix A

Table 1: Population, Hydraulic, and Organic Loading Projections for the RM of La Broquerie Lagoon  
RM of La Broquerie, Land Titles and Zone Designation, November 19, 2014  
Crown Lands & Property Agency, November 06, 2014 Email Correspondence

#### Appendix B

Manitoba Conservation and Water Stewardship, 7Q10 Flows Seine River. Email Correspondence May 28, 2014  
Manitoba Conservation and Water Stewardship, Fisheries Branch. Email Correspondence December 8, 2014  
Manitoba Conservation Data Centre, Species at Risk. Email Correspondence November 18, 2014  
Manitoba Historic Resources Branch. Email Correspondence November 27, 2014

## Appendix C

Title Plan

- Plan 1: Test Hole Locations and Contour Lines
- Plan 2: Proposed Aerated Lagoon with 300 m Setback
- Plan 3: Proposed Aerated Lagoon Expansion
- Plan 4: Dike Cross Section and Fence Details
- Plan 5: Silt Fence and Concrete Spillway Details
- Plan 6: Preliminary Building Layout

# Environment Act Proposal Form

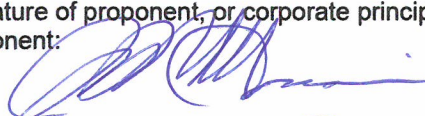

Name of the development: <b>La Broquerie Wastewater Treatment Lagoon Upgrade</b>	
Type of development per Classes of Development Regulation (Manitoba Regulation 164/88): <b>Class 2</b>	
Legal name of the applicant: <b>Rural Municipality of La Broquerie</b>	
Mailing address of the applicant: <b>PO Box 130</b>	
Contact Person: <b>Mr. Roger Bouvier</b>	
City: <b>La Broquerie</b>	Province: <b>Manitoba</b> Postal Code: <b>R0A 0W0</b>
Phone Number: <b>(204) 424 5151</b>	Fax: <b>(204) 424 5193</b> email: <b>cao@rmlabroquerie</b>
Location of the development: <b>RM of La Broquerie</b>	
Contact Person: <b>Mr. Roger Bouvier</b>	
Street Address:	
Legal Description: <b>NW1/4 of 31-6-8-EPM</b>	
City/Town: <b>RM of La Broquerie</b>	Province: <b>Manitoba</b> Postal Code: <b>R0A 0W0</b>
Phone Number: <b>(204) 424 5151</b>	Fax: <b>(204) 424 5193</b> email: <b>cao@rmlabroquerie</b>
Name of proponent contact person for purposes of the environmental assessment: <b>Jerry Cousin, JR Cousin Consultants Ltd.</b>	
Phone: <b>204-489-0474</b>	Mailing address: <b>91 A Scurfield Blvd</b>
Fax: <b>204-489-0487</b>	<b>Winnipeg, Manitoba</b>
<b>R3Y1G4</b>	
Email address: <b>jcousin@jrcc.ca</b>	
Webpage address: <b>www.jrcc.ca</b>	
Date: <b>14/12/18</b>	Signature of proponent, or corporate principal of corporate proponent: 
	Printed name: <b>Jerry Cousin</b>

## 1.0 INTRODUCTION AND BACKGROUND

The development described herein is for the upgrade and expansion of the existing Rural Municipality (RM) of La Broquerie wastewater treatment lagoon.

### 1.1 Introduction

The RM of La Broquerie is currently operating a facultative lagoon that requires expansion to meet projected growth. The RM of La Broquerie is proposing to convert the facultative lagoon into an aerated lagoon. The aerated lagoon works will include the construction of an aeration building, construction of two new aerated primary cells and converting all existing cells to storage cells. This last part will be addressed by leaving north primary and secondary cells as is and increasing the dike height of the south primary and storage cells.

An Environment Act Licence is required from Manitoba Conservation for the construction and operation of the upgraded lagoon. JR Cousin Consultants Ltd. (JRCC) was retained for the related engineering services.

### 1.2 Contact Information

Mr. Jerry Cousin, P.Eng.  
JR Cousin Consultants Ltd.  
91A Scurfield Blvd.  
Winnipeg, Manitoba  
R3Y 1G4  
Phone 204-489-0474, Fax 204-489-0487

Mr. Roger Bouvier  
Chief Administrative Officer  
Rural Municipality of La Broquerie  
PO Box 130  
La Broquerie, Manitoba  
ROA 0W0

### 1.3 Background Information

The existing lagoon will be expanded by adding two new aerated primary cells to treat the organics, raising the dikes of the existing south lagoons by 1.0 m to a total height of 2.1 m and leaving north primary and secondary as is. The new aerated primary cells would be constructed west of the existing lagoon cells within the NW 1/4 of 31-6-8-E. The RM will have to purchase land for the construction of the new lagoon cells.

A building, with three phase power, will be constructed to house the lagoon aeration equipment, chemical storage equipment and filtration equipment for phosphorus reduction. The building will also house a UV disinfection unit. The existing forcemain would be re-directed into the first aerated primary cell. A truck

turnaround and spillway at the new aerated primary cell would be constructed to accept truck hauled wastewater.

#### **1.4 Description of Previous Studies**

JRCC completed the *RM of La Broquerie Wastewater Treatment Lagoon Expansion Feasibility Study* in April 2013 that included an option for wastewater treatment via an aerated lagoon at the existing lagoon site.

A letter report entitled *RM of La Broquerie - Geotechnical and Topographic Investigation for the Aerated Wastewater Treatment Lagoon Expansion* was completed by JRCC in January 2014. JRCC conducted a topographic and geotechnical investigation for a wastewater treatment lagoon expansion and conversion to aeration. The potential lagoon expansion site investigated is west of the existing lagoon within the NW  $\frac{1}{4}$  of Section 13-06-08 EPM. This report outlines the findings of the geotechnical and topographic investigation at the proposed lagoon expansion site and evaluates the soils to determine their suitability for use as a lagoon liner as well as any potential difficulties associated with construction.

A letter report entitled *RM of La Broquerie – Lagoon Expansion Options* was completed by JRCC in March 2014. This report completed an assessment of three options for wastewater treatment for the RM of La Broquerie. It provided an outline of the work performed as part of our assessment and the results of the assessment including capital cost estimate.



## 2.0 DESCRIPTION OF THE DEVELOPMENT

For each heading there is an information request from the Information Bulletin - Environment Act Proposal Report Guidelines. These requests are repeated herein in italics followed by the pertaining response.

### 2.1 Land Title/Location

*Certificate of Title showing the owner(s) and legal description of the land upon which the development will be constructed; or, in the case of highways, rail lines, electrical transmission lines, or pipelines, a map or maps at a scale no less than 1:50,000 showing the location of the proposed development:*

The proposed lagoon expansion site is west of the existing lagoon within the NW  $\frac{1}{4}$  of Section 31-06-08 EPM. The land is currently being purchased by the RM of La Broquerie. The Certificate of Title for the NW  $\frac{1}{4}$  of Section 31-06-08 EPM (Title No. 1545837) is attached in Appendix A.

The RM is in the process of purchasing the remaining parcel of land required for the proposed aerated lagoon expansion (PT 70 in the NW  $\frac{1}{4}$  of 31-06-08 EPM). At the time of submitting the EAP document a signed agreement to purchase the land was not available. A signed document will be submitted to Manitoba Conservation when it is available.

### 2.2 Owner of Land and Mineral Rights

*Owner of land upon which the development is intended to be constructed, and of mineral rights beneath the land, if different from surface owner:*

The Crown Lands & Property Agency was contacted regarding the proposed development location. According to the Crown Lands & Property Agency records, the mines and minerals and sand and gravel in the NW  $\frac{1}{4}$  of Section 31-06-08 EPM are granted to individuals and the crown has no interest (see email correspondence from the Crown Lands & Property Agency, dated November 06, 2014 in Appendix A).

### 2.3 Existing Land Use

*Existing land use on the site and on land adjoining it, as well as changes that will be made in such land use for the purposes of the development:*

The proposed lagoon expansion site, currently agricultural land that is not in use, is directly west of the existing lagoon cells. The site is bordered to the west by a meandering creek and to the north by the lagoon access road, shown on Plan L2 in Appendix C.

Soil would be excavated in the area of the proposed lagoon expansion for construction of the lagoon dikes and drainage ditches. The sewage treatment building would be constructed on the northwest side of the proposed aerated primary cells.

## 2.4 Land Use Designation/Zoning Designation

*Land use designation for the site and adjoining land as identified in a development plan adopted under The Planning Act or The City of Winnipeg Act, and the zoning designation as identified in a zoning by-law, if applicable:*

The existing lagoon site and lagoon expansion site are currently zoned DR (Development Reserve), based on the zoning designations in the RM of La Broquerie. A public utility service (i.e. wastewater treatment lagoon) is permitted under the zoning designation, see e-mail correspondence from the RM sent November 19, 2014 Appendix A.

### 2.4.1 Land Classification

According to the Agriculture and Agri-Food Canada Manitoba Agri-Map the proposed lagoon expansion site has a “coarse-moderately coarse” surface texture, a slope of “0 – 2%”, “imperfect” soil drainage, “severe limitations” of the soil capability for agriculture and “very low” risk of water erosion. According to the Canada Land Inventory Soil Capability for Agriculture map for the Winnipeg region, the proposed lagoon expansion site is designated as  $(4\frac{7}{s}5\frac{3}{s}w)$ , which means Class 4 and Class 5 in a 7:3 ratio. The soils with a Class 4 rating have a soil limitation (4S) and the soils with a Class 5 rating have excess water and soil limitations (5WS).

According to the Nutrient Management Regulation 62/2008, soils designated as Class 4 are part of water quality management zone N2 and soils designated as Class 5 are designated as Zone N3. As the site is located in water quality management Zone N2 or N3 there are no restrictions for construction of a wastewater treatment lagoon.

The Seine River is not designated as a “vulnerable water body” according to the Nutrient Management Regulation 62/2008.

## 2.5 Description of Development

*Description of proposed development and schedule for stages of the development, including proposed dates for planning, design, construction, commissioning, operation, and decommissioning and/or termination of operation (if known), identifying major components and activities of the development as applicable (e.g. access road, airstrip, processing facility, waste disposal area, etc.).*

### 2.5.1 Project Schedule

Lagoon design is proposed to begin upon the receipt of an environmental licence. Lagoon construction works are proposed to begin in the spring of 2015, dependent upon approval of funding. Commissioning and operation of the lagoon is proposed to begin upon completion of construction and after approval for use is obtained from Manitoba Conservation.

## 2.5.2 Basis for Proposed Lagoon Expansion Site Selection

Manitoba Conservation's guidelines for the location of a wastewater treatment lagoon (*Design Objectives for Wastewater Treatment Lagoons, Province of Manitoba*, Manitoba Conservation and Water Stewardship, September 2014) are outlined in the following table. A description of the proposed site in relation to each of the guidelines is also provided in the table.

**Table 1: Lagoon Expansion Site Location in Relation to Manitoba Conservation Guidelines**

Manitoba Conservation Guideline	Proposed Relation to Site
1. Lagoons must be located a minimum of 460 m from any center of population.	The proposed aerated lagoon cells will be within 460 m from the closest center of population. Please see note below.
2. Lagoons must be located a minimum of 300 m from any residence. (The distance is to be measured from the center line of the nearest dike), this distance is shown on Plan L2, attached in the Appendix C.	The existing facultative lagoon is over 300 m from the nearest resident. The proposed aerated lagoon cells will be within 300 m from the nearest resident. Please see note below.
3. Consideration should be given to sites in which prevailing winds are in the direction of uninhabited areas.	The prevailing winds are from the north and west. The lagoon is located east of the community.
4. Sites with an unobstructed wind sweep across the lagoon are preferred.	The site surrounding the proposed lagoon is the existing lagoon and agricultural field with no nearby windbreaks.
5. Areas that are habitually flooded shall be avoided.	The proposed new lagoon dikes will be constructed above the existing lagoon top of dike elevation that has no reports of flooding.
6. Sewage lagoons are to be designed and constructed such that the interior surface of the proposed lagoon is underlain by at least one metre of soil having a hydraulic conductivity of $1 \times 10^{-7}$ cm/sec or less. In areas sensitive to groundwater contamination, a flexible synthetic liner may be recommended.	Based on the geotechnical investigation, the in situ soils will be capable of providing a consistent permeability of $1 \times 10^{-7}$ cm/sec. A vertical cut-off wall constructed of re-compacted clay soils will be extended through the silt layer into the horizontal in situ liner.

**Note:** The lagoon expansion area is not located beyond all facultative lagoon setback distances required by Manitoba Conservation. However, the expansion cells that encroach the setbacks are aerated, and with constant aeration, there are no expected concerns with the location of the expansion cells. Plan L2, in Appendix C, shows the minimum setback distance requirements for the expanded lagoon to the closest local resident.

### 2.5.3 Lagoon Drainage Route

The existing discharge route would be used with the proposed expansion (see Plan L3 in Appendix C). The lagoon system discharges into the Seine River, which eventually flows into the Red River. There are two proposed methods for discharge:

1. Direct discharge from the building after UV disinfection during the summer months.
2. Discharge from the storage lagoons when weather permits (no ice at the discharge route). Once the lagoon cells have been drained, the effluent from the building will be discharged back into the storage cells.

#### 2.5.3.1 Flow in the Seine River

Flow information for the Seine River near La Broquerie is provided in Table 2: Mean Monthly Flow Data for the Seine River near Ste. Anne, Manitoba (Station No. 050H007). The flow information was obtained from Manitoba Conservation and Water Stewardship (see email correspondence from Manitoba Conservation and Water Stewardship, May 28, 2014 in Appendix B).

**Table 2: Mean Monthly Flow Data for the Seine River near Ste. Anne, Manitoba**

Month	Mean flow for Station 050H007 (m <sup>3</sup> /s)
March	0.47
April	4.18
May	3.21
June	2.01
July	0.76
August	0.20
September	0.19
October	0.55

#### 2.5.3.2 Seine River Fish Species

The complete list of fish known to inhabit the Seine River is shown below:

- Brown Bullheads
- Black Bullheads
- Rock Bass
- White Sucker
- Northern Pike
- Emerald Shiner
- Goldeye
- Brook Stickleback
- Walleye
- Pearl Dace
- Carp
- Burbot
- Fresh Water Drum
- Shorthead Redhorse
- Longnose Dace
- Tadpole Madtom
- Common Shiner
- Goldfish
- Spottail Shiner
- Black Crappie
- Black Darter
- Johnny Darter
- Trout Perch
- Various Species of Minnows

\*Source: Gauder, Bernard. A Fish, Fauna and Habitat Quality Study of the Seine River, Manitoba, 1997

See email correspondence from Manitoba Conservation and Water Stewardship – Fisheries Branch, December 8, 2014 in Appendix B.

In a study conducted by Aquatic and Environmental Consultants Ltd. entitled *Seine River Watershed Study*, it was noted that the diversion structure at Ste. Anne does not appear to be passable by fish moving upstream under elevated flow conditions and that fish passage is also blocked between Ste. Anne and Winnipeg. Therefore, the number of fish species in the Seine River near La Broquerie would be limited.

The community of La Broquerie is at an elevation approximately 50 m above Winnipeg. Therefore, even during flood conditions, fish passage as far upstream as La Broquerie would be limited.

### 2.5.3.3 Seine River Water Quality

Information on the water quality of the Seine River was provided by Manitoba Conservation and Water Stewardship – Water Science and Management Branch on November 14, 2014.

The information provided included measurements from 21 stations along the Seine River near La Broquerie. Although some stations present data since 1973, the information is not constant and most of the stations do not offer all the parameters all the time. For these reasons, the average values are estimated for the most recent samples:

- Ammonia: <1 mg/L
- Total Organic Carbon: 14 mg/L
- Fecal coliforms: 1,450 MPN/100 mL
- Total Phosphorus: <0.5 mg/L
- pH: 8.0.

## 3.0 LAGOON SIZING

### 3.1 Population

The following brief population review is an update to the *RM of La Broquerie Wastewater Treatment Lagoon Expansion Feasibility Study* completed by JRCC in April of 2013.

The 2011 to 2016 population projections for the community of La Broquerie and the rural residents were provided by the RM based on housing starts and an average population density in the community of 2.74 people/residence and in rural of 3.67 people/residence. Beyond 2016, population growth is expected to continue at 2.31% in the community and 1.84% in the rural population (see Table 1: Population, Hydraulic, and Organic loading projections for The RM of La Broquerie Lagoon in Appendix B). The following is a summary of projected population increase from 2013 to 2033.

**Table 3: Summary of population projections for the RM of La Broquerie**

Year	Design Year	Community of La Broquerie	RM of La Broquerie Rural	Entire RM
2013	0	1,252	4,514	5,766
2014	1	1,367	4,661	6,028
2015	2	1,425	4,789	6,214
2016	3	1,466	4,881	6,347
<b>2033</b>	<b>20</b>	<b>2,160</b>	<b>6,655</b>	<b>8,815</b>

According to conversations with local septic tank haulers, approximately 95% of the rural residences in the RM are serviced by septic tanks and 5% are serviced by holding tanks. This ratio is expected to continue until design year 20.

### 3.2 Hydraulic Loading Rate

#### 3.2.1 Community of La Broquerie

A lift station hour meter reading program commenced in spring of 2013. JRCC reviewed available readings from March 13, 2013 to October 27, 2014. The following table represents the average per capita wastewater sent to the lagoon on a monthly basis.

**Table 4: Summary of hydraulic loadings for the Community of La Broquerie**

Month	Average Flow (m <sup>3</sup> /day) without Hy-Life*	Average Per Capita Flow** (L/person/day)	Total Precip.*** (mm)
March 2013	468	357.1	0.5
April 2013	457	348.8	33.5
May 2013	516	393.9	69
June 2013	477	364.6	62.5
July 2013	342	261.4	80
August 2013	327	249.6	41.5
September 2013	453	346.1	34.5

Month	Average Flow (m <sup>3</sup> /day) without Hy-Life*	Average Per Capita Flow** (L/person/day)	Total Precip.*** (mm)
October 2013	338	258.3	7.2
November 2013	275	209.7	4.9
December 2013	268	204.9	7.4
January 2014	256	195.3	15
February 2014	540	412.7	8.4
March 2014	669	511.0	9.0
April 2014	590	450.6	40.1
May 2014	833	636.0	42.1
June 2014	727	555.3	147.1
July 2014	720	549.6	25.4
August 2014	342	261.3	104.4
September 2014	773	590.3	40.7
October 2014	376	286.8	3.4
<b>Average (Summer Period)</b>	<b>458.9</b>	<b>350.4</b>	-
<b>Average (Winter Period)</b>	<b>519.8</b>	<b>396.9</b>	-
<b>Average (Total)</b>	<b>487.4</b>	<b>372.2</b>	-

\*Average water usage by Hy-Life of 49.1 m<sup>3</sup>/day subtracted from average daily water use.

\*\*Based on average 2013-2014 population of 1,309 people.

\*\*\*Total Precipitation for Winnipeg - No data available for La Broquerie.

Based on review of the data, the average per capita wastewater production during the 230 day winter storage period was 397 L/person/day. Based on review of daily lift station readings there is likely infiltration into the system as higher readings were recorded during warm days in spring (snow melt) and after high precipitation events.

Wastewater from a wet year (2012) was estimated based on the lagoon capacity. According to RM personnel the lagoon was approximately 0.4 m from the top of dike in June 2013 and was left with 0.6 m to 0.9 m of liquid in October of 2012. Therefore the per capita wastewater production from the community would have ranged between 370 – 460 L/person/day during the storage period.

Based on review of similar sized communities in Manitoba the average wastewater production rates can vary up to and higher than 200 L/person/day between a wet and dry year, especially if there is significant infiltration into the system.

Based on the lack of multiple years of data for La Broquerie, a dry year wastewater production rate of 397 L/person/day and a potential wet year rate of 370 – 460 L/person/day, a design wastewater production rate of 400 L/person/day will be used.

### 3.2.2 Rural Residents in the RM

The hydraulic loading from the rural residents serviced by septic tanks has been based on the typical septage generation rate of 200 L/person/year. Septic tanks are pumped out on average once per year and the average septic tank volume in the RM is 3,500 L (750 lgal). When septic tanks are pumped out the highly concentrated septage, along with typical domestic sewage, are pumped out. Therefore the average hydraulic loading per household will be 3,500 L/year, which is approximately 954 L/person/year based on a rural housing density of 3.67 people/residence. Septage from septic tank pump outs can be hauled to the lagoon during a 135 day summer period.

The rural residents serviced by holding tanks can be assumed to have a lower water consumption rate than the community residents on the piped system due to water conservation habits. Water consumption at the low end of the typical range of 225 L/person/day will be used for the rural residents serviced by holding tanks.

### 3.2.3 Additional Sources

The Hy-Life Truck Wash station uses considerable water volumes to wash waste from hog transport trucks and has been included in loading calculations. According to a water meter installed on the truck wash, the average water use is 343,685 L/week (75,600 lgal/week), which works out to an average daily loading of 49,098 L/day. A safety factor of 1.5 was applied to the average water meter reading to account for any potential increases in water use or expansion over the design period.

Including the safety factor, the average daily water use of the truck wash is 73,650 L/day. The truck wash uses an equivalent water use to 184 people with a water consumption of 400 L/person/day.

The solid waste from washing out the hog trucks is collected with straw and hauled away. The residual solid waste in the wash water is controlled by a series of baffles in the wash bay floor and collected in a septic tank and hauled from the site. The remaining wastewater that is sent to the lagoon has the majority of the solids removed and is diluted with the wash water.

The remaining wastewater was assumed to have the equivalent BOD<sub>5</sub> concentration of residential waste for previous reports. A wastewater sample from the truck wash was collected and analyzed by ALS Environmental on October 31, 2014 to confirm the organic and nutrient loadings. According to this report, the remaining wastewater has a BOD<sub>5</sub> of 70 mg/L. Considering that the daily average water usage is 49.1 m<sup>3</sup>/day; this would represent a total of 3.44 kg BOD<sub>5</sub>/day, a much lower value than the assumed 14.0 kg BOD<sub>5</sub>/d. The higher value will be used as an additional safety factor.



### 3.2.4 Summary of Hydraulic Loading

A summary of the projected hydraulic loading in design year 20 (2033) is outlined in Table 5 below, which are presented in detail in Table 1: Population, Hydraulic, and Organic Loading Projections for the RM of La Broquerie Lagoon in Appendix A.

**Table 5: Summary of Total 20 Year (2033) Design Hydraulic Loading to the Facility per Day**

Description	Average Day Flow (m <sup>3</sup> )
Community of La Broquerie	864
Septic Tank Cleanouts	44.7
Holding Tank Cleanout	74.9
Additional Sources	73.6
<b>Total</b>	<b>1057</b>

From Table 1: Population, Hydraulic, and Organic Loading Projections for the RM of La Broquerie Lagoon in Appendix A the required storage capacity of the aerated lagoon based on design year 20 loadings is 182,255 m<sup>3</sup> with 180 days of storage.

### 3.3 Organic Loading Rate

The organic loading calculation is based on the organics in typical residential wastewater. A value of 0.076 kg BOD<sub>5</sub>/person/day was utilized to estimate the organic loading from the residents from the community of La Broquerie, rural residents serviced by holding tanks and for wastewater from the Hy-Life Truck Wash.

An average organic strength of 1.64 kg BOD<sub>5</sub>/m<sup>3</sup> was utilized to calculate the organic loading from rural residents serviced by septic tanks. The organic strength was calculated based on 735 L of septage at a concentration of 7.0 kg BOD<sub>5</sub>/m<sup>3</sup> and 2,765 L of domestic sewage at a concentration of 0.21 kg BOD<sub>5</sub>/m<sup>3</sup>, per pump out. Based on a septic tank pump out of 3,500 L, each household would produce 5.7 kg BOD<sub>5</sub>/year.

A truck load of wastewater from septic tank pump-outs has a calculated organic load of 11.4 kg BOD<sub>5</sub> based on an average septic truck volume of 8,200 L (1,800 gal), which is capable of pumping out two-3,500 L septic tanks with a loading of 5.7 kg BOD<sub>5</sub> per house.

In design year 20 there will be a total of 1,723 houses on septic tanks which corresponds to 862 total truck loads per year. If hauling is assumed to only occur on weekdays there are 96 days available for hauling (135 days x 5/7) over the allowable period. Therefore there will be nine daily truck loads to the lagoon. The organic loading from nine truckloads of septic tank pump outs will be 102.6 kg BOD<sub>5</sub>/day.

The total organic loadings from all sources are as follows:

- Community of La Broquerie - 164.2 kg BOD<sub>5</sub>/day (2,160 people x 0.076 kg BOD<sub>5</sub>/day)
- Rural residents on septic tanks – 102.6 kg BOD<sub>5</sub>/day (9 trucks/day x 11.4 kg BOD<sub>5</sub>/truck)

- Rural residents on holding tanks – 25.3 kg BOD<sub>5</sub>/day (333 people x 0.076 kg BOD<sub>5</sub>/day)
- Hy-Life Truck Wash – 14.0 kg BOD<sub>5</sub>/day (184 equivalent people x 0.076 kg BOD<sub>5</sub>/day)
- **Total – 306.1 kg BOD<sub>5</sub>/day.**

## 4.0 LAGOON STORAGE CAPACITY

### 4.1 Lagoon Storage Period

Typically, facultative lagoons are required to maintain 230 days of storage (November 1 to June 15). Discussions have been completed with Manitoba Conservation to allow for discharge earlier in the spring (April 16) due to enhanced treatment from aeration of the primary cells, chemical addition, sand filtration and UV disinfection. This early discharge would be done from the building (after filtration and disinfection) where an acid feed can be added for pH adjustment to comply with effluent ammonia standards.

JRCC is hereby requesting an allowable discharge period of April 16 to October 31 (166 days of winter storage).

The storage cells will be sized to accommodate storage from November 1 to April 30 (180 days of winter storage) to provide a small buffer for spring conditions hindering early discharge.

### 4.2 Storage Cells

The existing lagoon will be expanded by adding two new aerated primary cells to treat the organics. Additionally, the dikes of the existing south lagoons (Primary Cell 2 and Storage Cell 2) will be raised 1.0 m. A storage cell operating depth of 2.5 m would have some risk of the effluent becoming anaerobic and decreasing the wastewater quality unless additional aeration is provided to the cell. To avoid this, the operating depth in the storage cells will be of 2.1 m. If the 2.5 m depth is to be used in future, aeration can be added to the cells at that time.

A building will be constructed to house the lagoon aeration equipment and chemical storage equipment for phosphorus reduction and pH adjustment. The building would also house a UV disinfection unit. The building will require three phase power. The existing forcemain would be re-directed into the building aerated primary cell. A truck turnaround and spillway would be constructed to accept truck hauled wastewater.

## 5.0 LAGOON SEWAGE TREATMENT

### 5.1 Lagoon Treatment Requirements

A review of the *Wastewater System Effluent Regulations* June 28, 2012 and the *Manitoba Water Quality Standards, Objectives and Guidelines* November 28, 2011 was completed. The following table summarizes the treatment requirements:

**Table 6: Summary of Federal and Provincial effluent quality requirements**

Parameter	Federal Requirement	Provincial Requirement
cBOD <sub>5</sub>	25 mg/L	25 mg/L
BOD <sub>5</sub>		25 mg/L
Suspended Solids	25 mg/L	25 mg/L
Un-ionized Ammonia expressed as nitrogen (N) at 15°C	<1.25 mg/L	
Fecal Coliforms		200 per 100 mL
Phosphorus		1.0 mg/L

### 5.2 Lagoon Treatment Equipment

The proposed lagoon will treat BOD from the wastewater utilizing two deep aerated primary cells operated in series each with a combined retention time of 57 days at design year 20 flow rates. Air will be provided to the cells with two blowers with a third on standby. The blowers will provide the air through HDPE headers, floating laterals and fine bubble diffusers.

A continuous backwash gravity sand filter system with ferric chloride addition will be utilized to reduce phosphorus to < 1 mg/L. Effluent from the filters is low in TSS and is suitable for UV disinfection.

A sewage treatment building will be constructed to house the treatment equipment as well as an office, washroom, etc. The building will be pre-engineered steel with a brick veneer exterior with a footprint of 162 m<sup>2</sup>.

Treated effluent from the sewage treatment plant building will be directed into the storage cells during the winter storage period and directly to the Seine River during the summer discharge period.

## 6.0 GEOTECHNICAL AND TOPOGRAPHY REVIEW

### 6.1 Geotechnical Investigations

A geotechnical and topographic investigation of the proposed lagoon expansion site titled *RM of La Broquerie - Geotechnical and Topographic Investigation for the Aerated Wastewater Treatment Lagoon Expansion* was completed by JRCC in January of 2014.

The report indicated the lagoon expansion site consisted of an average of 1.5 m of sandy silt over an average of 4.0 m of medium to high plastic clay. Below the clay was a sandy, silty clay till, an average of 5.5 m below ground. Laboratory testing indicated the 4.0 m thick clay layer would be suitable for use as an in situ clay liner.

The new aeration cell will be constructed with vertical cut-off walls in the centre of the perimeter dikes, extended a minimum of 1.0 m into the in situ clay layer. The existing lagoon dikes will be raised with high plastic clay to extend the cut-off wall and silty sand as the inside and outside dike material.

Rip rap on the new aerated primary cells has been included in the cost estimates. Rip rap could be included on the raised south lagoon dikes and/or the north lagoon dikes to reduce the risk of erosion.

### 6.2 Topography

A topographic GPS survey of the test hole locations and existing ground across the proposed lagoon expansion site was completed on November 28 and December 3, 2013. The existing ground at the proposed expansion site slopes to the west. There are two large stockpiles of material from the previous lagoon expansion located at the south end of the proposed expansion site.

The top of dike elevation in the existing Primary Cell 1 and Storage Cell 1 is 282.0 m and the top of dike elevation in the existing Primary Cell 2 and Storage Cell 2 is 281.0 m.

The proposed expansion site has an elevation immediately west of the existing lagoon of approximately 281.0 m. The site slopes to the west with an elevation at the proposed new east dike of 280.0 m. The land continues to slope west towards the creek with an elevation at the treeline of approximately 278.0 m.

From the topographic survey data, the stockpiles are up to 4 m high and have an approximate total volume of 20,400 m<sup>3</sup>.

Contour lines from the topographic survey are shown on Plan L1, attached in Appendix C.

## 7.0 LAGOON OPERATION, MAINTENANCE AND DECOMMISSIONING

### 7.1 Operation and Maintenance

Maintenance of the aerated lagoon will include:

- Lagoon Cells and Access Roads
  - Maintaining the fencing, gate and lock
  - Ensuring the gate is locked at all times and only the local septic haulers and RM Public Works department have access to the site
  - Maintaining the intercell and discharge piping and valves
  - Maintaining grass cover on dikes to a height of no more than 0.3 m in height
  - Maintaining a program to prevent and remove burrowing animals
  - Maintaining the truck turnaround area and spillway
  - Clearing of snow from the lagoon access road, truck turnaround area and spillway
  - Completing effluent sampling prior to discharge.
- Sewage Treatment Equipment
  - Monitoring and service lift station pumps and meters
  - Recording and monitoring mag meters readings and lift station hour meters
  - Minimal cleaning and maintenance will be required for the diffuser. For cleaning, additional airflow will be introduced to the diffusers causing the membrane pores to flex, temporarily breaking off any formed precipitation or fouling. No chemical cleaning or water wash will be required
  - Replacing diffusers approximately every 12 years
  - Changing the filter for the aeration blowers every six months, oil changes every year and belt replacement every two years
  - Refilling phosphorus reduction chemical and adjusting dosage rates based on laboratory testing of the lagoon effluent
  - Replacing the airlift for the sand filters once per year
  - Checking UV bulbs and complete manual bulb cleaning where required. The UV will be equipped with an automatic wiping system as well as a chemical cleaning system to reduce operator maintenance
  - Completing general building cleaning and maintenance.

### 7.2 Sludge Management

#### 7.2.1 Aerated Primary Cells

In a typical facultative lagoon, solids in wastewater will settle to the bottom of the cell and accumulate as sludge. Oxygen is not available at the bottom of a facultative lagoon cell and thus the anaerobic sludge will accumulate over time. Based on past experience with facultative lagoons in Manitoba, sludge will require removal approximately every 20 - 25 years.

With aerated primary cells, the diffusers are suspended near the bottom of the cells which release fine bubbles up through the wastewater. Wastewater will rise with the bubbles and fall between the diffusers creating convection currents within the aerated primary cells. Solids in the wastewater will fall through the downward motion of the wastewater between the diffusers. When the sludge reaches the bottom of the cell, oxygen provided by the diffusers allows aerobic sludge digestion to take place at the sludge-wastewater interface. The process results in minimal organic sludge accumulation in the cells.

Backwash from the sand filters will be sent to the primary cell which contains phosphorus and suspended solids. This will accumulate in the primary cell as well. The sludge from the filter backwash will also undergo aerobic sludge digestion with the oxygen provided by the diffusers to reduce the quantity of sludge in the cells.

Sludge accumulation projections were provided by Nelson Environmental Inc. based on typical wastewater influent characteristics. It was calculated that the lagoon will generate approximately 5,427 m<sup>3</sup> of sludge over a 20 year time period. The total surface area in Primary Cell 1 and 2 is approximately 12,100 m<sup>2</sup>, which results in an average sludge depth in the cells of 0.45 m.

The actual sludge accumulation in the aerated primary cells should be evaluated after 20 years and removed if the actual depth is 0.5 m or greater.

### **7.2.2 Existing Primary Cells**

Sludge accumulation in the existing primary cells (future storage cells) is not expected to increase significantly once the aerated primary cells and filtration system is installed as the storage cells will be receiving fully treated effluent. The sludge will not be removed from any of the existing cells as part of the lagoon upgrade and expansion works.

## **7.3 Lagoon Decommissioning**

The existing lagoon cells will not be decommissioned as part of the lagoon upgrade and expansion works.

No date has been set for decommissioning of the upgraded and expanded lagoon system. The lagoon system is designed for design year 20 loadings, but with proper operation and maintenance could last well beyond the design period.

## 8.0 POTENTIAL ENVIRONMENTAL IMPACTS

*The biophysical and socioeconomic environment as related to the development, and potential impacts of the development on the environment.*

### 8.1 Releases to Air, Water, Land

#### 8.1.1 Air

In general, **facultative** lagoons may generate some odours for a short time each spring during the thawing or turn-over period when water temperature inversion causes turbulence in the lagoon cells and gases produced from the anaerobic treatment process are brought to the surface. **Aerated** lagoons provide oxygen to the wastewater year round, which prevents the lagoon from becoming anaerobic which greatly reduces the potential for odours.

There is potential for greenhouse gas emissions during construction works from heavy equipment and transport vehicles. Impacts from dust generation are not expected as the construction area will meet the minimal setback distances from residences.

Environmental management practices to mitigate the above potential impacts to the air are provided in Section 9.1 of this report.

#### 8.1.2 Water

Pollutants that may be released into surface and ground water during the operation of the lagoon include coliforms, organic wastes, suspended solids, and other materials that are typically disposed of into the sewer system. Pollutants in the wastewater produced by the community are expected to be residential in nature.

Pollutants that have a potential to be released into the surface or groundwater during the lagoon upgrade construction activities, include petroleum hydrocarbons (PHCs) from heavy equipment and sediments from soil erosion.

##### *Surface Water*

Surface water may be impacted if the wastewater is not sufficiently treated and subsequently discharged from the lagoon. Effluent discharged from the lagoon would flow into the Seine River and eventually reach the Red River. There is also potential to impact surface water via sedimentation from soil erosion in the discharge stream during the construction works.

The discharge from the lagoon should not cause or contribute to flooding in or along the drainage route. The lagoon would not be discharged during flood conditions. There is no potential to impact the navigation of surface waters as a result of the lagoon project, as the Seine River is not a navigable body of water.



### *Groundwater*

There is a potential for groundwater impacts if wastewater leaks/seeps through the lagoon liner or forcemain pipe and into the groundwater below. There is also a potential for groundwater impacts from equipment leaks or fuel spills during construction.

Environmental management practices to mitigate the above potential impacts to water are provided in Section 9.2 of this report.

#### **8.1.3 Land**

The land would be significantly altered by construction of the new lagoon dikes, perimeter ditching and access road. A building would also be constructed north of the lagoon.

Pollutants that may be released to the land are predominantly petroleum hydrocarbons, which could be released during construction activities. Equipment leaks, or re-fuelling incidences, could result in an impact to the land as a result of construction activities.

Disturbed areas can be impacted through soil erosion if not covered or re-vegetated. Environmental management practices to mitigate the above potential impacts to the land are provided in Section 9.3 of this report.

## **8.2 Wildlife**

The proposed lagoon site is located in the “Interlake Plain” Ecoregion of Canada. Characteristic wildlife includes white-tailed deer, black bear, moose, beaver, coyote, snowshoe hare, and eastern cottontail, as well as for waterfowl and colonial water birds like cormorant, gull, tern, heron, American white pelican, and grebe.

The Manitoba Conservation Data Centre was contacted regarding the proposed lagoon project and indicated that there were no occurrences of rare species at the proposed lagoon expansion site in their database. Refer to the Manitoba Conservation Data Centre email correspondence of November 18, 2014, attached in Appendix B.

Impacts to wildlife and wildlife habitat are not expected, as the lagoon expansion is to be located on agricultural land which is regularly disturbed by farming activities.

## **8.3 Fisheries**

Impact to fish along the discharge route is unlikely as the lagoon effluent would be discharged after fish spawning has normally occurred and only when the treated effluent meets current Manitoba Conservation water quality guidelines for surface discharge.

## 8.4 Forestry

There are no potential impacts to forestry as the area of lagoon expansion has been previously cleared due to agriculture and no forestry areas would be impacted.

## 8.5 Vegetation

Characteristic vegetation in the Interlake Plain ecoregion is classified as being a transitional area between areas of boreal forest to the north and aspen parkland to the southwest. It is a mix of trembling aspen/oak groves and rough fescue grasslands.

Manitoba Conservation Data Centre was contacted regarding occurrences of rare or endangered vegetative species in their database at the proposed lagoon expansion site. There were no occurrences of rare species identified at the development site. Refer to the Manitoba Conservation Data Centre email correspondence of November 18, 2014, attached in Appendix B.

No significant impacts to vegetation in the development area are anticipated, as the site is currently agricultural land which is disturbed regularly through farming activities.

## 8.6 Noise Impacts

There is a potential for noise impacts in the immediate area due to the heavy equipment utilized during construction. Mitigation measures described in Section 9.4 below will be in place during the construction works.

The blowers within the building will have self-contained sound attenuation enclosures that will limit the sound levels to approximately 73 dB(A). The only other potential sources for noise impacts will be the maintenance vehicles (for lagoon effluent sampling or mowing grass), septic hauling trucks, and periodic chemical delivery trucks.

## 8.7 Health and Safety

There is a potential for impacts to the health and safety of workers and the public during the construction works. Mitigation measures described in Section 9.5 below will be in place during the construction works.

## 8.8 Heritage Resources

The Manitoba Historic Resources Branch was contacted regarding the proposed site. The Historic Resources Branch indicated that the potential to impact significant heritage resources is low and that they have no concerns with the project. Refer to the Manitoba Historic Resources Branch e-mail correspondence dated November 27, 2014, attached in Appendix B.

While impacts to historic or heritage resources are not expected at the site, there is a potential for an unexpected discovery when excavating an area which has not previously been excavated. Mitigation measures described in Section 9.6 below will be in place during the construction works.

## **8.9 Socio-Economic Implications**

The lagoon expansion is not expected to have adverse socio-economic impacts. In fact, construction related economic activity is likely to have a positive economic impact on the community of La Broquerie. In addition, La Broquerie would have increased wastewater capacity upon completion of the project, which will encourage future development and growth.

## **8.10 Aesthetics**

The lagoon expansion is not expected to have adverse impacts on the general aesthetics of the area, as the lagoon construction would occur adjacent to the existing lagoon cells.

## 9.0 MANAGEMENT PRACTICE

*Proposed environmental management practices to be employed to prevent or mitigate adverse implications from the impacts identified above.*

### 9.1 Mitigation of Impacts to Air

To reduce the potential for odour nuisance in the community, the primary cell aeration system will be sized for the projected year 20 organic loadings, from the contributing populations. Nuisance odours as a result of organic loading are not expected due to the aeration system maintaining aerobic conditions year round.

Specifications should indicate that emissions from construction equipment and transport vehicles shall be controlled through regular maintenance, and shall meet all provincial and local standards. Dust suppression methods (i.e. water spraying) should be utilized at the construction site if dry conditions create excessive dust through construction activities and transport, which becomes a nuisance to nearby residents. Due to the setback distance, it is unlikely that dust will have any impact on the community or to nearby residents.

### 9.2 Mitigation of Impacts to Water

#### 9.2.1 Surface Water

Impacts to surface water from discharge of lagoon effluent are not expected, as the lagoon effluent would not be discharged unless Provincial and Federal discharge requirements are met, as follows:

1. The organic content of the effluent, as indicated by the five day biochemical oxygen demand would not be greater than 25 mg/L
2. The total suspended solids would not be greater than 25 mg/L
3. The fecal coliform content of the effluent, as indicated by the MPN index would not be greater than 200 per 100 ml of sample, or Escherichia coli content not greater than 200 per 100 ml of sample.
4. The total phosphorus content of the effluent would not exceed 1 mg/L
4. The un-ionized ammonia expressed as nitrogen (N) at 15°C content of the effluent would not exceed 1.25 mg/L.

Erosion from excess material stockpiles would be prevented by the use of silt fencing at drainage locations and by either covering the soil stockpiles or seeding with grass. Clean rock (free of fine materials) from an appropriate land-based source would be utilized to eliminate occurrence of erosion at the lagoon discharge outlet. Silt fencing would be installed in the perimeter ditching during construction and should remain in place until grass growth is established. Perimeter ditch slopes would be seeded with grass to control erosion and sediment entry into the discharge route. Disturbance of the soils adjacent to the perimeter ditches and discharge route would be minimized during construction.

To minimize impacts from construction equipment on surface waters, the construction specifications should outline to the contractor the requirements for handling and storage of fuels and hazardous materials during construction, as per Federal and Provincial regulations. The specification should state wording similar to the following:

- Diesel or gasoline should be stored in double walled tanks or have containment dikes around fuel containers for volumes greater than 68.2 L (15 gallons) or in compliance with provincial regulations
- Clean up material should be available at the site, consisting of a minimum of 25 kg of suitable commercial sorbent, 30 m<sup>2</sup> of 6 mil PVC, and an empty fuel barrel for spill collection and disposal
- Fuel storage and hazardous material areas established for project construction should be located a minimum of 100 m from a waterbody, and comply with provincial regulations
- Waste hazardous materials from construction activities and equipment must be properly collected and disposed of in compliance with provincial regulations
- In the event of spills or leaks of fuels and hazardous materials, the contractor or operator should notify the project engineer and Provincial Authorities.

Hazardous material handling and storage are to follow all Provincial and Federal regulations including WHMIS and spill containment requirements.

The specifications should state that when working near water with construction equipment:

- Construction equipment is to be properly maintained to prevent leaks and spills of fuels, lubricants, hydraulic fluids or coolants
- There can be no re-fueling or servicing of construction equipment within 100 m of a water body.

There would be no impacts to navigation as a result of the lagoon project, as the discharge route to the Seine River is not a navigable body of water. If flooding occurs along the drainage route, the RM must not discharge the lagoon. The discharge should not cause or contribute to flooding in or along the drainage route.

### 9.2.2 Groundwater

Seepage of effluent from the lagoon is unlikely to affect groundwater as the new lagoon primary cells would utilize a clay liner, having a hydraulic conductivity less than  $1 \times 10^{-7}$  cm/sec, as required by Manitoba Conservation guidelines.

Mitigation of potential impacts to groundwater during the lagoon construction activities from fuel handling, equipment leaks or fuel spills, would follow the same procedures as described in Section 9.2.1 above.

### **9.3 Mitigation of Impacts to Land**

The lagoon will utilize the in situ high plastic clay as the horizontal liner under the existing and proposed wastewater treatment lagoon cells. A vertical cut-off wall will be extended through the silty clay layer into the high plastic clay layer surrounding the new and proposed lagoon cells to completely seal the lagoon.

To minimize the potential for the release of Petroleum Hydrocarbon pollutants into the soil, the mitigation measures described in Section 9.2.1 above outlining fuel-handling procedures should be followed.

To minimize the potential for slope erosion, the outside slopes of the dikes would be constructed with a 5:1 slope and the dike tops, outside slopes and soil stockpiles would be seeded with grass. The discharge outlet location would be covered with rip-rap to eliminate soil erosion into the ditch during discharge events.

### **9.4 Mitigation of Noise Impacts**

To minimize the potential for noise impacts, the specification should indicate that construction equipment and transport vehicles should have mufflers working properly, and construction activities should be limited to daylight hours only.

The aeration blowers would have self-contained sound attenuation enclosures which will should limit the sound levels to approximately 73 dB(A).

### **9.5 Mitigation of Impacts to Health and Safety**

To minimize impacts to health and safety of workers and the public, the construction specifications should state that the Contractor have a safety program in place, in accordance with all Federal and Provincial Health and Safety Regulations. During construction, site access will be limited to the construction crew only. Personal protective equipment will be worn in accordance with the contractor's safety program.

### **9.6 Mitigation of Impacts to Heritage Resources**

If any significant historic or heritage resources are discovered in the course of excavation or construction, the specifications should identify that works are to temporarily cease and an investigation of the site is to be conducted by the RM, Manitoba Historic Resources Branch and any other authority as may be required.

## 10.0 RESIDUAL AND CUMULATIVE EFFECTS

*Residual environmental effects remaining after the application of mitigation measures, to the extent possible expressed in quantitative terms relative to baseline conditions*

No negative residual effects are anticipated through the construction and operation of the upgraded wastewater treatment lagoon, due to the mitigation measures described above. Positive residual effects are expected from the properly sized wastewater treatment system, which will allow for future development and expansion of the RM of La Broquerie.

## 11.0 MONITORING AND FOLLOW-UP

*Proposed follow-up activities that will be required at any stage of development (eg. Monitoring, inspection, surveillance, audit, etc.)*

Monitoring of the lagoon operation is to be conducted by a trained lagoon operator, who is to ensure the lagoon is operated under the requirements of the environmental licence. The operator is to ensure liquid levels in the lagoon cells are maintained within the required limits, conduct sampling of lagoon effluent prior to discharge, and is to ensure water quality guidelines as described in the environmental licence are met. The lagoon operator would also be responsible for the operation and maintenance activities described in Section 7.1.

The construction contractor is to ensure that grass growth occurs on slopes and disturbed areas, after the construction activities are completed.



## 12.0 FUNDING AND APPROVALS

*Name and address of any Government Agency or program (federal, provincial or otherwise) from which a grant or loan of capital funds have been requested (where applicable). Other federal, provincial or municipal approvals, licences, permits, authorizations, etc. known to be required for the proposed development, and the status of the project's application or approval.*

Funding for this project will be through the Rural Municipality and other possible derived sources i.e. MWSB. No additional approvals, licences or permits are required for the lagoon construction and operation.

## 13.0 PUBLIC CONSULTATION

*Results of any public consultations undertaken or to be undertaken in conjunction with project planning.*

Public consultation by the RM of La Broquerie has not been conducted to date. Public comments will be received by Manitoba Conservation through the public registry during the Environmental Act Proposal review period.

## 14.0 CONCLUSION

Based on the design of the project and the implementation of the mitigation measures identified in Section 9.0 above, no significant negative environmental impacts are anticipated.

The proponent would like to complete the requirements of the Environment Act Proposal as soon as possible so that the lagoon construction can begin by the time specified in Section 2.5.1 above.

JR Cousin Consultants Ltd. requests that a draft copy of the license be forwarded for review prior to the issue of the final license.

## **APPENDIX**

### **Appendix A**

Table 1: Population, Hydraulic, and Organic Loading Projections for the RM of La Broquerie Lagoon  
RM of La Broquerie, Land Titles and Zone Designation, November 19, 2014  
Crown Lands & Property Agency, Email Correspondence November 06, 2014

### **Appendix B**

Manitoba Conservation and Water Stewardship, 7Q10 Flows Seine River. Email Correspondence May 28, 2014  
Manitoba Conservation and Water Stewardship, Fisheries Branch. Email Correspondence December 8, 2014  
Manitoba Conservation Data Centre, Species at Risk. Email Correspondence November 18, 2014  
Manitoba Historic Resources Branch. Email Correspondence November 27, 2014

### **Appendix C**

Title Plan

- Plan 1: Test Hole Locations and Contour Lines
- Plan 2: Proposed Aerated Lagoon with 300 m Setback
- Plan 3: Proposed Aerated Lagoon Expansion
- Plan 4: Dike Cross Section and Fence Details
- Plan 5: Silt Fence and Concrete Spillway Details
- Plan 6: Preliminary Building Layout

## **Appendix A**

Table 1: Population, Hydraulic, and Organic Loading Projections for the RM of La Broquerie Lagoon

RM of La Broquerie, Land Titles and Zone Designation, November 19, 2014

Crown Lands & Property Agency, Email Correspondence November 06, 2014

Table 1: Population, Hydraulic, and Organic Loading Projections for the RM of La Broquerie Lagoon

TABLE 1

POPULATION, HYDRAULIC, AND ORGANIC LOADING PROJECTIONS FOR THE RM OF LA BROQUERIE LAGOON

Col 1	Col 2	Col 3	Col 4	Col 5	Col 6	Col 7	Col 8	Col 9	Col 10	Col 11	Col 12	Col 13	Col 14	Col 15	Col 16	Col 17	Col 18	Col 19
PROJECT YEAR	YEAR	POPULATION				ORGANIC LOADING						HYDRAULIC LOADING						
		POPULATION GROWTH PER YEAR Community of La Broquerie (piped system)	RM OF LA BROQUERIE RURAL RESIDENTS  Serviced by Septic Tanks (95%)	RM OF LA BROQUERIE RURAL RESIDENTS  Serviced by Holding Tanks (5%)	HY-LIFE TRUCK WASH EQUIVALENT RESIDENT LOADINGS  Based on Average Hour Meter Readings	CAPITA BOD  Piped and Holding Tanks  [kg]	BOD PRODUCTION  Average Concentration from Septic Tanks  [kg/m <sup>3</sup> ]	DAILY BOD PRODUCTION  Piped and Holding Tanks (Winter Loadings)  [kg]  (Col 3 + Col 5 + Col 6)*Col 7	DAILY BOD PRODUCTION  Average Loadings from Septic Tanks  [kg]  Truck Loads Required over 96 days at 11.4 kg BOD <sub>5</sub> /load	DAILY BOD PRODUCTION  Total (Summer Loadings)  [kg]  Col 9 + Col 10	SURFACE AREA REQ'D AT 0.75 M DEPTH (For a Facultative Lagoon)  [m <sup>2</sup> ]  (Col 11/56 kgBOD <sub>5</sub> /ha)* 1000	DAILY/CAPITA WASTEWATER PRODUCTION  Including Infiltration  [L/person/day]	DAILY/CAPITA WASTEWATER PRODUCTION  Rural Residents on Holding Tanks  [L/person/day]	YEARLY/CAPITA SEPTAGE PRODUCTION From Rural Residents on Septic Tanks  [L/person/year]  3,500 L/3.67 people	TOTAL DAILY WASTEWATER PRODUCTION During the 135 Summer Discharge Period  [m <sup>3</sup> /day]  *	TOTAL DAILY WASTEWATER PRODUCTION During the 230 day Winter Storage Period  [m <sup>3</sup> /day]  **	230 Day WASTEWATER PRODUCTION (Facultative Lagoon)  [m <sup>3</sup> ]  Col 19 * 230	180 Day WASTEWATER PRODUCTION (Aerated Lagoon)  [m <sup>3</sup> ]  Col 19 * 180
		2.31% Growth/year	1.84% Growth/year	1.84% Growth/year	0.00% Growth/year													
0	2011	1,073	3,919	206	184	0.076	1.64	111.2	68.4	179.6	32,069	400	225	954	576.8	549.2	126,305	98,847
0	2012	1,142	4,107	216	184	0.076	1.64	117.2	68.4	185.6	33,141	400	225	954	608.0	579.0	133,170	104,220
0	2013	1,252	4,288	226	184	0.076	1.64	126.3	79.8	206.1	36,806	400	225	954	655.5	625.3	143,808	112,545
1	2014	1,367	4,428	233	184	0.076	1.64	135.6	79.8	215.4	38,461	400	225	954	704.1	672.8	154,750	121,109
2	2015	1,425	4,550	239	184	0.076	1.64	140.4	79.8	220.2	39,330	400	225	954	729.5	697.4	160,396	125,528
3	2016	1,466	4,637	244	184	0.076	1.64	143.9	79.8	223.7	39,954	400	225	954	747.7	714.9	164,427	128,682
4	2017	1,500	4,723	249	184	0.076	1.64	146.9	79.8	226.7	40,484	400	225	954	763.0	729.6	167,814	131,333
5	2018	1,535	4,810	254	184	0.076	1.64	149.9	79.8	229.7	41,026	400	225	954	778.7	744.8	171,293	134,055
6	2019	1,570	4,898	258	184	0.076	1.64	152.9	79.8	232.7	41,556	400	225	954	794.3	759.7	174,720	136,737
7	2020	1,606	4,988	263	184	0.076	1.64	156.0	91.2	247.2	44,148	400	225	954	810.4	775.2	178,290	139,532
8	2021	1,643	5,080	268	184	0.076	1.64	159.2	91.2	250.4	44,718	400	225	954	827.0	791.1	181,953	142,398
9	2022	1,681	5,173	273	184	0.076	1.64	162.5	91.2	253.7	45,301	400	225	954	844.0	807.4	185,708	145,337
10	2023	1,720	5,268	278	184	0.076	1.64	165.8	91.2	257.0	45,899	400	225	954	861.4	824.2	189,555	148,347
11	2024	1,760	5,365	283	184	0.076	1.64	169.3	91.2	260.5	46,509	400	225	954	879.2	841.3	193,493	151,430
12	2025	1,800	5,464	288	184	0.076	1.64	172.7	91.2	263.9	47,120	400	225	954	897.0	858.4	197,432	154,512
13	2026	1,842	5,564	293	184	0.076	1.64	176.2	91.2	267.4	47,758	400	225	954	915.6	876.3	201,555	157,739
14	2027	1,884	5,667	299	184	0.076	1.64	179.9	102.6	282.5	50,445	400	225	954	934.5	894.5	205,729	161,006
15	2028	1,928	5,771	304	184	0.076	1.64	183.6	102.6	286.2	51,110	400	225	954	954.0	913.2	210,036	164,376
16	2029	1,972	5,877	310	184	0.076	1.64	187.4	102.6	290.0	51,789	400	225	954	973.7	932.2	214,395	167,787
17	2030	2,018	5,985	315	184	0.076	1.64	191.3	102.6	293.9	52,481	400	225	954	994.0	951.7	218,885	171,302
18	2031	2,064	6,095	321	184	0.076	1.64	195.2	102.6	297.8	53,186	400	225	954	1,014.5	971.4	223,428	174,857
19	2032	2,112	6,207	327	184	0.076	1.64	199.3	102.6	301.9	53,919	400	225	954	1,035.8	992.0	228,154	178,556
20	2033	2,160	6,322	333	184	0.076	1.64	203.5	102.6	306.1	54,652	400	225	954	1,057.2	1,012.5	232,881	182,255

\*[(Col 3\*Col 15) + (Col 4\*Col 17/135) + (Col 5\*Col 16) + (Col 6\*Col 13)]/1000

RM of La Broquerie, Land Titles and Zone Designation, November 19, 2014



**From:** [Brett McCormac](#)  
**To:** ["Mario Poveda"](#)  
**Subject:** FW: Attached Image  
**Date:** Wednesday, November 19, 2014 2:36:55 PM  
**Attachments:** [2212\\_001.pdf](#)

---

Brett McCormac, E.I.T.  
Environmental Engineer-in-Training  
J.R. Cousin Consultants Ltd.  
Phone: (204) 489-0474  
Fax: (204) 489-0487  
[www.jrcc.ca](http://www.jrcc.ca)

\*\*\*

The information contained in this email and any attachments is privileged, confidential and subject to copyright. It is intended solely for the use of the person(s) to whom it is addressed. If you receive this email in error, please notify the sender by return email and permanently delete it from your system. Note: We have taken precautions against viruses, but take no responsibility for loss or damage caused by any virus present.

---

**From:** Roger Bouvier [<mailto:cao@rmlabroquerie.ca>]  
**Sent:** November-19-14 2:26 PM  
**To:** Brett McCormac  
**Subject:** FW: Attached Image

Brett, further to your message, please find attached a copy of certificate of titles for the lagoon property. The land is presently zoned DR – Development reserve. We don't have a signed document with the present land owner. Our lawyer is still waiting for his signature. Hope to have something in the next few days and will forward something as soon as I receive it. Roger B.

**From:** [donotreply@rmlabroquerie.ca](mailto:donotreply@rmlabroquerie.ca) [<mailto:donotreply@rmlabroquerie.ca>]  
**Sent:** Wednesday, November 19, 2014 2:22 PM  
**To:** Roger  
**Subject:** Attached Image



Zone of parcel to be acquired: **DR – DEVELOPMENT RESERVE**

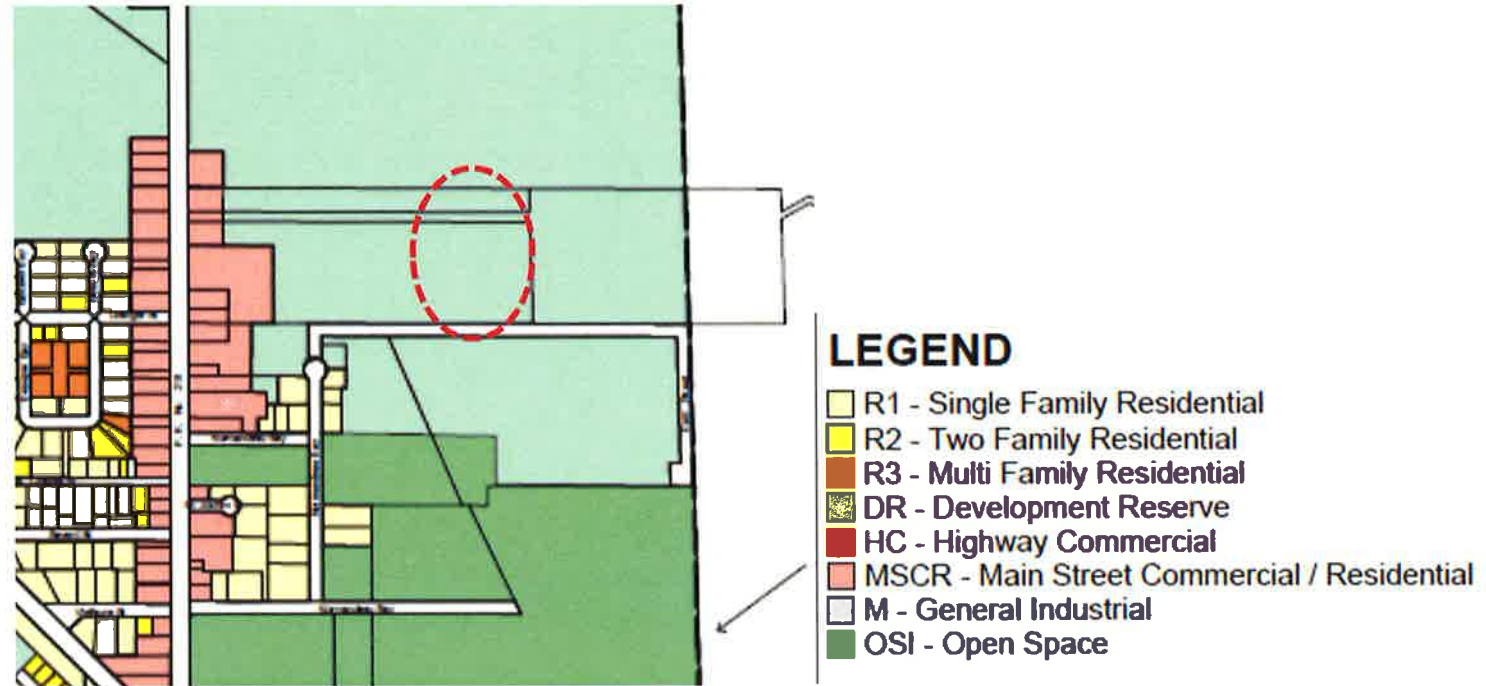

DATE: 2004/12/03  
TIME: 10:33  
POST

MANITOBA  
STATUS OF TITLE

TITLE NO: 2045539  
PAGE: 1

STATUS OF TITLE..... ACCEPTED  
ORIGINATING OFFICE..... WINNIPEG  
REGISTERING OFFICE..... WINNIPEG  
REGISTRATION DATE..... 2004/10/21  
COMPLETION DATE..... 2004/11/03

PRODUCED FOR.. DOWHAN & DOWHAN  
ADDRESS..... 61 ALBERT STREET  
WINNIPEG MB  
  
PRODUCED BY... M.DERKSEN  
LTO BOX NO.... 19

R3B1G3

LEGAL DESCRIPTION:

RURAL MUNICIPALITY OF LA BROQUERIE

IS REGISTERED OWNER SUBJECT TO SUCH ENTRIES RECORDED HEREON  
IN THE FOLLOWING DESCRIBED LAND:

PUBLIC RESERVES A AND B PLAN 43188 WLTO  
IN NE 1/4 31-6-8 EPM

ACTIVE TITLE CHARGES:

NO ACTIVE TITLE CHARGES EXIST ON THIS TITLE

ACCEPTED THIS 21ST DAY OF OCTOBER, 2004  
BY B.MCEACHERN FOR THE DISTRICT REGISTRAR OF  
THE LAND TITLES DISTRICT OF WINNIPEG.

UNCERTIFIED EXTRACT PRODUCED FROM THE LAND TITLES DATA  
STORAGE SYSTEM ON 2004/12/03 OF TITLE NUMBER 2045539 .

\*\*\*\*\* END OF STATUS OF TITLE FOR TITLE 2045539 WPG \*\*\*\*\*

DATE: 1998/02/05  
TIME: 07:51  
PORT

MANITOBA  
DUPLICATE TITLE

TITLE NO: 1545837  
PAGE: 1

STATUS OF TITLE..... ACCEPTED  
ORIGINATING OFFICE..... WINNIPEG  
REGISTERING OFFICE..... WINNIPEG  
REGISTRATION DATE..... 1998/01/29  
COMPLETION DATE..... 1998/02/04

PRODUCED FOR: DOWHAN & DOWHAN  
BY: D.THOMAS  
LTO BOX NO: 19  
CONSOLIDATION..... NO

LEGAL DESCRIPTION:

THE RURAL MUNICIPALITY OF LA BROQUERIE

IS REGISTERED OWNER SUBJECT TO SUCH ENTRIES RECORDED HEREON, IN THE FOLLOWING DESCRIBED LAND:

PUBLIC WORKS PLAN 24624 WLTO  
IN N 1/2 31-6-8 EPM

CHARGES:

NO CHARGES EXIST ON THIS TITLE

ADDRESS(ES) FOR SERVICE:

EFFECT	NAME AND ADDRESS	POSTAL CODE	FIRM NUMBER
ACTIVE	R.M. OF LA BROQUERIE BOX 130 94 PRINCIPALE ST. LA BROQUERIE MB	ROA OWO	931

ORIGINATING INSTRUMENT(S):

REGISTRATION NUMBER	TYPE	REG. DATE	CONSIDERATION	SWORN VALUE
2230514 WPG	T	1998/01/29	1.00	6900.00

PRESENTED BY: DOWHAN & DOWHAN  
FROM: H.M. THE QUEEN (MAN)  
TO: THE RURAL MUNICIPALITY OF LA BROQUERIE

FROM TITLE NUMBER(S):

1136364 WPG ALL

DUPLICATE PRODUCED FOR..... DOWHAN & DOWHAN ON 1998/02/05  
ADDRESS..... 1810-330 PORTAGE AVE.  
WINNIPEG MB  
POSTAL CODE..... R3C 0C4

ACCEPTED THIS 29TH DAY OF JANUARY, 1998  
BY D.THOMAS FOR THE DISTRICT REGISTRAR OF  
THE LAND TITLES DISTRICT OF WINNIPEG.

DUPLICATE TITLE NUMBER 1545837 PRODUCED FROM THE LAND TITLES DATA  
STORAGE SYSTEM ON 1998/02/05

  
\_\_\_\_\_  
FOR THE DISTRICT REGISTRAR

\*\*\*\*\* END OF DUPLICATE TITLE FOR TITLE 1545837 WPG \*\*\*\*\*



DATE: 2004/05/25  
TIME: 14:50  
POST

MANITOBA

TITLE NO: 1999706  
PAGE: 1

STATUS OF TITLE

STATUS OF TITLE..... ACCEPTED  
ORIGINATING OFFICE..... WINNIPEG  
REGISTERING OFFICE..... WINNIPEG  
REGISTRATION DATE..... 2004/03/10  
COMPLETION DATE..... 2004/05/20

PRODUCED FOR.. DOWHAN & DOWHAN  
ADDRESS..... 61 ALBERT STREET  
WINNIPEG MB  
  
PRODUCED BY... M.DERKSEN  
LTO BOX NO.... 19

R3B1G3

LEGAL DESCRIPTION:

THE RURAL MUNICIPALITY OF LA BROQUERIE

IS REGISTERED OWNER SUBJECT TO SUCH ENTRIES RECORDED HEREON, IN THE FOLLOWING DESCRIBED LAND:

LOT 2 PLAN 42515 WLTO  
IN W 1/2 31-6-8 EPM

ACTIVE TITLE CHARGES:

1729069 WPG ACCEPTED CAVEAT	REG'D: 1993/10/20
DESCRIPTION: WELL AGREEMENT	
FROM/BY: MARIO GEORGES EDOUARD BOILY	
TO: AGENT: DAVID KENNETH BOWMAN	
CONSIDERATION:	NOTES: SERVIENT AS TO PART

ACCEPTED THIS 10TH DAY OF MARCH, 2004  
BY J.SCOTT FOR THE DISTRICT REGISTRAR OF  
THE LAND TITLES DISTRICT OF WINNIPEG.

UNCERTIFIED EXTRACT PRODUCED FROM THE LAND TITLES DATA  
STORAGE SYSTEM ON 2004/05/25 OF TITLE NUMBER 1999706 .

\*\*\*\*\* END OF STATUS OF TITLE FOR TITLE 1999706 WPG \*\*\*\*\*

Crown Lands & Property Agency, Email Correspondence November 06, 2014

**From:** [Little, Karen \(CLPA\)](#)  
**To:** "Mario Poveda"  
**Subject:** RE: RM of La Broquerie Aerated Lagoon Expansion - Mines and Minerals  
**Date:** Thursday, November 06, 2014 9:32:59 AM

---

Good morning Mario, according to our records this date, the Dominion of Canada granted NW 31-6-8 EPM to Narcisse Pelletier in May 1886 along with the mines & minerals and sand & gravel. The Crown has no interests.

To determine current ownership of these under-rights you will need to do mineral title searches at The Winnipeg Land Titles Office.

Sincerely,  
**Karen Little**  
Supervisor of Crown Lands Registry

Crown Lands and Property Agency  
308 - 25 Tupper Street North  
Portage la Prairie MB R1N 3K1  
P 204-239-3805 F 204-239-3560  
Toll Free 1-866-210-9589  
[karen.little@gov.mb.ca](mailto:karen.little@gov.mb.ca)

*An Agency of the Manitoba Government*

The information contained in this e-mail and all attachments is confidential and is for the sole use of its intended recipient. It may not be disclosed to or used by anyone other than the addressee. If received in error, please contact the sender by return e-mail and delete this e-mail and all attachments from your system.

---

Le présent courrier électronique (courriel) et les documents qui y sont attachés peuvent contenir de l'information confidentielle; ils s'adressent exclusivement au destinataire mentionné ci-dessus et nulle autre personne ne doit en prendre connaissance ni les utiliser ou les divulguer. Si vous recevez le présent courriel par erreur, veuillez en aviser l'émetteur immédiatement par courrier électronique et le détruire avec les documents qui y sont attachés.

---

**From:** Mario Poveda [mailto:[mpoveda@jrcc.ca](mailto:mpoveda@jrcc.ca)]  
**Sent:** November-05-14 4:45 PM  
**To:** Little, Karen (CLPA)  
**Subject:** RM of La Broquerie Aerated Lagoon Expansion - Mines and Minerals

Good afternoon,

J.R. Cousin Consultants Ltd. (JRCC) is preparing an Environmental Act Proposal for the aerated lagoon expansion of the existing RM of La Broquerie lagoons. The new cells would be constructed immediately west of the existing lagoons within the NW1/4 of 31-6-8-E.

Could you please confirm the owner of the mineral rights for this property.

Thank you for your time,



Mario Poveda, E.I.T.  
Environmental Engineer-in-Training

J.R. Cousin Consultants Ltd.  
Phone: (204) 489-0474  
Fax: (204) 489-0487  
[www.jrcc.ca](http://www.jrcc.ca)

\*\*\*

The information contained in this email and any attachments is privileged, confidential and subject to copyright. It is intended solely for the use of the person(s) to whom it is addressed. If you receive this email in error, please notify the sender by return email and permanently delete it from your system. Note: We have taken precautions against viruses, but take no responsibility for loss or damage caused by any virus present.

## **Appendix B**

Manitoba Conservation and Water Stewardship, 7Q10 Flows Seine River. Email Correspondence May 28, 2014

Manitoba Conservation and Water Stewardship, Fisheries Branch. Email Correspondence December 8, 2014

Manitoba Conservation Data Centre, Species at Risk. Email Correspondence November 18, 2014

Manitoba Historic Resources Branch. Email Correspondence November 27, 2014

Manitoba Conservation and Water Stewardship, 7Q10 Flows Seine River. Email Correspondence May 28, 2014

.....  
**DATE:** 28 May 2014

**TO:** Brett McCormac, E.I.T.  
Environmental Engineer-in-Training  
J.R. Cousin Consultants

**FROM:** Sung Joon Kim, Ph.D., P. Eng.  
Senior Hydrologic Applications and Research Engineer  
Surface Water Management Section  
Water Science and Management Branch  
Manitoba Conservation and Water Stewardship

**PHONE NO.:** 204-619-2110  
**FAX NO.:** 204-945-7419

**SUBJECT:** 7Q<sub>10</sub> Flows in the Seine River near La Broquerie

---

As requested, 7Q<sub>10</sub> flows for the Seine River in NE 31-6-8-E were calculated. The 7Q<sub>10</sub> flows at the site were computed from the corresponding flows at index station 05OH007 (Seine River near Ste. Anne), using area interpolation between the drainage areas defined by the two sites.

The 7Q<sub>10</sub> flows at station 05OH007 were obtained from frequency analyses of the 7-day moving average (discrete) of recorded discharges at the station during the period of 1964-2013. No flows were recorded for the months of January, February, November and December. For the period of 1997-2009, station 05OH007 only recorded flows for the months of March, April and May. To extend station 05OH007's record for this period, flows were correlated with station 05OE001 (Rat River near Otterbourne).

The results of the 7Q<sub>10</sub> analysis and a location plan are included with this memo.

*Original Signed By*

**Sung Joon Kim, Ph.D., P. Eng.**

Enclosures:

- Design flow summary sheet
- Project Location and Project Basin Maps

Cc: Mark Lee  
Tara Wiess

**Table 1: Statistics of Monthly Averages (m<sup>3</sup>/s) for Station 05OH007**

	March	April	May	June	July	August	September	October
<b>Median</b>	0.47	4.18	3.21	2.01	0.76	0.20	0.19	0.55
<b>Lower Quartile</b>	0.18	1.33	1.64	0.84	0.28	0.10	0.10	0.20
<b>10<sup>th</sup> Percentile</b>	0.13	0.89	0.87	0.53	0.15	0.06	0.05	0.15
<b>Minimum</b>	0.06	0.49	0.44	0.13	0.02	0.01	0.00	0.02

**Table 2: 7Q<sub>10</sub> Flows at index station 05OH007 (Seine River near Ste. Anne) and at the wastewater treatment system outlet to the Seine River**

Season	7Q <sub>10</sub> Flow at 05OH007 (m <sup>3</sup> /s)	7Q <sub>10</sub> Flow at Outlet to river (m <sup>3</sup> /s)
<b>March</b>	0.3	0.2
<b>April</b>	4.8	2.9
<b>May</b>	4.8	2.9
<b>June</b>	3.3	2.0
<b>July</b>	1.1	0.7
<b>August</b>	0.6	0.4
<b>September</b>	0.7	0.4
<b>October</b>	0.8	0.5
<b>Open Water</b>	0.3	0.2
<b>Winter</b>	0.2	0.1

# SEINE RIVER NEAR LA BROQUERIE RM

## Drainage Areas

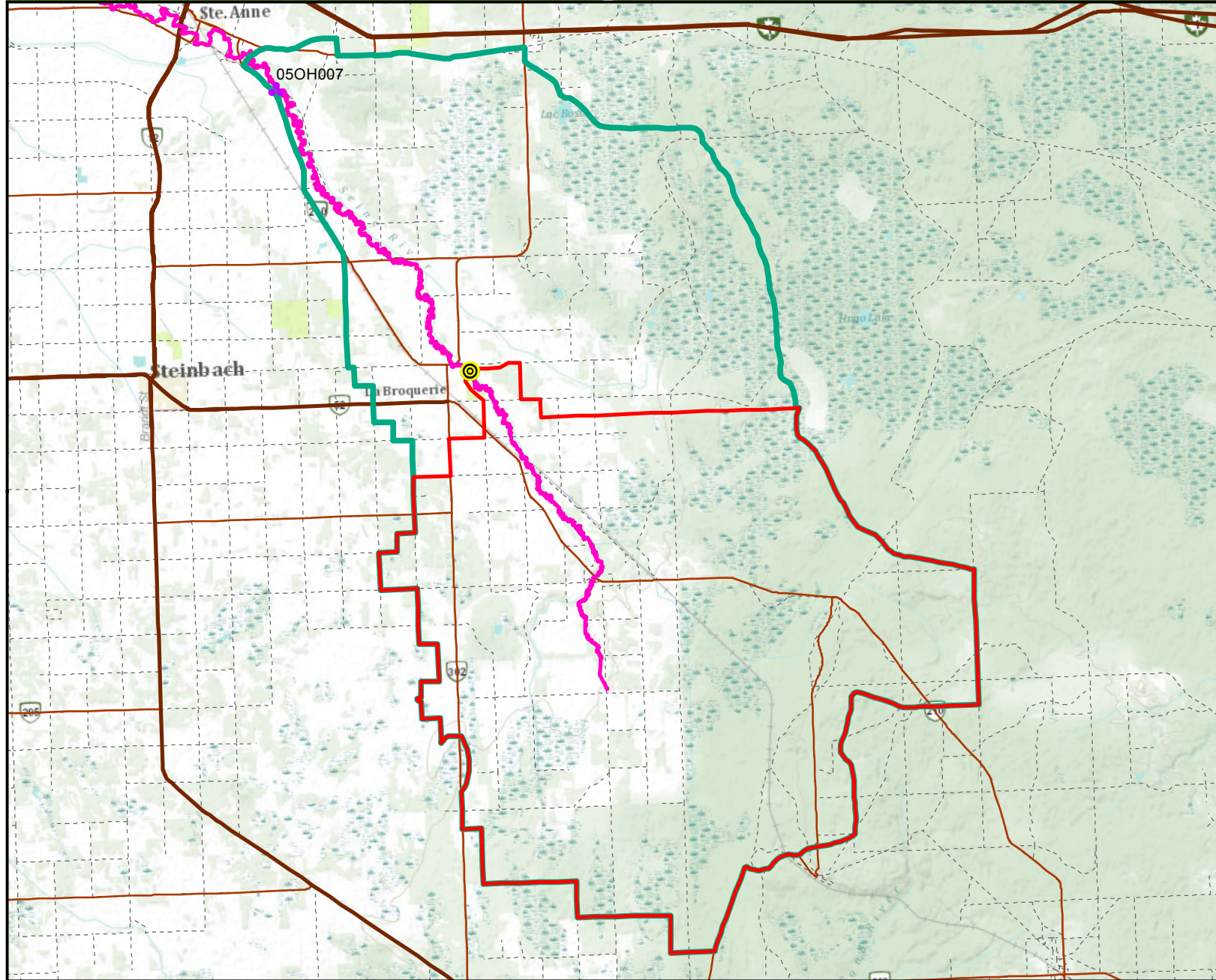

### Legend

- Station 05OH007
- Outlet to Seine River

### Drainage Areas

- Station 05OH007
- Outlet to Seine River
- Seine River
- Provincial Highway
- Provincial Road
- Municipal Roads

Drainage Areas		
	Area (km <sup>2</sup> )	Acres
05OH007	701	173,296
Outlet	420	103,687

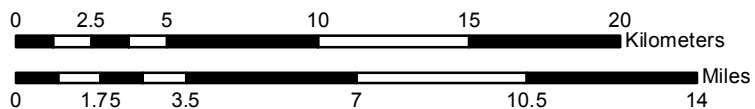

1:250,000

Datum: GCS NAD 1983  
 Projection: UTM Zone 14 N  
 Base Map: ESRI World Topo Map  
 Date Printed: May 14, 2014



Manitoba Conservation and Water Stewardship, Fisheries Branch. Email Correspondence December 8, 2014

**From:** [Long, Jeff \(CWS\)](#)  
**To:** [Mario Poveda](#); [Kroeker, Derek \(CWS\)](#)  
**Cc:** [Janusz, Laureen R \(CWS\)](#)  
**Subject:** RE: RM of La Broquerie Aerated Lagoon Expansion - Fisheries Info  
**Date:** Friday, December 05, 2014 9:15:00 PM

---

Hi Mario,

Thanks for the information. One of the concerns effluent may have for small systems is a higher than background biological demand that may affect dissolved oxygen levels in the receiving waters (though presumably effluent flows are low compared to river flows and this becomes only a theoretical concern). There are also potential ecotoxicological effects, depending on the nature of the effluent. However, if the water Quality guidelines are observed, then as Laureen has indicated, these projects have generally been relatively benign to fisheries interests. We appreciate you contacting our branch to learn of any possible concerns we may have.

Regards,

Jeff Long, Ph.D. |Manager - Fisheries Science and Fish Culture |

MB Fisheries Branch - Conservation and Water Stewardship, |200 Saulteaux Cres.  
Winnipeg, Manitoba |R3J 3W3 email: [jeff.long@gov.mb.ca](mailto:jeff.long@gov.mb.ca) |Tel. 204.945.7792  
Cell. 204.232.6870 |Fax. 204.948.2308

---

**From:** Mario Poveda [<mailto:mpoveda@jrcc.ca>]  
**Sent:** December-05-14 4:24 PM  
**To:** Kroeker, Derek (CWS)  
**Cc:** Long, Jeff (CWS); Janusz, Laureen R (CWS)  
**Subject:** RE: RM of La Broquerie Aerated Lagoon Expansion - Fisheries Info

Hi Derek,

The lagoon expansion will not change the length of the drainage ditch. Currently, the length of the drainage between the lagoon and the river is 255 m. Please find attached an image of the area.

Thank you for your assistance,

Mario Poveda, E.I.T.  
Environmental Engineer-in-Training

J.R. Cousin Consultants Ltd.  
Phone: (204) 489-0474  
Fax: (204) 489-0487  
[www.jrcc.ca](http://www.jrcc.ca)

\*\*\*



The information contained in this email and any attachments is privileged, confidential and subject to copyright. It is intended solely for the use of the person(s) to whom it is addressed. If you receive this email in error, please notify the sender by return email and permanently delete it from your system. Note: We have taken precautions against viruses, but take no responsibility for loss or damage caused by any virus present.

---

**From:** Kroeker, Derek (CWS) [<mailto:Derek.Kroeker@gov.mb.ca>]  
**Sent:** Thursday, December 04, 2014 11:30 AM  
**To:** 'Mario Poveda'  
**Cc:** Long, Jeff (CWS); Janusz, Laureen R (CWS)  
**Subject:** RE: RM of La Broquerie Aerated Lagoon Expansion - Fisheries Info

Hi Mario,

Two questions:

What is the current length of the drainage ditch from the lagoon to the Seine river?  
Does the lagoon expansion proposal change the length of the drainage ditch between the lagoon and the Seine River? (If so, please provide details)

If you have any pictures or maps of the current drainage system, please attach them to your response.

Thank you.

Derek

Derek Kroeker  
A/Fisheries Manager - Eastern Region  
Fisheries Biologist - Central Region  
Conservation and Water Stewardship  
Fisheries Branch  
Box 4000  
Lac du Bonnet, MB R0E 1A0  
Ph: (204) 345-1450  
Fax: (204) 345-1440  
Cell: (204) 345-3068

---

**From:** Janusz, Laureen R (CWS)  
**Sent:** December-04-14 11:21 AM  
**To:** 'Mario Poveda'  
**Cc:** Kroeker, Derek (CWS); Long, Jeff (CWS)  
**Subject:** RM of La Broquerie Aerated Lagoon Expansion - Fisheries Info

Hi Mario,

My apologies for the delay. The Seine and Red rivers are fish bearing rivers. If this proposed project will improve effluent quality so that it meets or exceeds Manitoba Standards, Objectives and Guidelines and effluent is being discharged through an existing drainage ditch then it is likely that any potential fisheries concerns will be addressed. I have cc'd the Acting Eastern Regional Fisheries Manager in case he has any comments or concerns. Thank you.

Laureen Janusz  
Fisheries Science and Fish Culture Section  
Fisheries Branch  
Conservation and Water Stewardship  
Phone: 204 945-7789  
Cell: 204 793-1154  
Email: [Laureen.Janusz@gov.mb.ca](mailto:Laureen.Janusz@gov.mb.ca)

---

**From:** Mario Poveda [<mailto:mpoveda@jrcc.ca>]  
**Sent:** December-03-14 4:37 PM  
**To:** Janusz, Laureen R (CWS)  
**Subject:** FW: RM of La Broquerie Aerated Lagoon Expansion - Fisheries Info

Good afternoon Ms. Janusz.

I sent you the email below on November 05 regarding the Environmental Act Proposal for the construction of the aerated lagoon expansion of the existing RM of La Broquerie lagoons.

Could you please get back to me with any comments or concerns the Fisheries Branch may have with the proposed project?

Thank you,

Mario Poveda, E.I.T.  
Environmental Engineer-in-Training

J.R. Cousin Consultants Ltd.  
Phone: (204) 489-0474  
Fax: (204) 489-0487  
[www.jrcc.ca](http://www.jrcc.ca)

\*\*\*

The information contained in this email and any attachments is privileged, confidential and subject to copyright. It is intended solely for the use of the person(s) to whom it is addressed. If you receive this email in error, please notify the sender by return email and permanently delete it from your system. Note: We have taken precautions against viruses, but take no responsibility for loss or damage caused by any virus present.

---

**From:** Mario Poveda [<mailto:mpoveda@jrcc.ca>]  
**Sent:** Wednesday, November 05, 2014 4:48 PM

**To:** 'Laureen.Janusz@gov.mb.ca'

**Cc:** Brett McCormac ([bmccormac@jrcc.ca](mailto:bmccormac@jrcc.ca))

**Subject:** RM of La Broquerie Aerated Lagoon Expansion - Fisheries Info

Good afternoon,

J.R. Cousin Consultants Ltd. (JRCC) is preparing an Environmental Act Proposal for the aerated lagoon expansion of the existing RM of La Broquerie lagoons. The new cells would be constructed immediately west of the existing lagoons within the NW1/4 of 31-6-8-E.

The aerated lagoon will have highly treated effluent with phosphorus reduction and UV disinfection. The drainage route from the expanded lagoon will follow the existing licensed drainage route. The lagoon discharges through a short drainage ditch into the Seine River, which eventually flows into the Red River.

Could you please respond with any comments or concerns you have with the proposed project.

Mario Poveda, E.I.T.

Environmental Engineer-in-Training

J.R. Cousin Consultants Ltd.

Phone: (204) 489-0474

Fax: (204) 489-0487

[www.jrcc.ca](http://www.jrcc.ca)

\*\*\*

The information contained in this email and any attachments is privileged, confidential and subject to copyright. It is intended solely for the use of the person(s) to whom it is addressed. If you receive this email in error, please notify the sender by return email and permanently delete it from your system. Note: We have taken precautions against viruses, but take no responsibility for loss or damage caused by any virus present.

Manitoba Conservation Data Centre, Species at Risk. Email Correspondence November 18, 2014

**From:** [Friesen, Chris \(CWS\)](#)  
**To:** "Mario Poveda"  
**Subject:** RE: RM of La Broquerie Aerated Lagoon Expansion  
**Date:** Tuesday, November 18, 2014 11:02:53 AM

---

Mario

Thank you for your information request. I completed a search of the Manitoba Conservation Data Centre's rare species database and found no occurrences at this time for your area of interest.

The information provided in this letter is based on existing data known to the Manitoba Conservation Data Centre at the time of the request. These data are dependent on the research and observations of CDC staff and others who have shared their data, and reflect our current state of knowledge. **An absence of data in any particular geographic area does not necessarily mean that species or ecological communities of concern are not present;** in many areas, comprehensive surveys have never been completed. Therefore, this information should be regarded neither as a final statement on the occurrence of any species of concern, nor as a substitute for on-site surveys for species as part of environmental assessments.

Because the Manitoba CDC's Biotics database is continually updated and because information requests are evaluated by type of action, any given response is only appropriate for its respective request. Please contact the Manitoba CDC for an update on this natural heritage information if more than six months pass before it is utilized.

Third party requests for products wholly or partially derived from Biotics must be approved by the Manitoba CDC before information is released. Once approved, the primary user will identify the Manitoba CDC as data contributors on any map or publication using Biotics data, as follows as: Data developed by the Manitoba Conservation Data Centre; Wildlife Branch, Manitoba Conservation and Water Stewardship.

**This letter is for information purposes only - it does not constitute consent or approval of the proposed project or activity, nor does it negate the need for any permits or approvals required by the Province of Manitoba.**

We would be interested in receiving a copy of the results of any field surveys that you may undertake, to update our database with the most current knowledge of the area.

If you have any questions or require further information please contact me directly at (204) 945-7747.

Chris Friesen  
Biodiversity Information Manager  
Manitoba Conservation Data Centre  
204-945-7747  
[chris.friesen@gov.mb.ca](mailto:chris.friesen@gov.mb.ca)  
<http://www.gov.mb.ca/conservation/cdc/>

---

**From:** Mario Poveda [<mailto:mpoveda@jrcc.ca>]  
**Sent:** November-12-14 3:55 PM  
**To:** Friesen, Chris (CWS)  
**Subject:** FW: RM of La Broquerie Aerated Lagoon Expansion

Good afternoon,

The email below was sent last week addressed to Ms. Nicole Firlotte but I missed to include your

address. I noticed in previous communications that you have also helped us with these matters, so I wanted to forward the email just in case.

Thank you for your time and assistance,

Mario Poveda, E.I.T.  
Environmental Engineer-in-Training

J.R. Cousin Consultants Ltd.  
Phone: (204) 489-0474  
Fax: (204) 489-0487  
[www.jrcc.ca](http://www.jrcc.ca)

\*\*\*

The information contained in this email and any attachments is privileged, confidential and subject to copyright. It is intended solely for the use of the person(s) to whom it is addressed. If you receive this email in error, please notify the sender by return email and permanently delete it from your system. Note: We have taken precautions against viruses, but take no responsibility for loss or damage caused by any virus present.

---

**From:** Mario Poveda [<mailto:mpoveda@jrcc.ca>]  
**Sent:** Wednesday, November 05, 2014 4:01 PM  
**To:** 'Nicole.Firlotte@gov.mb.ca'  
**Subject:** RM of La Broquerie Aerated Lagoon Expansion

Good afternoon,

J.R. Cousin Consultants Ltd. (JRCC) is preparing an Environmental Act Proposal for the aerated lagoon expansion of the existing RM of La Broquerie lagoons. The new cells would be constructed immediately west of the existing lagoons within the NW1/4 of 31-6-8-E.

Could you please confirm there are no 'species at risk' known to exist on the property.

Thank you for your time,

Mario Poveda, E.I.T.  
Environmental Engineer-in-Training

J.R. Cousin Consultants Ltd.  
Phone: (204) 489-0474  
Fax: (204) 489-0487  
[www.jrcc.ca](http://www.jrcc.ca)

\*\*\*

The information contained in this email and any attachments is privileged, confidential and subject to copyright. It is intended solely for the use of the person(s) to whom it is addressed. If you receive this email in error, please notify the sender by return email and permanently delete it from your system. Note: We have taken precautions against viruses, but take no responsibility for loss or damage caused by any virus present.

Manitoba Historic Resources Branch. Email Correspondence November 27, 2014



DATE: November 27, 2014

TO: Mario Poveda  
E.I.T  
J.R. Cousin Consultants Ltd.  
Phone: (204) 489-0474  
mpoveda@jrcc.ca

FROM: Christina Nesbitt  
Impact Assessment  
Archaeologist  
Historic Resources Branch  
Main Floor 213 Notre Dame  
Avenue  
Winnipeg MB  
R3B 1N3

PHONE NO: Christina.Nesbitt@gov.mb.ca  
(204) 945-8145

SUBJECT: Aerated Lagoon Expansion  
RM of La Broquerie  
NW 1/4 31-6-8 E

HRB FILE: AAS-14-8441

Further to your memo regarding the proposed lagoon expansion immediately west of the existing lagoon in La Broquerie (Planned Area), The Historic Resources Branch (HRB) has examined the applicable areas proposed for development in conjunction with the Branch records for areas of potential concern and can advise you that there are no previously recorded heritage site(s) located within the Planned Area and therefore HRB has no concerns with the Project at this time.

However, please be advised that if any heritage resources are encountered in association with the Planned Area during development, HRB may require that an acceptable heritage resource management strategy be implemented by the developer to mitigate the affects of development on the heritage resources.

If you have any questions or comments, please feel free to contact the undersigned at the above noted address, phone number, or e-mail.

Christina Nesbitt

## **Appendix C**

Title Plan

Plan 1: Test Hole Locations and Contour Lines

Plan 2: Proposed Aerated Lagoon with 300 m Setback

Plan 3: Proposed Aerated Lagoon Expansion

Plan 4: Dike Cross Section and Fence Details

Plan 5: Silt Fence and Concrete Spillway Details

Plan 6: Preliminary Building Layout

# RM OF LA BROQUERIE

## WASTEWATER TREATMENT LAGOON EXPANSION

### ENVIRONMENT ACT PROPOSAL

**PRELIMINARY**  
NOT FOR CONSTRUCTION

REDUCED DRAWING  
DO NOT SCALE

#### PLAN INDEX

##### LAGOON

- PLAN L1. TEST HOLE LOCATIONS AND CONTOUR LINES
- PLAN L2. PROPOSED AERATED LAGOON WITH 300m SETBACK
- PLAN L3. PROPOSED AERATED LAGOON EXPANSION
- PLAN L4. DIKE CROSS SECTION AND FENCE DETAILS
- PLAN L5. SILT FENCE AND CONCRETE SPILLWAY DETAILS
- PLAN L6. PRELIMINARY BUILDING LAYOUT

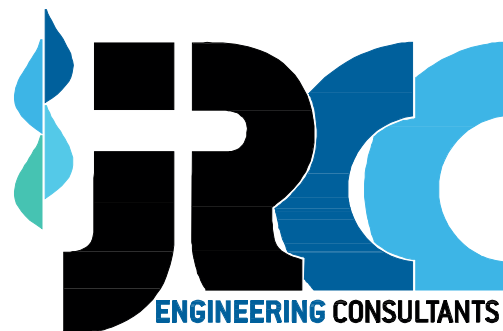

JR Cousin Consultants Ltd.

91A Scurfield Blvd. Winnipeg MB R3Y 1G4

p. (204) 489-0474

f. (204) 489-0487

[www.jrcc.ca](http://www.jrcc.ca)

ENGINEERING EXCELLENCE SINCE 1981





31-06-08-E



Date: 18, 2014 - 1:00pm P.M. La Broquerie, MB. Design and Drafting Co. Drawing: J.R. Cousin Ltd. Title: Test Holes and Contour Lines

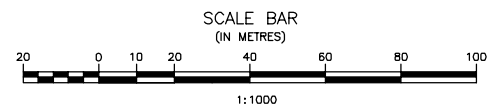

No.	REVISIONS	DATE	INITIALS

B.M. EL.

LOCATIONS OF UNDERGROUND STRUCTURES/UTILITIES AS SHOWN ARE BASED ON AVAILABLE INFORMATION BUT NO GUARANTEE IS GIVEN OR IMPLIED THAT ALL EXISTING UNDERGROUND STRUCTURES/UTILITIES ARE SHOWN OR THAT THE GIVEN LOCATIONS ARE EXACT. CONFIRMATION OF EXISTENCE AND EXACT LOCATION OF ALL UNDERGROUND STRUCTURES/UTILITIES MUST BE OBTAINED FROM THE APPROPRIATE AUTHORITY/OWNER, BY THE CONTRACTOR, BEFORE PROCEEDING WITH CONSTRUCTION.

**APECM**  
 Certificate of Authorization  
**J.R. Cousin Consultants Ltd.**  
 No. 234 Date: 14/12/18



**JR Cousin Consultants Ltd.**  
 91A Scurfield Blvd. Winnipeg MB R3Y1G4  
 p. (204) 489-0474  
 f. (204) 489-0487  
 www.jrcc.ca  
 ENGINEERING EXCELLENCE SINCE 1981

CODE: L-169.75	PROJECT: RM OF LA BROQUERIE AERATED LAGOON
DESIGNED BY: BM	TITLE: TEST HOLE LOCATIONS AND CONTOUR LINES
DRAWN BY: MP	SCALE: 1:1000
REVIEWED BY: JC	DATE: 14/12/15
	PLAN: L1
	SHEET: 1 of 6



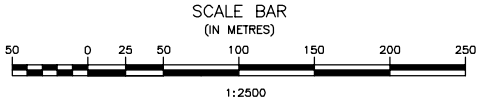

No.	REVISIONS	DATE	INITIALS

B.M. EL.

LOCATIONS OF UNDERGROUND STRUCTURES/UTILITIES AS SHOWN ARE BASED ON AVAILABLE INFORMATION BUT NO GUARANTEE IS GIVEN OR IMPLIED THAT ALL EXISTING UNDERGROUND STRUCTURES/UTILITIES ARE SHOWN OR THAT THE GIVEN LOCATIONS ARE EXACT. CONFIRMATION OF EXISTENCE AND EXACT LOCATION OF ALL UNDERGROUND STRUCTURES/UTILITIES MUST BE OBTAINED FROM THE APPROPRIATE AUTHORITY/OWNER, BY THE CONTRACTOR, BEFORE PROCEEDING WITH CONSTRUCTION.

**APEGM**  
 Certificate of Authorization  
**J.R. Cousin Consultants Ltd.**  
 No. 234 Date: 14/12/18

ENGINEER'S SEAL  
 PROVINCE OF MANITOBA  
**G. R. COUSIN**  
 REGISTERED PROFESSIONAL ENGINEER  
 14/12/18

**JR** **ENGINEERING CONSULTANTS**  
**JR Cousin Consultants Ltd.**  
 91A Scurfield Blvd. Winnipeg MB R3Y1G4  
 p. (204) 489-0474  
 f. (204) 489-0487  
 www.jrcc.ca  
 ENGINEERING EXCELLENCE SINCE 1981

CODE:	L-169.75	PROJECT:	RM OF LA BROOQUERIE AERATED LAGOON
DESIGNED BY:	BM	TITLE:	PROPOSED AERATED LAGOON WITH 300m SETBACK
DRAWN BY:	MP	SCALE:	1:2500
REVIEWED BY:	JC	DATE:	14/12/15
		PLAN:	L2
		SHEET:	2 of 6

Date: 18. 2015 - 1:30pm P.M. La Broquerie, MB - Proposed Aeration Plant - Proposed Aeration Station with existing contour mapping.



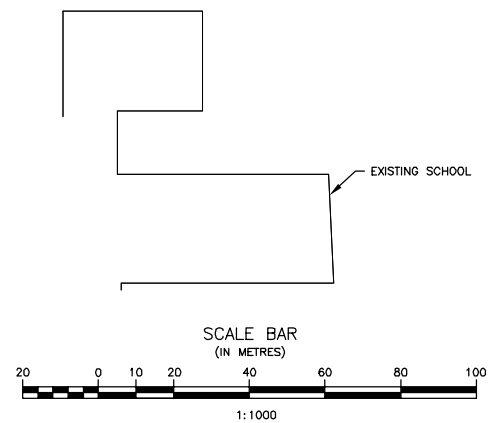
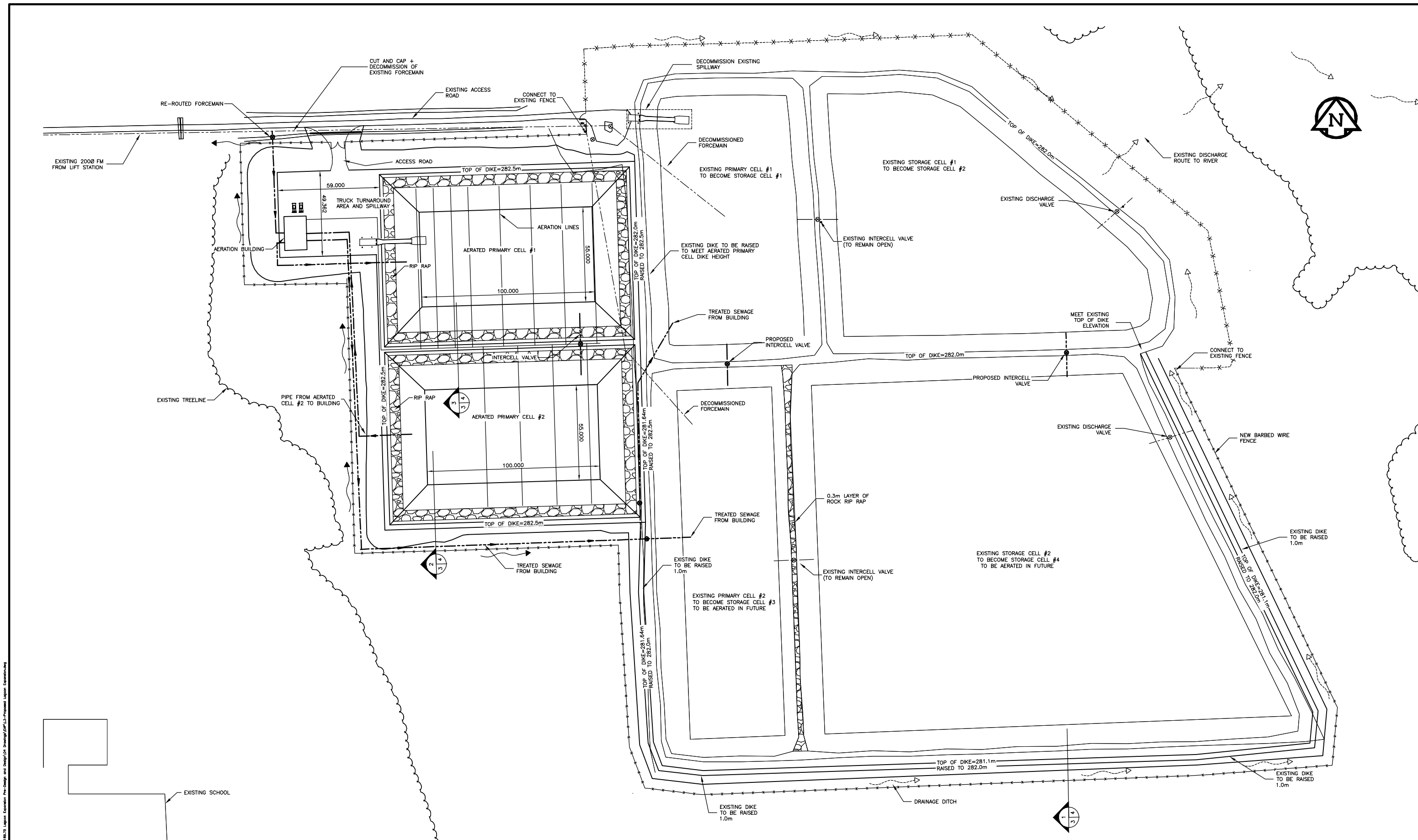

No.	REVISIONS	DATE	INITIALS

B.M. EL.

LOCATIONS OF UNDERGROUND STRUCTURES/UTILITIES AS SHOWN ARE BASED ON AVAILABLE INFORMATION BUT NO GUARANTEE IS GIVEN OR IMPLIED THAT ALL EXISTING UNDERGROUND STRUCTURES/UTILITIES ARE SHOWN OR THAT THE GIVEN LOCATIONS ARE EXACT. CONFIRMATION OF EXISTENCE AND EXACT LOCATION OF ALL UNDERGROUND STRUCTURES/UTILITIES MUST BE OBTAINED FROM THE APPROPRIATE AUTHORITY/OWNER, BY THE CONTRACTOR, BEFORE PROCEEDING WITH CONSTRUCTION.

**APEGM**  
 Certificate of Authorization  
**J.R. Cousin Consultants Ltd.**  
 No. 234 Date: 14/12/18

ENGINEER'S SEAL  
 PROVINCE OF MANITOBA  
**G. R. COUSIN**  
 REGISTERED PROFESSIONAL ENGINEER  
 14/12/18

**JR** ENGINEERING CONSULTANTS  
**JR Cousin Consultants Ltd.**  
 91A Scurfield Blvd. Winnipeg MB R3Y1G4  
 p. (204) 489-0474  
 f. (204) 489-0487  
 www.jrcc.ca  
 ENGINEERING EXCELLENCE SINCE 1981

CODE: L-169.75	PROJECT: RM OF LA BROQUERIE AERATED LAGOON
DESIGNED BY: BM	TITLE: PROPOSED AERATED LAGOON EXPANSION
DRAWN BY: MP	SCALE: 1:1000
REVIEWED BY: JC	DATE: 14/12/15
	PLAN: L3
	SHEET: 3 of 6

Dec. 16, 2014 - 1:28pm P:\1501\1501 - La Broquerie\1501 - Proposed Lagoon Expansion\1501 - Proposed Lagoon Expansion.dwg  
 User: JRC  
 Plot Date: 14/12/15 1:28pm  
 Plot Scale: 1:1000  
 Plot Size: 11.00 x 17.00  
 Plot Path: P:\1501\1501 - La Broquerie\1501 - Proposed Lagoon Expansion\1501 - Proposed Lagoon Expansion.dwg

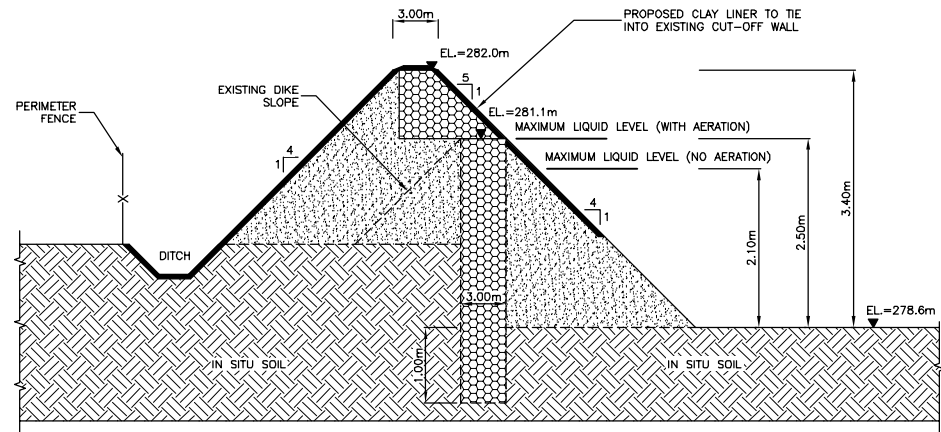

1  
3 4  
SOUTH PERIMETER DIKE  
TO BE RAISED 1.0m  
VERTICAL=1:50  
HORIZONTAL=1:250

- LEGEND**
- TOPSOIL
  - EXCAVATED AND COMPACTED SOILS SUITABLE FOR DIKE CONSTRUCTION
  - EXCAVATED AND COMPACTED MEDIUM TO HIGH PLASTIC CLAY
  - INSITU INORGANIC MEDIUM TO HIGH PLASTIC CLAY
  - ROCK RIP RAP
  - SILTY SANDS, SAND-SILT MIXTURES

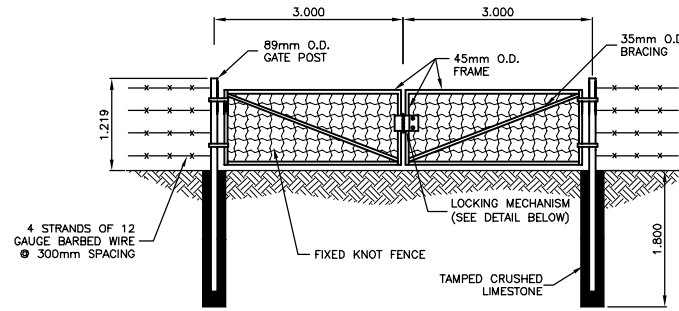

4  
4  
GATE DETAIL  
Scale = 1:50

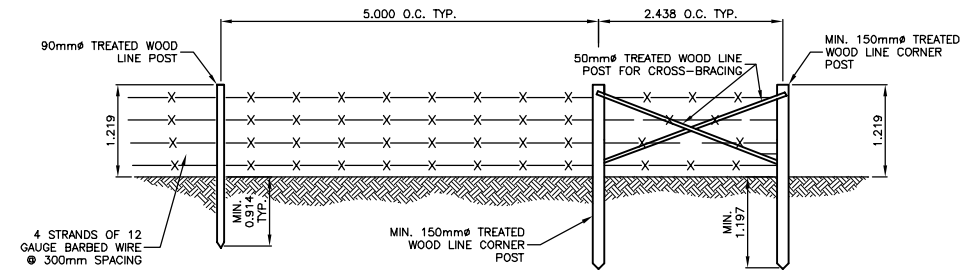

NOTE:  
- PROVIDE CROSS BRACING AT CORNER POSTS IN BOTH DIRECTIONS.  
- SHOWN DIAMETER REFERS TO SMALLEST END OF POST.

5  
4  
FENCE DETAIL  
SCALE = 1:50

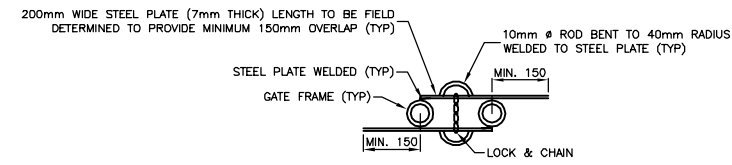

6  
4  
LOCK DETAIL  
SCALE = 1:10

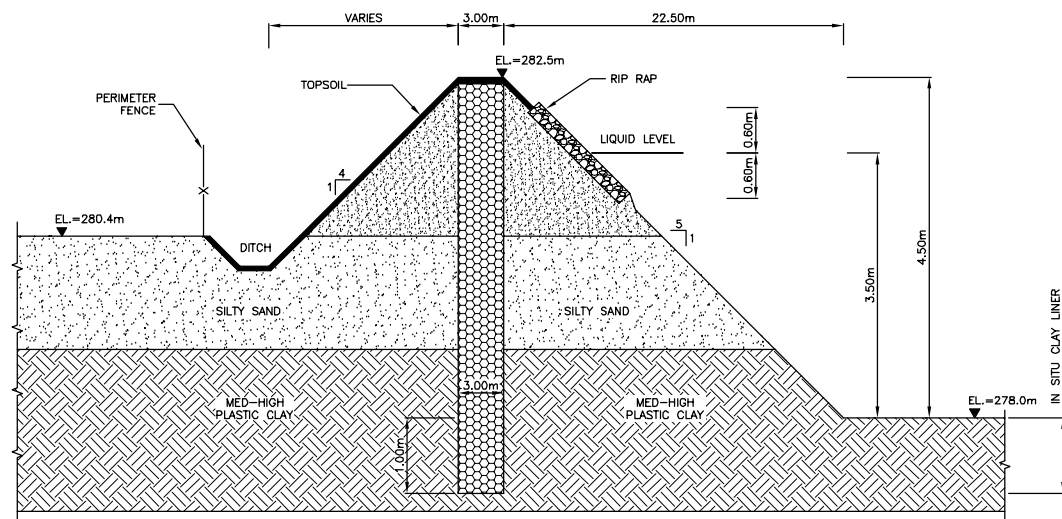

2  
3 4  
PERIMETER DIKE OF NEW AERATED  
PRIMARY CELL  
VERTICAL=1:50  
HORIZONTAL=1:250

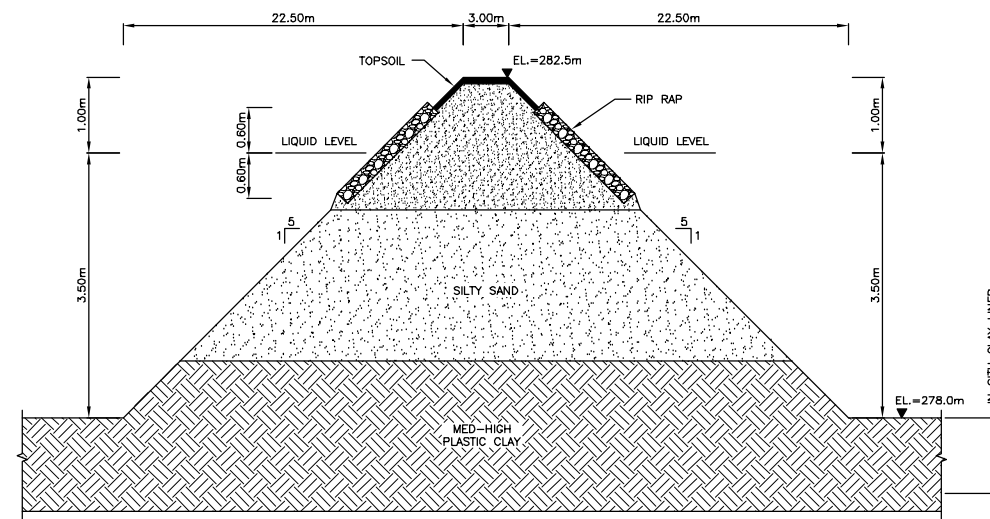

3  
3 4  
INTERCELL DIKE OF NEW  
AERATED PRIMARY CELL  
VERTICAL=1:50  
HORIZONTAL=1:250

No.	REVISIONS	DATE	INITIALS

B.M. EL.  
LOCATIONS OF UNDERGROUND STRUCTURES/UTILITIES AS SHOWN ARE BASED ON AVAILABLE INFORMATION BUT NO GUARANTEE IS GIVEN OR IMPLIED THAT ALL EXISTING UNDERGROUND STRUCTURES/UTILITIES ARE SHOWN OR THAT THE GIVEN LOCATIONS ARE EXACT. CONFIRMATION OF EXISTENCE AND EXACT LOCATION OF ALL UNDERGROUND STRUCTURES/UTILITIES MUST BE OBTAINED FROM THE APPROPRIATE AUTHORITY/OWNER, BY THE CONTRACTOR, BEFORE PROCEEDING WITH CONSTRUCTION.

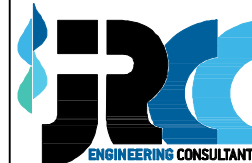
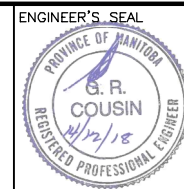
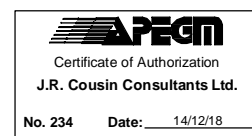

JR Cousin Consultants Ltd.  
91A Scurfield Blvd. Winnipeg MB R3Y1G4  
p. (204) 489-0474  
f. (204) 489-0487  
www.jrcc.ca

CODE:	L-169.75
DESIGNED BY:	BM
DRAWN BY:	MP
REVIEWED BY:	JC

PROJECT:	RM OF LA BROQUERIE AERATED LAGOON
TITLE:	DIKE CROSS SECTION AND FENCE DETAILS
SCALE:	AS NOTED
DATE:	14/12/15
PLAN:	L4
SHEET:	4 of 6

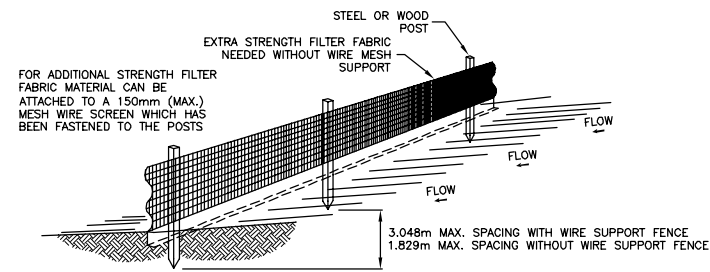

- NOTES:
1. THE HEIGHT OF A SILT FENCE SHALL NOT EXCEED 914mm.
  2. THE FILTER FABRIC SHALL BE PURCHASED IN A CONTINUOUS ROLL CUT TO THE LENGTH OF THE BARRIER TO AVOID THE USE OF JOINTS.
  3. POSTS SHALL BE SPACED A MAXIMUM OF 3.048m APART AT THE BARRIER LOCATION AND DRIVEN SECURELY INTO THE GROUND A MINIMUM OF 300mm. WHEN EXTRA STRENGTH FABRIC IS USED WITHOUT THE WIRE SUPPORT FENCE, POST SPACING SHALL NOT EXCEED 1.829m.
  4. A TRENCH SHALL BE EXCAVATED APPROXIMATELY 100mm WIDE AND 100mm DEEP ALONG THE LINE OF POSTS AND UPSLOPE FROM THE BARRIER.
  5. WHEN STANDARD STRENGTH FILTER FABRIC IS USED, A WIRE MESH SUPPORT FENCE SHALL BE FASTENED SECURELY TO THE UPSLOPE SIDE OF THE POSTS USING HEAVY DUTY WIRE STAPLES AT LEAST 25mm LONG, TIE WIRES, OR HOG RINGS. THE WIRE SHALL EXTEND INTO THE TRENCH A MINIMUM OF 50mm AND SHALL NOT EXTEND MORE THAN 914mm ABOVE THE ORIGINAL GROUND SURFACE.
  6. THE STANDARD STRENGTH FILTER FABRIC SHALL BE STAPLED OR WIRED TO THE FENCE, AND 200mm OF THE FABRIC SHALL BE EXTENDED INTO THE TRENCH. THE FABRIC SHALL NOT EXTEND MORE THAN 914mm ABOVE THE ORIGINAL GROUND SURFACE.
  7. THE TRENCH SHALL BE BACKFILLED AND THE SOIL COMPACTED OVER THE FILTER FABRIC.
  8. SILT FENCING TO BE POLYPROPYLENE SYNTHETIC FIBRE WITH ULTRAVIOLET STABILIZERS, AMOCO 1198 OR APPROVED EQUAL.
  9. WOOD POSTS TO BE 38mm X 89mm (2" X 4"), POINTED AT ONE END AND FABRICATED.
  10. INSTALL ALL SUPPORTING POSTS ON THE DOWN SLOPE SIDE OF THE FENCING.
  11. MAINTAIN SILT FENCE THROUGHOUT CONSTRUCTION AND UNTIL REVEGETATION OCCURS.

1 SILT FENCE DETAIL  
SCALE = NTS

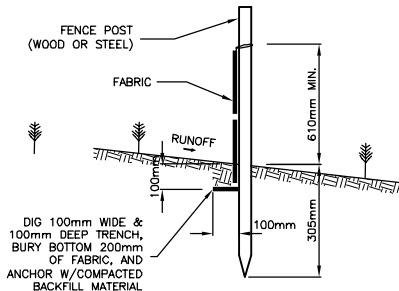

2 SILT FENCE SECTION  
SCALE = NTS

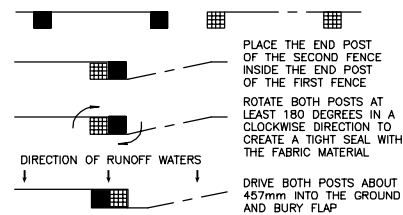

3 ATTACHING TWO SILT FENCES  
SCALE = NTS

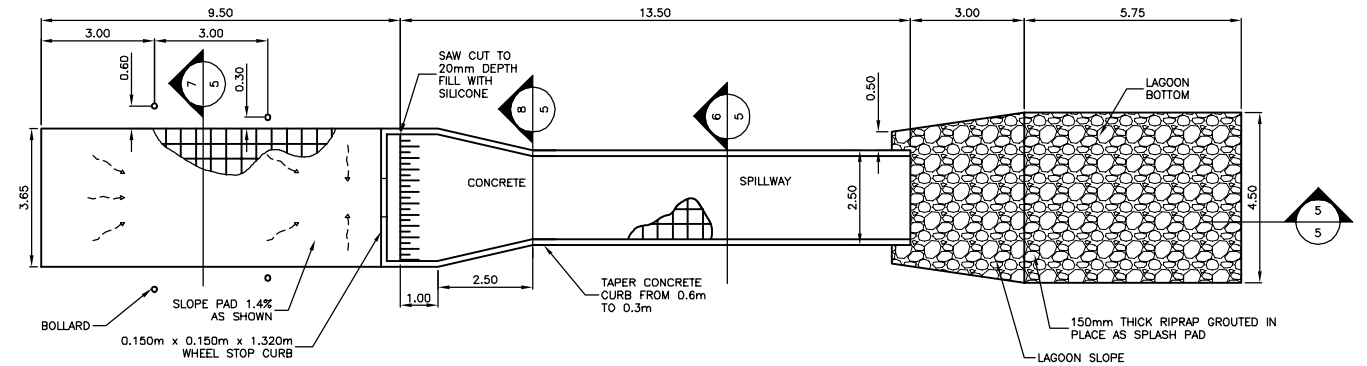

4 SPILLWAY PLAN VIEW  
SCALE = 1:100

- RIPRAP
- CONCRETE
- A-BASE
- C-BASE

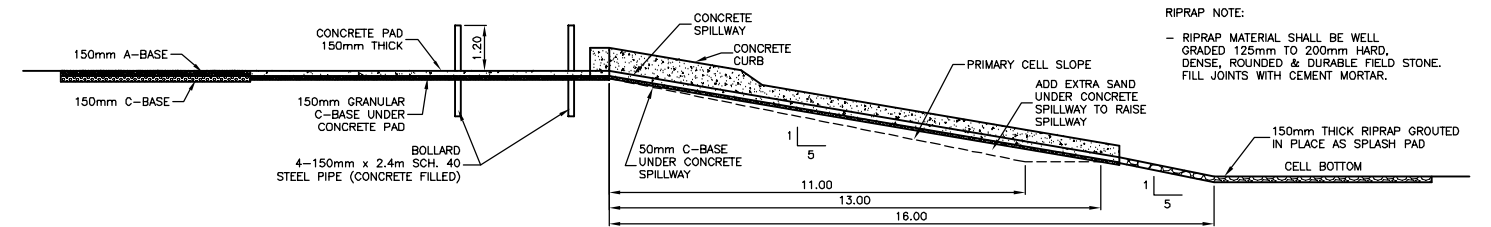

5 SPILLWAY SECTION  
SCALE = 1:100

RIPRAP NOTE:  
- RIPRAP MATERIAL SHALL BE WELL GRADED 125mm TO 200mm HARD, DENSE, ROUNDED & DURABLE FIELD STONE. FILL JOINTS WITH CEMENT MORTAR.

CONCRETE NOTE:  
CONCRETE SHALL BE:  
- TYPE GU PORTLAND CEMENT MINIMUM 28 DAY COMPRESSION OF 20 MPa  
- 5-7% AIR CONTENT  
- MAXIMUM AGGREGATE SIZE OF 20mm  
- MAXIMUM SLUMP OF 100mm

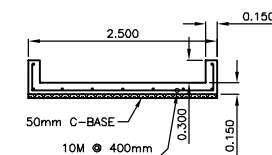

6 CONCRETE SPILLWAY SECTION  
SCALE = 1:50

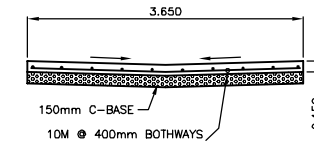

7 CONCRETE PAD SECTION  
SCALE = 1:50

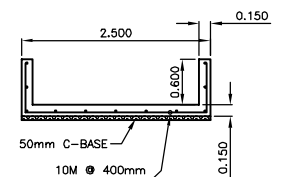

8 CONCRETE SPILLWAY SECTION  
SCALE = 1:50

No.	REVISIONS	DATE	INITIALS

B.M. EL.  
LOCATIONS OF UNDERGROUND STRUCTURES/UTILITIES AS SHOWN ARE BASED ON AVAILABLE INFORMATION BUT NO GUARANTEE IS GIVEN OR IMPLIED THAT ALL EXISTING UNDERGROUND STRUCTURES/UTILITIES ARE SHOWN OR THAT THE GIVEN LOCATIONS ARE EXACT. CONFIRMATION OF EXISTENCE AND EXACT LOCATION OF ALL UNDERGROUND STRUCTURES/UTILITIES MUST BE OBTAINED FROM THE APPROPRIATE AUTHORITY/OWNER, BY THE CONTRACTOR, BEFORE PROCEEDING WITH CONSTRUCTION.

**APEGM**  
Certificate of Authorization  
**J.R. Cousin Consultants Ltd.**  
No. 234 Date: 14/12/18

ENGINEER'S SEAL  
PROVINCE OF MANITOBA  
**G. R. COUSIN**  
REGISTERED PROFESSIONAL ENGINEER

**JR**  
ENGINEERING CONSULTANTS  
ENGINEERING EXCELLENCE SINCE 1981

**JR Cousin Consultants Ltd.**  
91A Scurfield Blvd. Winnipeg MB R3Y1G4  
p. (204) 489-0474  
f. (204) 489-0487  
www.jrcc.ca

CODE: L-167.75  
DESIGNED BY: BM  
DRAWN BY: MP  
REVIEWED BY: JC

PROJECT: RM OF LA BROQUERIE AERATED LAGOON  
TITLE: SILT FENCE AND CONCRETE SPILLWAY DETAILS

SCALE: AS NOTED DATE: 14/12/15 PLAN: L5 SHEET: 5 of 6



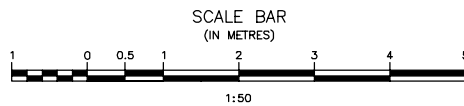
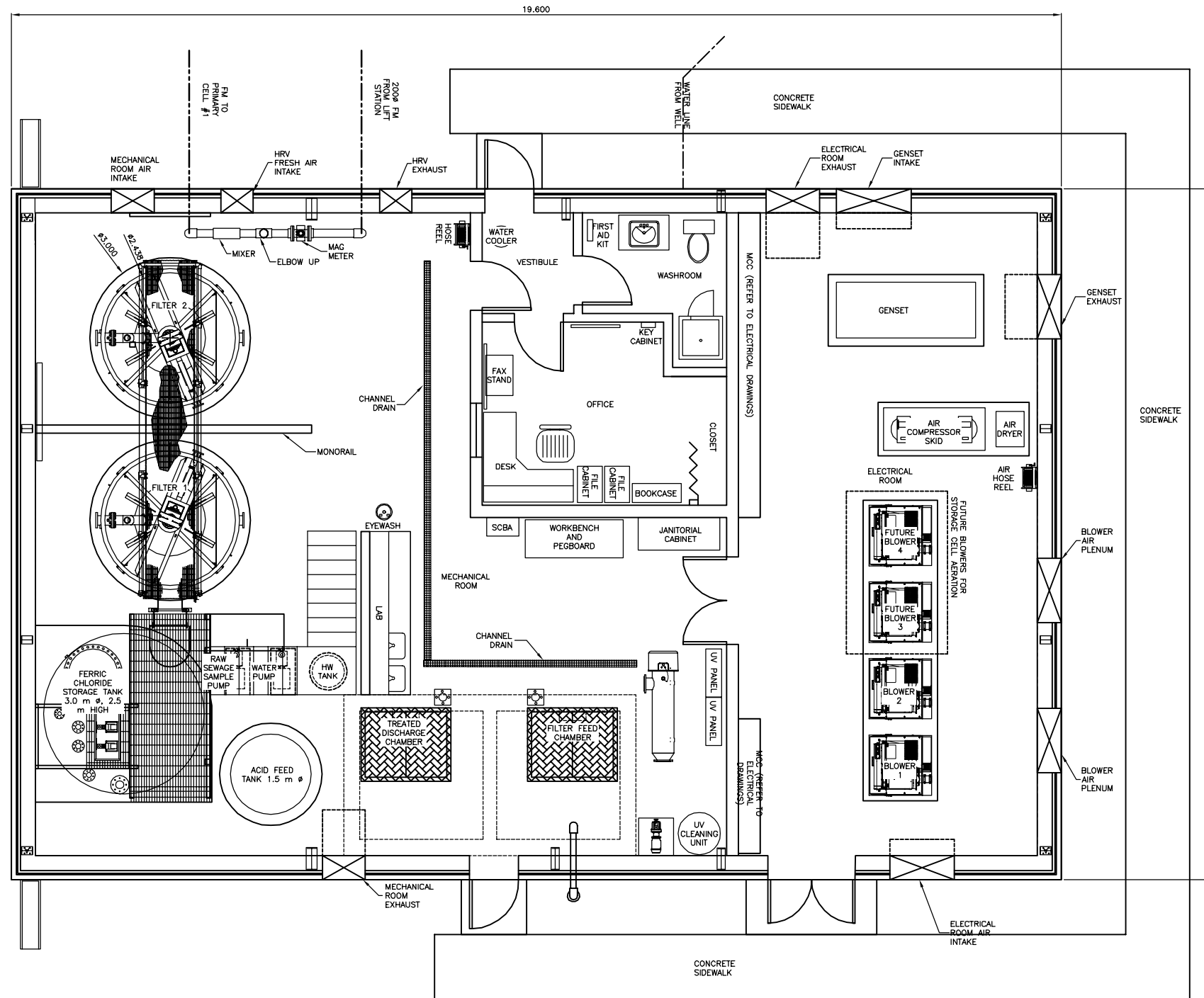

No.	REVISIONS	DATE	INITIALS

B.M. EL.

LOCATIONS OF UNDERGROUND STRUCTURES/UTILITIES AS SHOWN ARE BASED ON AVAILABLE INFORMATION BUT NO GUARANTEE IS GIVEN OR IMPLIED THAT ALL EXISTING UNDERGROUND STRUCTURES/UTILITIES ARE SHOWN OR THAT THE GIVEN LOCATIONS ARE EXACT. CONFIRMATION OF EXISTENCE AND EXACT LOCATION OF ALL UNDERGROUND STRUCTURES/UTILITIES MUST BE OBTAINED FROM THE APPROPRIATE AUTHORITY/OWNER, BY THE CONTRACTOR, BEFORE PROCEEDING WITH CONSTRUCTION.

**APEGM**  
 Certificate of Authorization  
**J.R. Cousin Consultants Ltd.**  
 No. 234 Date: 14/12/18



**JR Cousin Consultants Ltd.**  
 91A Scurfield Blvd. Winnipeg MB R3Y1G4  
 p. (204) 489-0474  
 f. (204) 489-0487  
 www.jrcc.ca

**ENGINEERING CONSULTANTS**  
 ENGINEERING EXCELLENCE SINCE 1981

CODE: L-169.75	PROJECT: RM OF LA BROQUERIE AWARATED LAGOON
DESIGNED BY: BM	TITLE: PRELIMINARY BUILDING LAYOUT
DRAWN BY: MP	
REVIEWED BY: JC	
SCALE: 1:50	DATE: 14/12/15
PLAN: L6	SHEET: 6 of 6

Dec. 16, 2014 - 10:00 AM La Broquerie Awarated Lagoon Expansion Pre-Design and Design/Construct/Drawings/SP/LS-Building Layout.dwg