



Manitoba Infrastructure and Transportation

Work Zone Traffic Control Manual

Provincial Roads
and
Provincial Trunk Highways



Manitoba 
Infrastructure and
Transportation
Traffic Engineering

EDITION 2015

2015 Work Zone Traffic Control Manual

Interim Release

In December, 2013, the Government of Manitoba passed Highway Traffic Act (HTA) amendments that required the establishment of Designated Construction Zones for prescribed projects and prohibited the use of the '60 When Passing Workers' sign on all highways throughout Manitoba.

As a result of the introduction of these regulations the Work Zone Policies and Traffic Management Plans (TMP's) contained in Manitoba Infrastructure and Transportation's *Work Zone Traffic Control Manual* required significant revision to comply with the HTA amendments.

This interim release of the **2015 Work Zone Traffic Control Manual** is the second step in providing an updated resource for contractors, MIT personal, utility companies, and others who carry out work on provincial highways.

This initial release includes a full complement of updated TMP's providing the minimum standard for the protection of road users and workers on Manitoba's highways. In addition four updated policies reference in the TMP's are also being released at this time.

It is anticipated that the entire 2015 Workzone Traffic Control Manual with a full complement of updated policies will be ready for release later this year. In the interim, users are asked to reference the policies in the 2013 manual for general guidance keeping in mind that the 2013 changes to the HTA have not been reflected in these documents.

Some of the key changes in 2015 manual include:

- The definitions of Short Term and Long Term work have been revised to align with DCZ legislation. Short Term work is any work less than 4 hours in duration. Long term work is any work more than 4 hours in duration.
- As outlined in Policy 915-A-7, Manitoba Infrastructure and Transportation requires that all **work zones within a declared provincial highway or provincial road right-of-way be established as a Designated Construction Zone if the duration of the work is more than 4 hours.** The 4 hour time limit shall be the sole criteria used to determine if a DCZ will be established. The location of the work within the right-of-way, the nature of the roadway surface, and the posted speed limit on the highway shall not be determining factors for the establishment of DCZ's on provincial highways and roads.
- The decision to reduce speeds within a work zone should only be taken after a risk analysis has been conducted. Specific guidelines governing the

establishment of regulatory speed reductions on provincial highways are provided in Policy 915-A-6.

- As outlined in Policy 915-E-1, mandatory speed reductions to 60 km/h are required for flagging operations on highways with an Annual Average Daily Traffic (AADT) volume greater than 1000 vehicles per day.

Please contact the Traffic Engineering Branch at (204) 945-3781 for advice and recommendations on dealing with traffic control situations not included in this manual, or where standards in the manual fail to adequately control traffic or protect workers.

Original Signed By

Glenn Cuthbertson P. Eng.

Director, Traffic Engineering Branch

2015 WORK ZONE TRAFFIC CONTROL MANUAL

TABLE OF CONTENTS

A – Standards, Guidelines and Legislation

- 915-A-1 Introduction
- 915-A-2 General Guidelines
- 915-A-3 Bilingual Traffic Signing (incl. Bilingual Signing Area Maps)
- 915-A-4 Working near Railway Crossings
- 915-A-5 Temporary Storage of Objects in Right-of-Way
- 915-A-6 Speed Limits in Work Zones**
- 915-A-7 Designated Construction Zones**
- 915-A-8 Night Work
- 915-A-9 Shoo-fly Detour Standards

B – Fundamental Principles

- 915-B-1 Overview of Fundamental Principles
- 915-B-2 Work Zone Requirements
- 915-B-3 Worker Visibility on Roadway
- 915-B-4 Vehicle Visibility on Roadway

C – Work Zone Components

- 915-C-1 Overview of Work Zone Components
- 915-C-2 Transition Tapers**

D – Traffic Control Devices

- 915-D-1 Signs
- 915-D-2 Sign Placement
- 915-D-3 Portable Signs
- 915-D-4 Optional Sign Mounting Locations
- 915-D-5 Sign Spacing
- 915-D-6 Truck Entrance Signing
- 915-D-7 Overhead Wires Signing
- 915-D-8 Pavement Markings (formally Passing Restrictions)
- 915-D-9 Barricades
- 915-D-10 Gateway Assembly
- 915-D-11 Channelizers and Delineators (combine with former Hazard Markers)
- 915-D-12 Variable Message Signs
- 915-D-13 Speed Reader Boards
- 915-D-14 Precast Concrete Median Barrier
- 915-D-15 Tritan Barrier
- 915-D-16 Crash Attenuators

- 915-D-17 Temporary Traffic Signals
- 915-D-18 Sign Reflectivity
- 915-D-19 Maintenance
- 915-D-20 Enhancement
- 915-D-21 Temporary Rumble Strips

E – Flagging Operations

- 915-E-1 Flagpersons
- 915-E-2 Flagman for String-line Person
- 915-E-3 Flagman for Worker Installing Temporary Overlay Marker
- 915-E-4 Flagman for Paving Operations
- 915-E-5 Survey Crew Traffic Control
- 915-E-6 Pilot Vehicle Traffic Control
- 915-E-7 Daylight Detour - Flagpersons Required Continuously
- 915-E-8 Remote Controlled Mechanical Flaggers

F – Setting up Work Zones

- 915-F-1 Traffic Management Plans
- 915-F-2 Traffic Control Coordinator
- 915-F-3 Installation and Removal of Traffic Control Devices
- 915-F-4 Mobile Operations
- 915-F-5 Fast Moving Operations
- 915-F-6 Short Duration Work
- 915-F-7 Long Duration Work
- 915-F-8 Roadside Work and Shoulder Work
- 915-F-9 Lane Closures
- 915-F-10 Bridge Work
- 915-F-11 Shoo-Fly Detours
- 915-F-12 Four Lane Divided Highway - Conversion to 2L2W Operation
- 915-F-13 Route Detours
- 915-F-14 New 4-Lane Divided Highway Intersection Traffic Control
- 915-F-15 Intersection Work

Appendix A – Typical Traffic Management Plans

Appendix B - Traffic Sign Schedule

Appendix C - Traffic Sign Schedule (Bilingual Signs)

**Work Zone Traffic Control
 Standards, Guidelines and Regulations
 Speed Limits in Work Zones**

Purpose

It may be necessary to control traffic speeds in work zones by the use of regulatory speed limits. Under Section 79(6) of The Highway Traffic Act the Minister of Infrastructure and Transportation, as traffic authority on provincial highways, may set the maximum speed at which vehicles may be driven on a highway. This authority has been delegated to the Director of Traffic Engineering.

Policy

The decision to reduce speeds within a work zone should only be taken after a risk analysis has been conducted. Factors to be considered when evaluating the need for a speed reduction include: the duration and nature of the work zone hazard or condition; highway geometry; environmental conditions; traffic volume; traffic speed; the longitudinal offset between the hazard/condition and traffic; and the potential negative impact of a speed reduction on vehicular collision frequency.

Only traffic authorities (the Director of Traffic Engineering on provincial highways) are authorized to approve speed reductions in work zones. A traffic authority may reduce the maximum speed in all or part(s) of a work zone. Longer work zones may have a number of reduced speed areas to enhance the safety of workers and road users.

Pre-approved Speed Reductions

Where a risk analysis supports the need for a speed reduction, the Director of Traffic Engineering has granted blanket pre-approval for regulatory speed reductions for the following common work zone conditions and hazards:

WORK ZONE CONDITION / HAZZARD	PRE-APPROVED MINIMUM SPEED LIMIT	APPROVED EXTENT OF REDUCED SPEED ZONE*
Workers are located in close proximity to traffic (up to a maximum of 12m from an open traffic lane)	60 Km/h	500m in advance of workers to 300m beyond workers
A significant unprotected roadside hazard (e.g. excavation area) is located within the clear zone	70 Km/h	500m in advance of hazard to 300m beyond hazard
The conversion of a 4-lane divided highway to 2 lane/2 way operation	80 Km/h	500m in advance of 2 lane/2 way operation to 300m beyond 2 lane/2 way operation

*Unless otherwise shown in an approved Traffic Management Plan

Written approval must be obtained from the Director of Traffic Engineering for any speed reduction that falls outside of the above pre-approved guidelines (contact MIT's Traffic Engineering Branch at 204-945-3781).

The use of reduced speed limit signs must be limited to those specific sections of highway where the condition or hazard exists. They must **NOT** be used throughout the project unless the condition or hazard dictates. Speed limit signs must be removed immediately when the conditions change or hazards no longer exist.

Where operations dictate, multiple regulatory speed reductions may be established within a single work zone. Typically when work areas are separated by more than 3 km individual regulatory speed reductions will be required with the speed limit being returned to normal levels between each work area.

Procedures

In the past, traffic authorities/contractors commonly used the '60 When Passing Workers' sign to inform drivers to reduce their speed. This sign, and any similar sign that links a speed reduction to the presence or absence of workers/equipment, is now *prohibited* from use on all highways throughout Manitoba.

Traffic authorities/contractors must now identify all maximum speed reductions in work zones using the sequence of regulatory signage detailed below (typical examples of signing for regulatory speed reductions in both single and multiple work areas are illustrated at the end of this policy).

Reduced-Speed Ahead Warning Sign

- A reduced-speed ahead warning sign (WB-9) is to be placed in advance of the speed reduction.



Maximum Speed Signs

- The beginning of a reduced-speed area must be identified using a regulatory 'Maximum Speed' sign (RB-1).

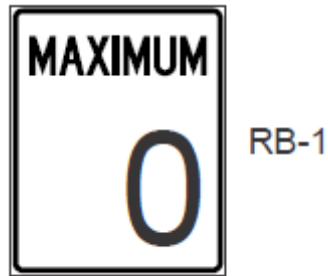

- The end of a reduced-speed area **must** be identified using a regulatory 'Maximum Speed' sign (RB-1) to inform drivers that they may increase their speed to the normal posted maximum.
- All existing regulatory speed signs within the reduced speed zone **must** be covered. This may be accomplished using a number of methods such as affixing an opaque material securely to the face of the sign or by using the sign cover device illustrated below which eliminates the need for a ladder.

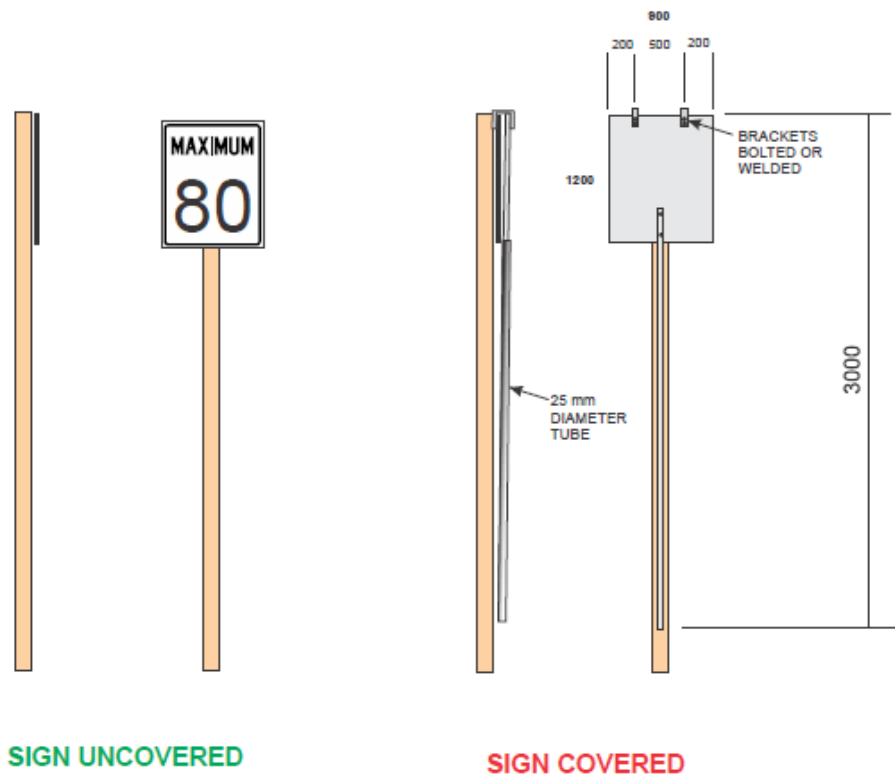

A written record detailing the location, time of installation and time of removal of all regulatory speed reductions must be maintained by the traffic authority/contractor.

Speed limit signs should be repeated at minimum 1 km intervals, and following intersections.

Note: These approved speed limits in construction and maintenance areas are enforceable by R.C.M.P. or local police.

TYPICAL SPEED REDUCTION IN THE WORK ZONE

SHORT DURATION SINGLE WORK AREA

S(km/h)	A(m)	L(m)	B(m)	D(m)
50	50	60	35	15
60	50	90	45	15
70	75	120	50	15
80	100	175	55	15
90	100	200	65	20
100	150	250	70	20
110	150	250	75	20

WHERE:

- S = SPEED LIMIT
- A = SPACING BETWEEN SIGNS
- L = LENGTH OF TAPER
- B = LENGTH OF LONGITUDINAL BUFFER SPACE
- D = SPACING BETWEEN CHANNELIZATION DEVICES
- O = POLYPOSTS

WORK AREA SHOWN FOR
ILLUSTRATIVE PURPOSES.
ACTUAL WORK AREA
MAY VARY.

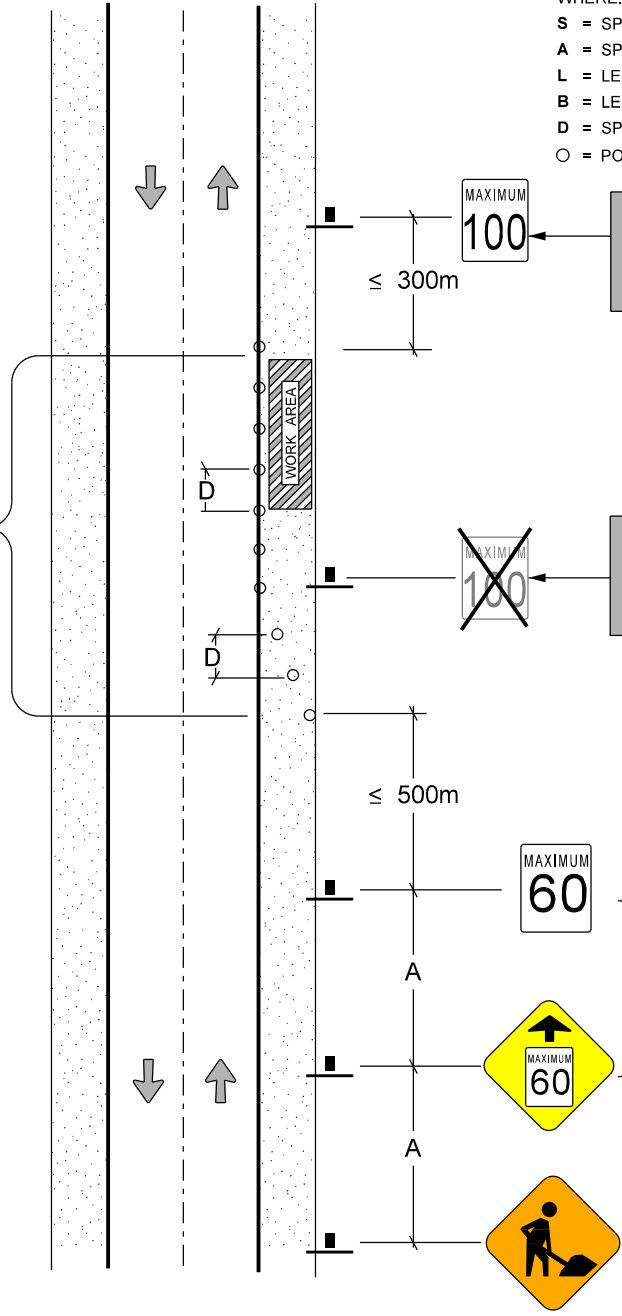

A REGULATORY SPEED RELEASE
SIGN SHALL BE USED AT THE END
OF ALL REDUCED SPEED ZONES

ALL EXISTING SPEED LIMIT SIGNS
WITHIN THE REDUCED SPEED
ZONE SHALL BE COVERED.

ACTUAL REDUCED SPEED LIMIT
WILL VARY DEPENDING ON
CONDITIONS.
SEE POLICY 915-A-6 FOR DETAILS.

TYPICAL SPEED REDUCTION IN THE WORK ZONE

LONG DURATION SINGLE WORK AREA

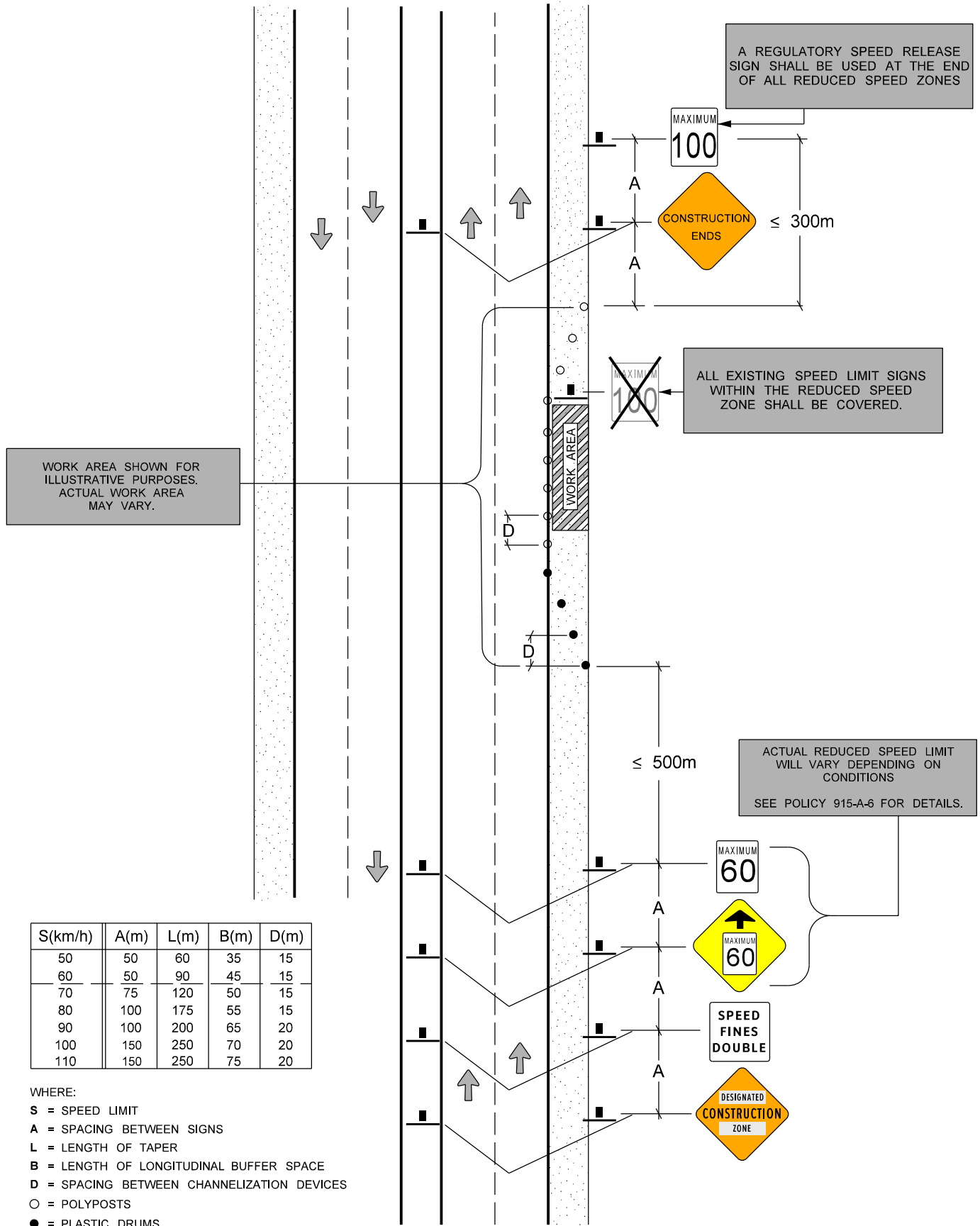

TYPICAL SPEED REDUCTION IN THE WORK ZONE

SHORT DURATION MULTIPLE WORK AREAS

WHERE WORK AREAS ARE SEPARATED BY MORE THAN 3km. TRAFFIC SHALL BE RETURNED TO THE NORMAL REGULATORY SPEED LIMIT.

WORK AREAS SHOWN FOR ILLUSTRATIVE PURPOSES. ACTUAL WORK AREAS MAY VARY.

S(km/h)	A(m)	L(m)	B(m)	D(m)
50	50	60	35	15
60	50	90	45	15
70	75	120	50	15
80	100	175	55	15
90	100	200	65	20
100	150	250	70	20
110	150	250	75	20

WHERE:

- S = SPEED LIMIT
- A = SPACING BETWEEN SIGNS
- L = LENGTH OF TAPER
- B = LENGTH OF LONGITUDINAL BUFFER SPACE
- D = SPACING BETWEEN CHANNELIZATION DEVICES
- O = POLYPOSTS

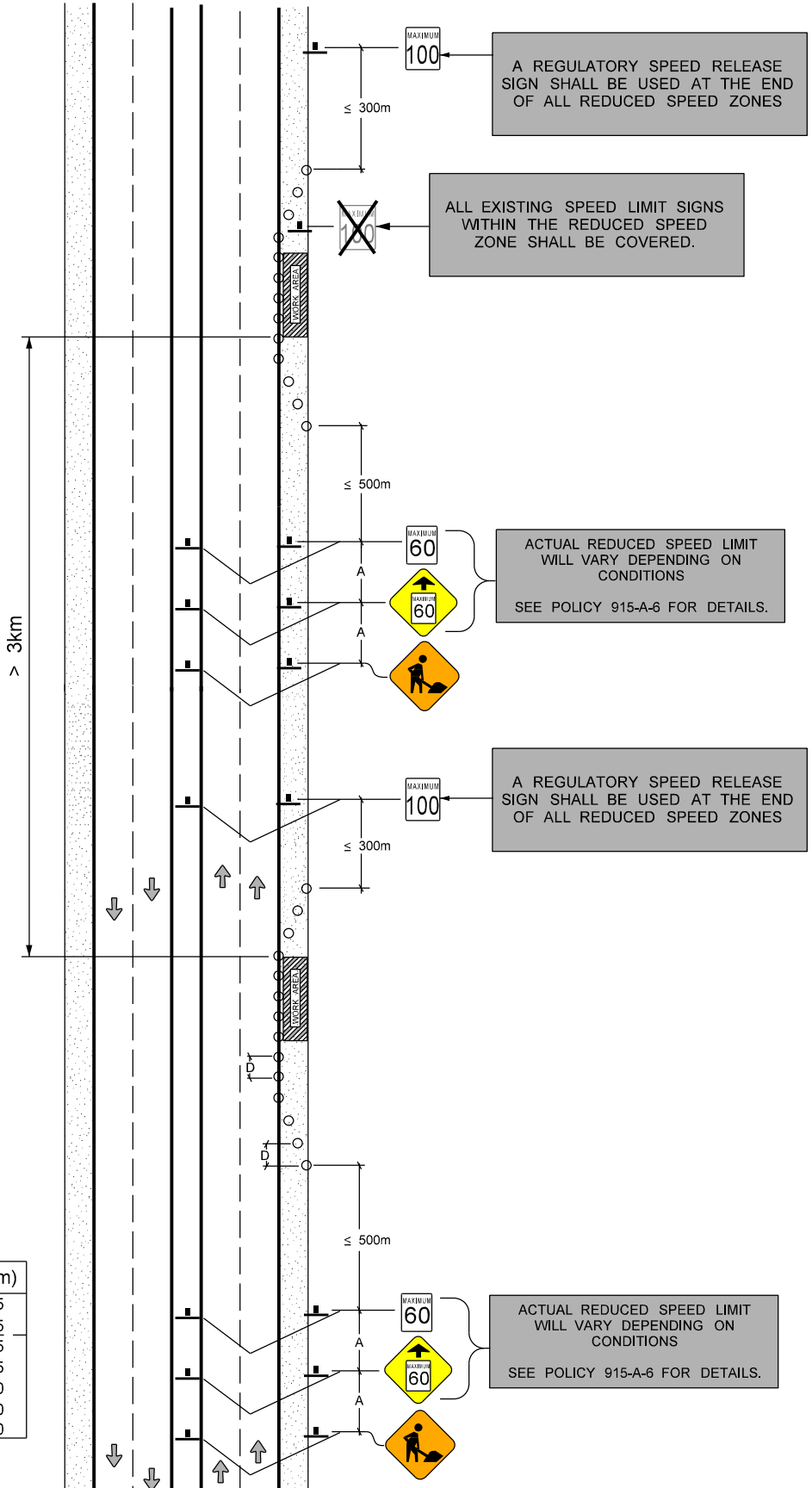

A REGULATORY SPEED RELEASE SIGN SHALL BE USED AT THE END OF ALL REDUCED SPEED ZONES

ALL EXISTING SPEED LIMIT SIGNS WITHIN THE REDUCED SPEED ZONE SHALL BE COVERED.

ACTUAL REDUCED SPEED LIMIT WILL VARY DEPENDING ON CONDITIONS
SEE POLICY 915-A-6 FOR DETAILS.

A REGULATORY SPEED RELEASE SIGN SHALL BE USED AT THE END OF ALL REDUCED SPEED ZONES

ACTUAL REDUCED SPEED LIMIT WILL VARY DEPENDING ON CONDITIONS
SEE POLICY 915-A-6 FOR DETAILS.

TYPICAL SPEED REDUCTION IN THE WORK ZONE

LONG DURATION MULTIPLE WORK AREAS

WHERE WORK AREAS ARE SEPARATED BY MORE THAN 3km. TRAFFIC SHALL BE RETURNED TO THE NORMAL REGULATORY SPEED LIMIT.

WORK AREAS SHOWN FOR ILLUSTRATIVE PURPOSES. ACTUAL WORK AREAS MAY VARY.

S(km/h)	A(m)	L(m)	B(m)	D(m)
50	50	60	35	15
60	50	90	45	15
70	75	120	50	15
80	100	175	55	15
90	100	200	65	20
100	150	250	70	20
110	150	250	75	20

WHERE:

- S = SPEED LIMIT
- A = SPACING BETWEEN SIGNS
- L = LENGTH OF TAPER
- B = LENGTH OF LONGITUDINAL BUFFER SPACE
- D = SPACING BETWEEN CHANNELIZATION DEVICES
- = POLYPOSTS
- = PLASTIC DRUMS

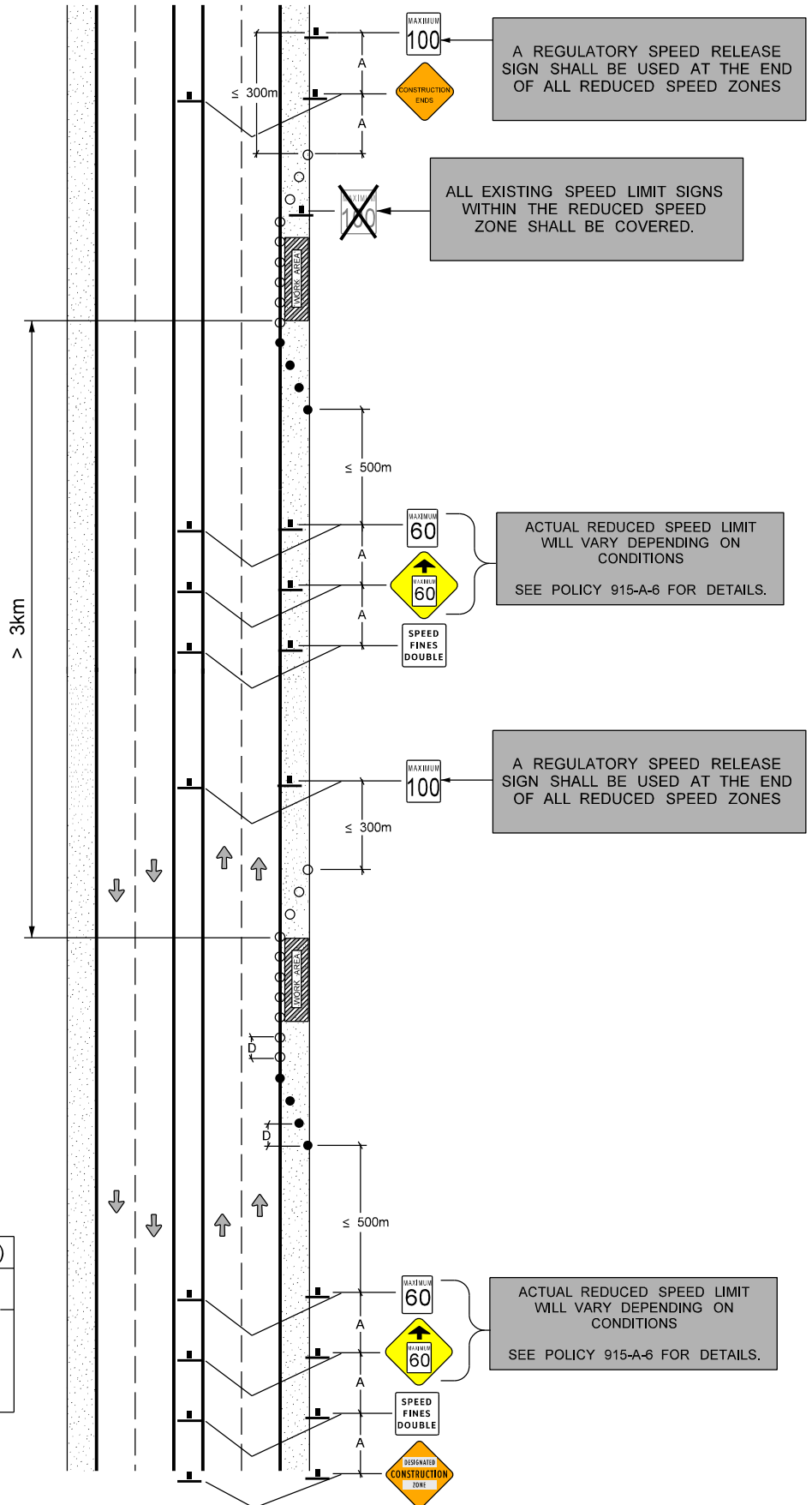

A REGULATORY SPEED RELEASE SIGN SHALL BE USED AT THE END OF ALL REDUCED SPEED ZONES

ALL EXISTING SPEED LIMIT SIGNS WITHIN THE REDUCED SPEED ZONE SHALL BE COVERED.

ACTUAL REDUCED SPEED LIMIT WILL VARY DEPENDING ON CONDITIONS
SEE POLICY 915-A-6 FOR DETAILS.

A REGULATORY SPEED RELEASE SIGN SHALL BE USED AT THE END OF ALL REDUCED SPEED ZONES

ACTUAL REDUCED SPEED LIMIT WILL VARY DEPENDING ON CONDITIONS
SEE POLICY 915-A-6 FOR DETAILS.

**Work Zone Traffic Control
Standards, Guidelines and Regulations
Designated Construction Zones**

Purpose

In December, 2013, the Government of Manitoba passed Highway Traffic Act (HTA) amendments that double the set fines for speeding in a designated construction zone (DCZ). The amendments authorize double fines for speeding:

- Whether or not there are workers/equipment present; and
- Whether or not there is a reduction in the maximum speed within the DCZ.

The amendments require traffic authorities, and contractors working on their behalf, to establish DCZs, and to identify them using the signage prescribed in the Designated Construction Zones Regulation.

Regulation

A traffic authority/contractor must establish a work zone as a DCZ if the work being undertaken on a road meets ALL of the following conditions:

1. Work is on the roadway portion of a highway, i.e. the area of a highway where vehicles travel, this does not include the shoulder, sidewalk or ditch/median;
2. Work is 4 hours or more in duration;
3. Work is on a paved roadway; and
4. Work is on a road where the maximum speed is 80 km/h or more.

Optional DCZ's

A traffic authority has the option of establishing a work zone as a DCZ if doing so will enhance the safety of workers and other road users. To do this, the work being undertaken must be road construction, reconstruction, widening, improvement, repair, or other similar work in relation to the road.

RECOMMENDED: “ORIGINAL SIGNED BY”
Director, Traffic Engineering

APPROVED: “ORIGINAL SIGNED BY”
Executive Director
Highway Engineering









Policy

As permitted by regulation, Manitoba Infrastructure and Transportation (the traffic authority on provincial highways) has narrowed the DCZ criteria outlined above. MIT requires that all work zones within a declared provincial highway right-of-way be established as a Designated Construction Zone if the duration of the work is **more than 4 hours**. The 4 hour time limit shall be the sole criteria used to determine if a DCZ will be established. The location of the work within the right-of-way, the nature of the roadway surface, and the posted speed limit on the highway shall not be determining factors for the establishment of DCZ's on provincial highways.

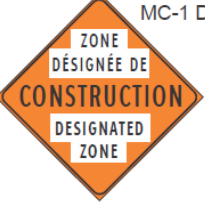
Procedures

DCZ Signage

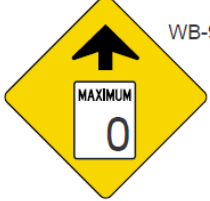
A traffic authority/contractor is responsible to erect/place the approved signage shown below:

 MC-1 D  MC-1 DF  MC-1 DB 900mm x 900mm : 2 - LANE ROADWAY 1200mm x 1200mm : 4 - LANE ROADWAY	 MR-179 600mm x 600mm : 2 - LANE ROADWAY 900mm x 900mm : 4 - LANE ROADWAY	 MR-179 F
	 RB-1 600mm x 750mm : 2 - LANE ROADWAY 900mm x 1200mm : 4 - LANE ROADWAY	 WB-9 900mm x 900mm : 2 - LANE ROADWAY 1200mm x 1200mm : 4 - LANE ROADWAY
	 TC-4 DB 900mm x 900mm 2 - LANE OR 4 - LANE ROADWAY	
<p style="text-align: center;"><u>Designated Construction Zones</u> Sign Sizes based on Type of Roadway</p>		
Page 1 of 1 2014-05		

RECOMMENDED: "ORIGINAL SIGNED BY" _____
Director, Traffic Engineering

APPROVED: "ORIGINAL SIGNED BY" _____
Executive Director
Highway Engineering

Designated Construction Zone Sign

The beginning of a DCZ must be identified with the 'Designated Construction Zone' sign. Drivers must have an unimpeded view of the sign. In accordance with MIT's Standard Construction Specifications, Construction Area Signs are also to be installed at the intersection of every Provincial Trunk Highway or Provincial Road that enters onto the project.

Construction Ends Sign

The end of a DCZ must be marked with the 'Construction Ends' sign (TC-4 or TC-4 DB). Drivers must have an unimpeded view of the sign.

Speed Fines Double Warning Sign

At least one 'Speed Fines Double' sign (MR-179) must be placed within a DCZ and be no more than 150 m after the 'Designated Construction Zone' sign which marks the beginning of the DCZ.

A traffic authority/contractor may place more than one 'Speed Fines Double' sign in a DCZ to heighten driver awareness. The sign may also be used to mark a portion of road within the DCZ that intersects with another roadway. For example, where a high volume road intersects with a DCZ, the traffic authority/contractor may use the 'Speed Fines Double' sign to warn drivers entering the DCZ.

Bilingual Traffic Signing

Bilingual Traffic Signing Areas as identified in Policy 915-A-3 of this Manual shall be signed in both official languages using either the bilingual sign, or separate English and French signs with the French sign installed the English sign, at a distance of approximately 30m.

RECOMMENDED: "ORIGINAL SIGNED BY"
Director, Traffic Engineering

APPROVED: "ORIGINAL SIGNED BY"
Executive Director
Highway Engineering

Work Zone Traffic Control
Work Zone Components
Transition Tapers

Purpose

Transition tapers are used to channel/direct traffic around an activity area within a work zone. The length of the taper and the channelizer spacing is extremely important. Inadequate tapers result in undesirable traffic movements and increase the potential for accidents.

Policy

Whenever traffic must be moved from the normal path of travel due to the presence of an activity area, a proper transition taper must be installed. The transition area must be obvious to motorists, and must be delineated with channelizing devices so motorists do not mistakenly follow the wrong path. For long duration projects, existing pavement markings must be removed where they conflict with transition delineation. Additional pavement markings may need to be installed to guide motorists.

Taper lengths for the first taper encountered by a motorist as they enter a work zone shall be selected based on the posted speed limit in place prior to the work beginning. Taper lengths within an established work zone can be based on the reduced work zone speed limit.

Tapers on long term projects shall be delineated using Plastic Drums. For short term and fast moving operations tapers may be delineated using Poly Posts (See Policy 915-D-11 for additional information).

Standard

There are five common transition tapers as described below. The included tables provide normal taper lengths and channelization device spacing for the various taper types.

- **Merging Taper** - Merging tapers, used on multi-lane divided roadways to channel traffic from a closed lane into an adjacent lane, require the greatest length. A merge lane must allow a motorist to locate and move into a gap in the adjacent traffic stream. On typical traffic management plans this distance is represented by the letter "L".
- **Shifting Taper** - When a merge is not required, a shifting taper is used to channel vehicles onto a different travel path. This taper is often used when traffic is routed around a work area by shifting it onto the shoulder or median. Changes in the travel path may also be accomplished with horizontal curves designed for normal highway speeds. Shifting tapers are $\frac{1}{2}$ the length of a merging taper or " $\frac{1}{2}L$ " rounded up to the nearest 5m.

RECOMMENDED: "ORIGINAL SIGNED BY" _____
Director, Traffic Engineering
Engineering

APPROVED: "ORIGINAL SIGNED BY" _____
Executive Director Highway

- **Shoulder Taper** – Shoulder tapers are used to close shoulders. This taper provides a visual clue to passing traffic indicating that the shoulder is closed. Because traffic is not required to merge or shift for a shoulder taper the required length is 1/3 the merging taper length or “1/3L” rounded up to the nearest 5m.
- **One-Lane Traffic Taper** - A one-lane traffic taper is used in advance of work areas that require a portion of the road be used alternately by traffic in both directions. Traffic is typically controlled by flagpersons and since no merging is taking place, the taper used to direct vehicles onto the one-way road section can be quite short. One Lane tapers are always 30m in length.
- **Downstream Taper** - A downstream taper is placed at the end of the work zone to indicate that vehicles can safely move back onto the lane that was closed. They are placed in the termination area and are the same length as one-lane traffic tapers. Downstream tapers are always 30m in length.

Minimum Taper Lengths (m)

Normal Operating Speed (km/h)	Merging Taper (L)	Shifting Taper (L/2)	Shoulder Taper (L/3)	One Lane Traffic Taper	Downstream Taper
50	60	30	20	30	30
60	90	50	30	30	30
70	120	60	40	30	30
80	175	90	60	30	30
90	200	100	70	30	30
100	250	125	85	30	30
110	250	125	85	30	30

Maximum Channelization Device Spacing (m)

Normal Operating Speed (km/h)	Merging Taper (D)	Shifting Taper (D/2)	Shoulder Taper (D/3)	One Lane Traffic Taper	Downstream Taper
50	15	10	5	5	5
60	15	10	5	5	5
70	15	10	5	5	5
80	15	10	5	5	5
90	20	10	10	5	5
100	20	10	10	5	5
110	20	10	10	5	5

**Work Zone Traffic Control
Flagging Operations
Flagpersons**

Purpose

The flagperson (alternately referred to as "flagman", "flagger" or "traffic control person") is one of the most effective and flexible "devices" available to control traffic in work zones. For a variety of reasons the flagperson has one of the most difficult jobs to perform.

In Section 77(10) of The Highway Traffic Act, a **flagperson** is defined as:

"a person employed by a traffic authority, or a contractor doing work on behalf of a traffic authority, for the purpose of directing the movement of traffic on any portion of a highway under construction, or where repair work or other work is being carried on".

Under Section 77(11) of The Highway Traffic Act

"every driver of a vehicle shall obey and observe the directions given by a flagman".

The Highway Traffic Act gives the flagperson the authority to control traffic by signalling for a motorist to stop, to reduce speed, to proceed as directed, or by advising how to pass safely through or around a work area.

Standard

To optimize this traffic control function the following guidelines/principles should be utilized when controlling traffic through a work area by the use of flagpersons.

- All flagpersons shall be trained, certified, and equipped in accordance with The Workplace Safety and Health Act (Manitoba) and associated regulations.
- Flagging operations shall be conducted in accordance with the procedures outlines in the *Manitoba Flagperson Training Manual*
- A symbolic Flagperson Ahead sign (MC-64) should always be placed a minimum of 150 m in advance of the flagperson. The back of the Flagperson Ahead sign must be visible to the flagperson at all times and should never be located more than 500 m from the Flagperson.

RECOMMENDED: "ORIGINAL SIGNED BY"

Director, Traffic Engineering

APPROVED: "ORIGINAL SIGNED BY"

Executive Director
Highway Engineering

- The "stop/slow" sign paddle (MC-44A / MC-44A B) will be used by all flagpersons.



MC-64
900 x 900



MC-44A
450 x 450



MC-44A B
450 x 450

(BILINGUAL TRAFFIC SIGNING AREAS)

- Flagpersons will typically be used under the following circumstances:
 - To stop and release traffic on an alternating basis when a two lane road is converted to one-way operation.
 - When it is necessary to give some message to the motorist to allow them to safely traverse a work area.
 - To slow traffic that is passing workers in an exposed location during hazardous operations (e.g. paving operations, string line installation, temporary overlay marker installation, centreline survey work, etc...)
 - To control traffic during a pilot vehicle operations
- In areas of high traffic volume an additional mobile flagperson shall be provided to move back as the queue builds up beyond the view of the initial flagperson. Furthermore, an additional Flagperson Ahead sign shall be installed a minimum 150m in advance of the end of the vehicle queue.

-
- On higher volume highways (AADT > 1000 VPD) a regulatory speed reduction to 60 km/h shall be instituted in advance of the flagging station. On lower volume highways (AADT < 1000 VPD) a regulatory speed reduction is not mandatory but should be considered if sight lines to the flagging station are obstructed by roadway geometry, environmental conditions, or if operational conditions dictate.
 - Overuse of flagpersons causes disrespect by the public, for the function. When not needed as a flagperson, that person should be taken out of view of the motorist, and possibly given some other duty.
 - The flagperson must be kept apprised of the changing conditions in the work area so he/she can effectively communicate with the motorist.

Note: Refer to the *Manitoba Flagperson Training Manual* for information about employer and employee responsibilities, equipment, clothing, flagging practices, and procedures.

Appendix A

Typical Traffic Management Plans

Traffic Management Plan Index

Typical Activity	Type of Work			
	Mobile	Fast Moving	Short Duration	Long Duration
Roadside Work and Shoulder Work on a Two-Lane Road				
Right Shoulder Work	TMP-915- 1	TMP-915- 1	TMP-915- 2	TMP-915- 3
Encroachment in Right Lane	TMP-915- 4	TMP-915- 5	TMP-915- 5	TMP-915- 6
Roadside Work and Shoulder Work on a Multi-Lane Road				
Right Shoulder Work	TMP-915- 1	TMP-915- 1	TMP-915- 2	TMP-915- 3
Left Shoulder Work	TMP-915- 7	TMP-915- 7	TMP-915- 8	TMP-915- 9
Work in Median	TMP-915- 10	TMP-915- 11	TMP-915- 11	TMP-915- 12
Encroachment in Left Lane	TMP-915- 13	TMP-915- 14	TMP-915- 14	TMP-915- 15
Encroachment in Right Lane	TMP-915- 4	TMP-915- 5	TMP-915- 5	TMP-915- 6
Single Lane Closed				
Two lane Road - Right Lane Closed	TMP-915- 16			
i) Yield to oncoming Traffic - Volume < 500 AADT		TMP-915- 17	TMP-915- 17	TMP-915- 18
ii) Flagperson - Volume 500 - 1000 AADT		TMP-915- 19	TMP-915- 19	TMP-915- 20
iii) Flagperson - Volume > 1000 AADT		TMP-915- 21	TMP-915- 21	TMP-915- 22
iii) Temporary Traffic Signals				TMP-915- 23
iv) Use Shoulder				TMP-915- 24
Multi Lane Road - Left Lane Closed	TMP-915- 25	TMP-915- 26	TMP-915- 26	TMP-915- 27
Multi Lane Road - Right Lane Closed	TMP-915- 25	TMP-915- 28	TMP-915- 28	TMP-915- 29
Median Cross-Over				
At Existing Intersection			TMP-915-30	TMP-915- 31
Detour				
Alternative Roads				TMP-915- 32
Shoo-Fly Detour				TMP-915- 33
Lane Closed at Intersection Two-Lane Roads				
Near Side Lane Closed		TMP-915- 34	TMP-915- 34	TMP-915- 35
Far Side Lane Closed		TMP-915- 36	TMP-915- 36	TMP-915- 37

RIGHT SHOULDER WORK

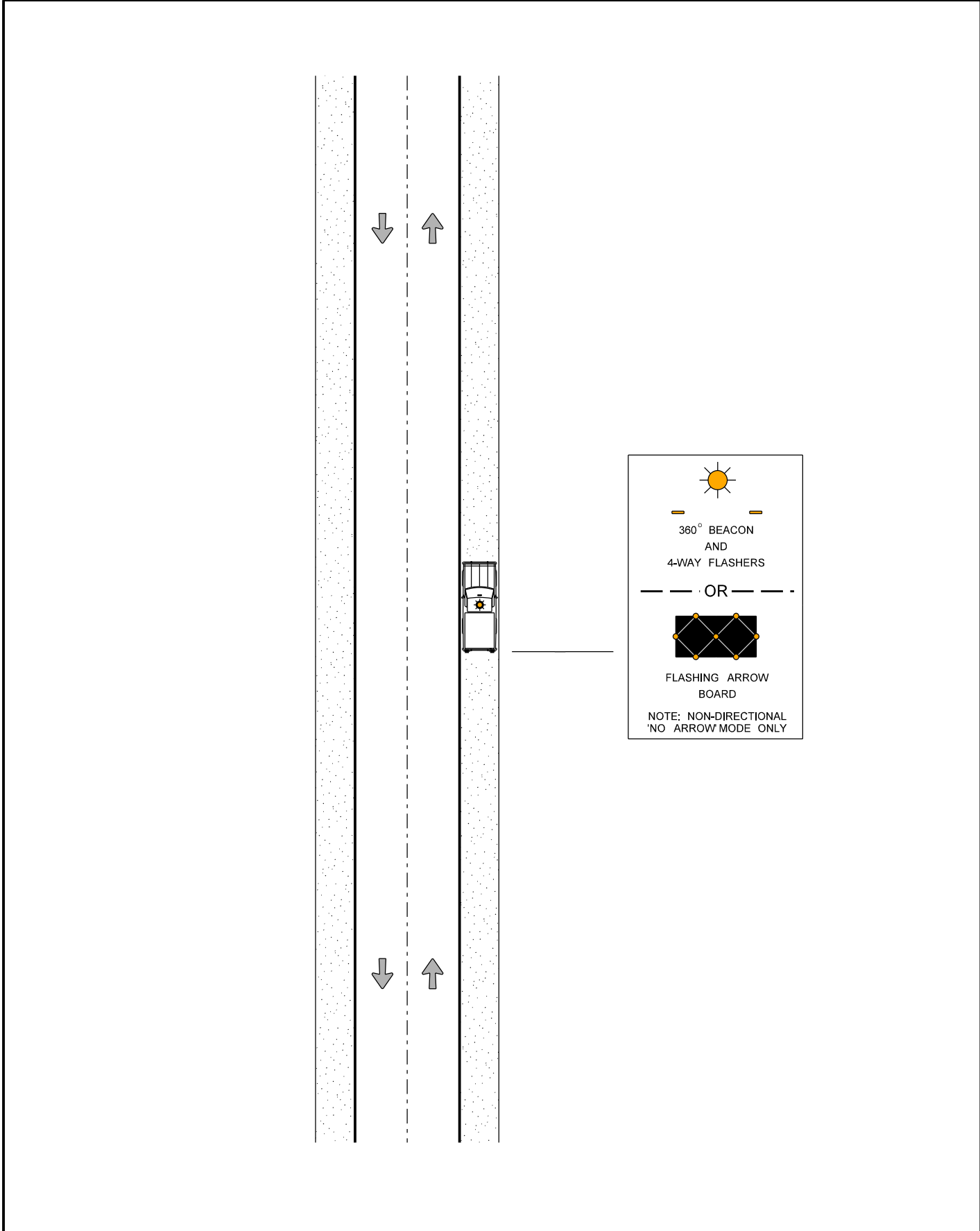

S(km/h)	A(m)	L(m)	B(m)	D(m)
50	50	60	35	15
60	50	90	45	15
70	75	120	50	15
80	100	175	55	15
90	100	200	65	20
100	150	250	70	20
110	150	250	75	20

WHERE:

S = SPEED LIMIT

A = SPACING BETWEEN SIGNS

L = LENGTH OF TAPER

B = LENGTH OF LONGITUDINAL BUFFER SPACE

D = SPACING BETWEEN CHANNELIZATION DEVICES

● = POLYPOSTS

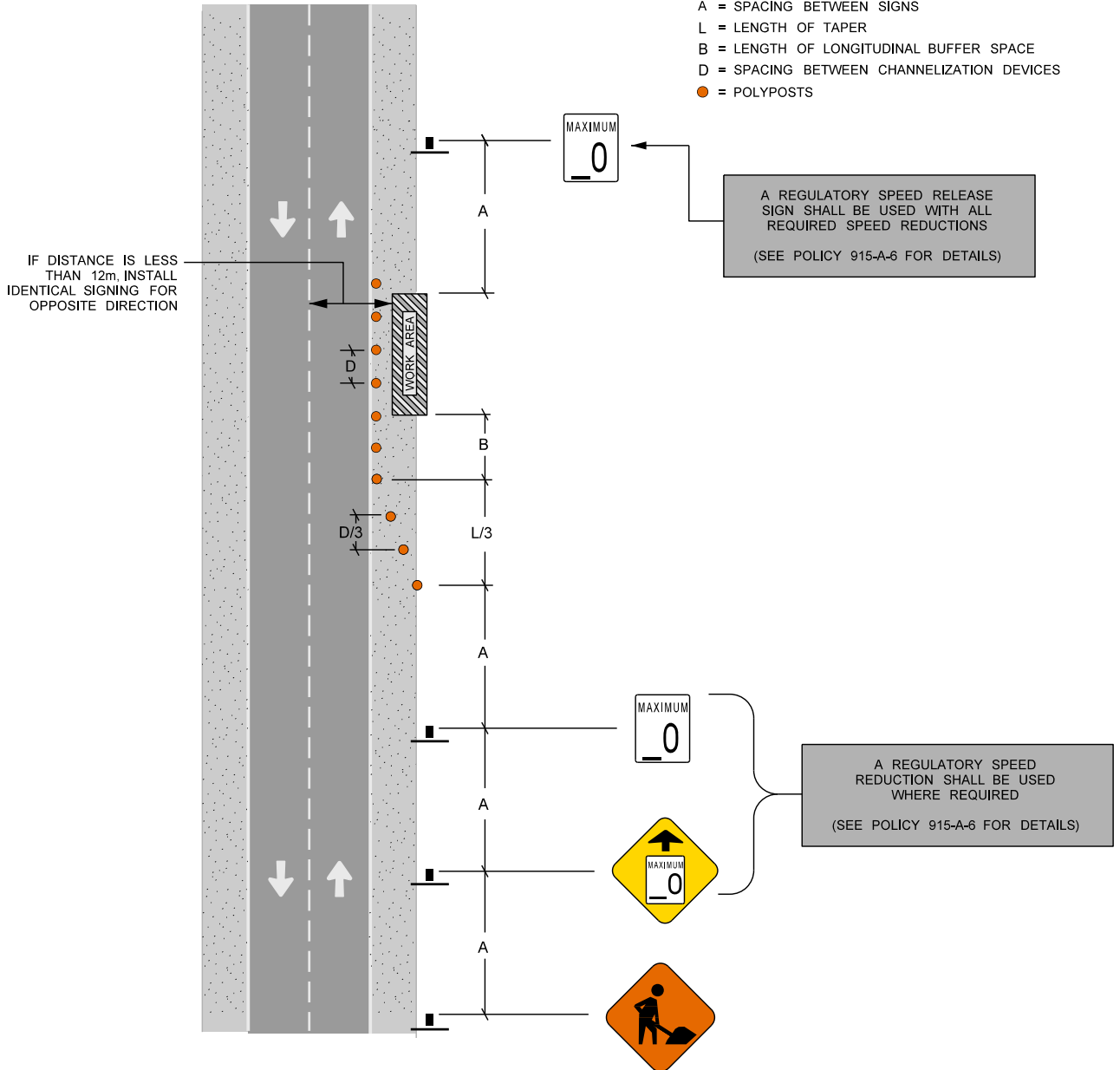

A REGULATORY SPEED RELEASE SIGN SHALL BE USED WITH ALL REQUIRED SPEED REDUCTIONS
(SEE POLICY 915-A-6 FOR DETAILS)

S(km/h)	A(m)	L(m)	B(m)	D(m)
50	50	60	35	15
60	50	90	45	15
70	75	120	50	15
80	100	175	55	15
90	100	200	65	20
100	150	250	70	20
110	150	250	75	20

WHERE:

- S = SPEED LIMIT
- A = SPACING BETWEEN SIGNS
- L = LENGTH OF TAPER
- B = LENGTH OF LONGITUDINAL BUFFER SPACE
- D = SPACING BETWEEN CHANNELIZATION DEVICES
- = POLYPOSTS
- = PLASTIC DRUMS

IF DISTANCE IS LESS THAN 12m, INSTALL IDENTICAL SIGNING FOR OPPOSITE DIRECTION

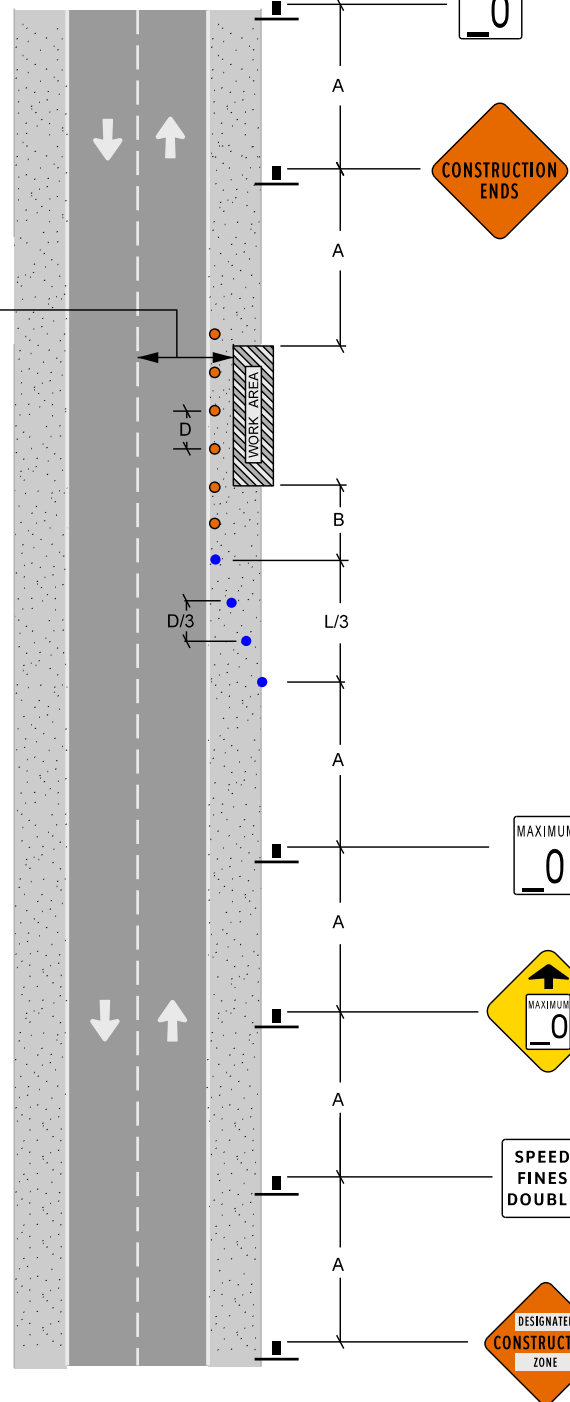

A REGULATORY SPEED REDUCTION SHALL BE USED WHERE REQUIRED
(SEE POLICY 915-A-6 FOR DETAILS)

ENCROACHMENT IN RIGHT LANE

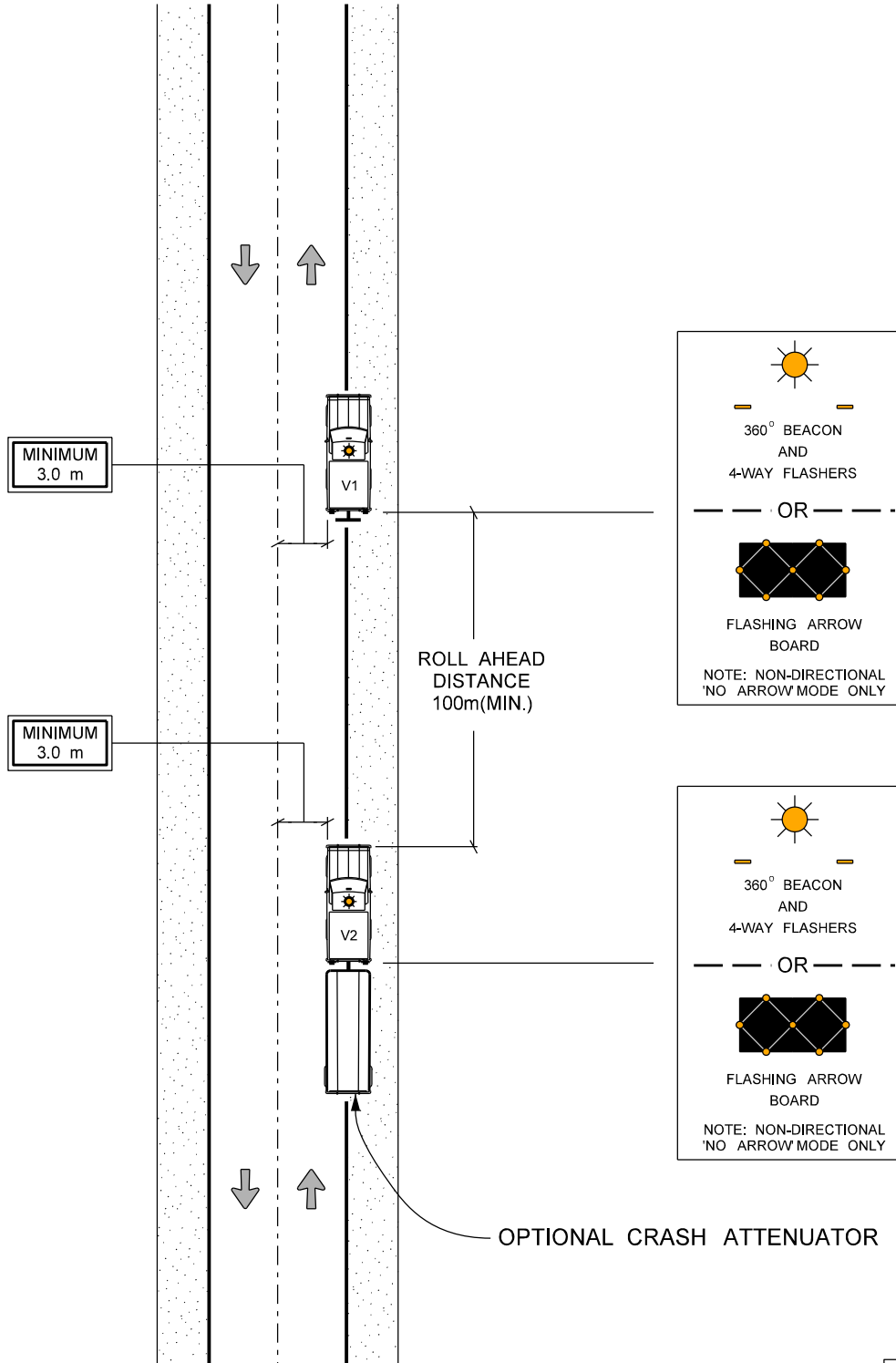

LEGEND	
V1	= WORK TRUCK
V2	= BUFFER TRUCK

ENCROACHMENT IN RIGHT LANE

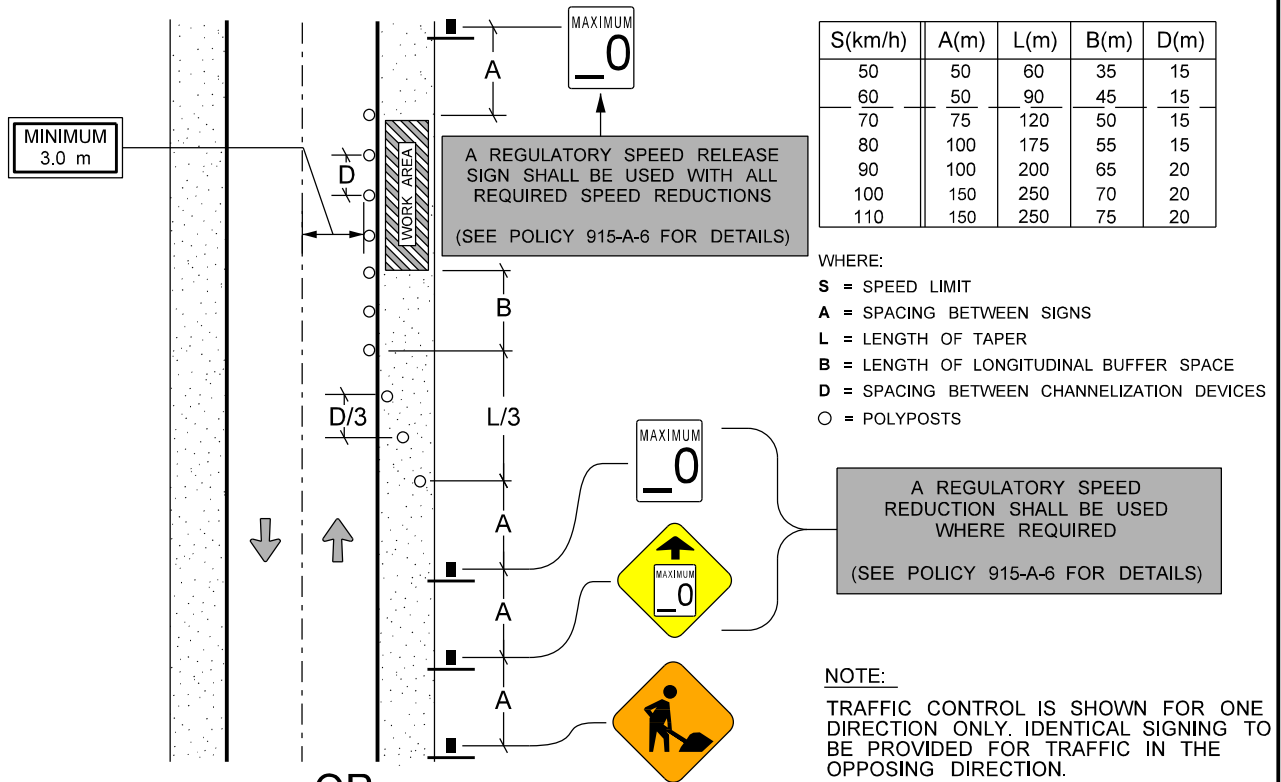

OR

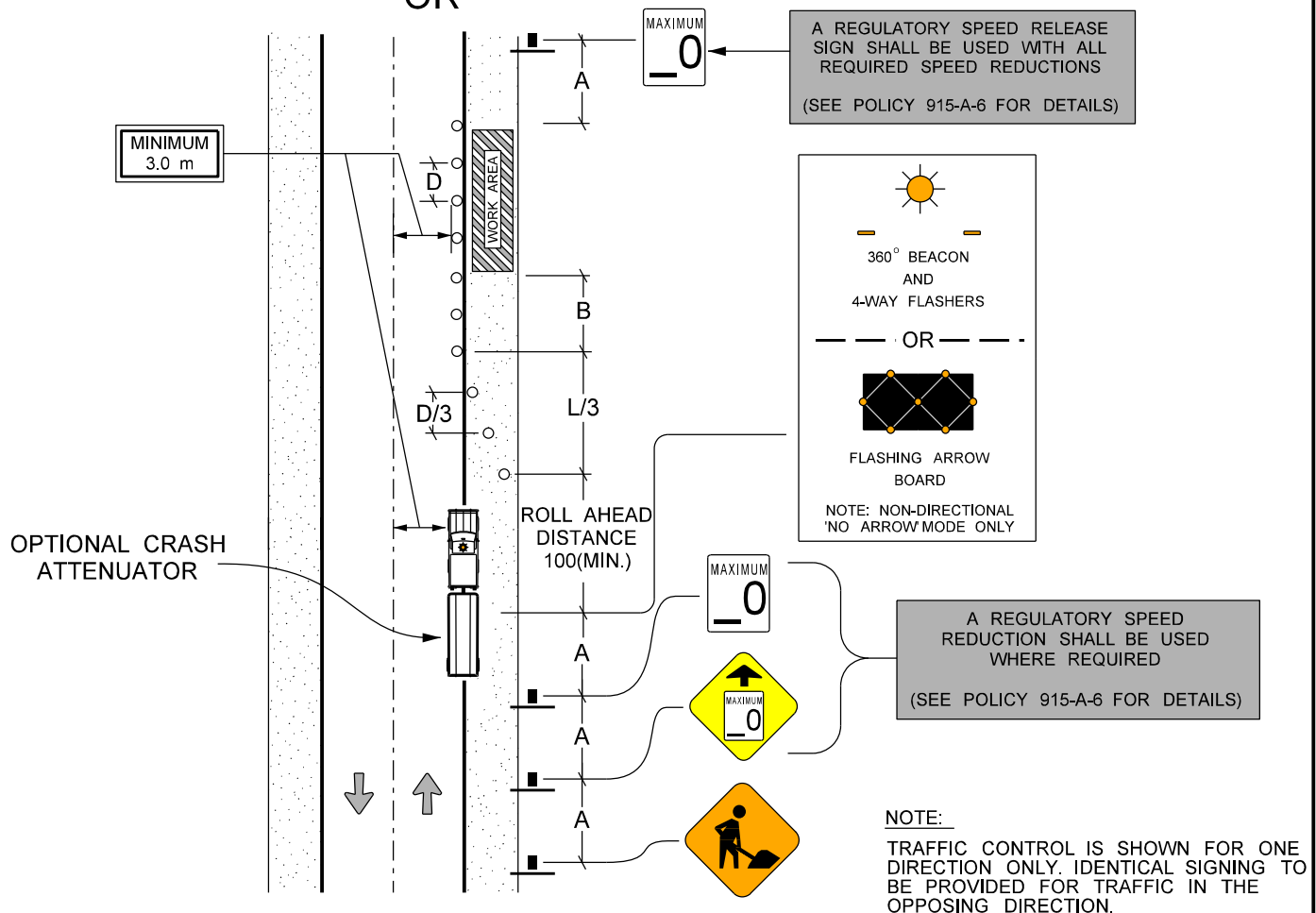

ENCROACHMENT IN RIGHT LANE

A REGULATORY SPEED RELEASE
SIGN SHALL BE USED WITH ALL
REQUIRED SPEED REDUCTIONS
(SEE POLICY 915-A-6 FOR DETAILS)

S(km/h)	A(m)	L(m)	B(m)	D(m)
50	50	60	35	15
60	50	90	45	15
70	75	120	50	15
80	100	175	55	15
90	100	200	65	20
100	150	250	70	20
110	150	250	75	20

WHERE:

- S = SPEED LIMIT
- A = SPACING BETWEEN SIGNS
- L = LENGTH OF TAPER
- B = LENGTH OF LONGITUDINAL BUFFER SPACE
- D = SPACING BETWEEN CHANNELIZATION DEVICES
- = POLYPOSTS
- = PLASTIC DRUMS

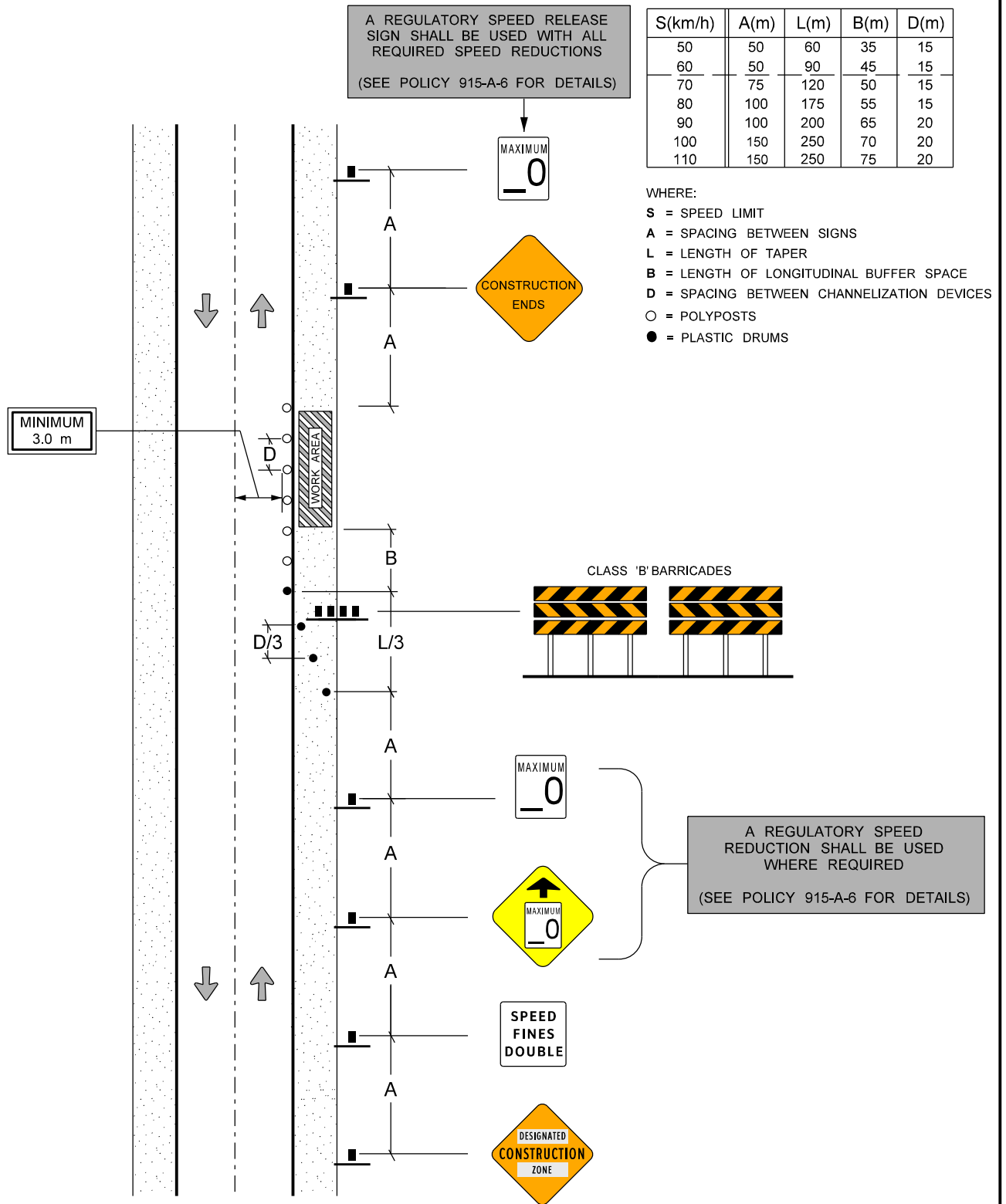

NOTE:

TRAFFIC CONTROL IS SHOWN FOR ONE DIRECTION ONLY. IDENTICAL SIGNING TO BE PROVIDED FOR TRAFFIC IN THE OPPOSING DIRECTION.

LEFT SHOULDER WORK

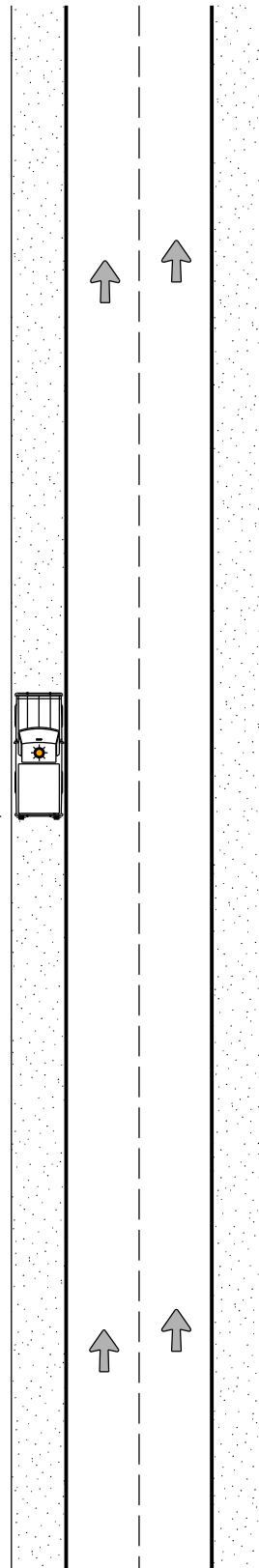
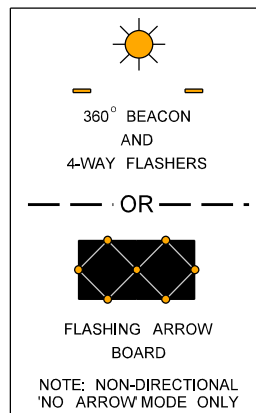

LEFT SHOULDER WORK

S(km/h)	A(m)	L(m)	B(m)	D(m)
50	50	60	35	15
60	50	90	45	15
70	75	120	50	15
80	100	175	55	15
90	100	200	65	20
100	150	250	70	20
110	150	250	75	20

A REGULATORY SPEED RELEASE SIGN SHALL BE USED WITH ALL REQUIRED SPEED REDUCTIONS
(SEE POLICY 915-A-6 FOR DETAILS)

WHERE:
S = SPEED LIMIT
A = SPACING BETWEEN SIGNS
L = LENGTH OF TAPER
B = LENGTH OF LONGITUDINAL BUFFER SPACE
D = SPACING BETWEEN CHANNELIZATION DEVICES
O = POLYPOSTS

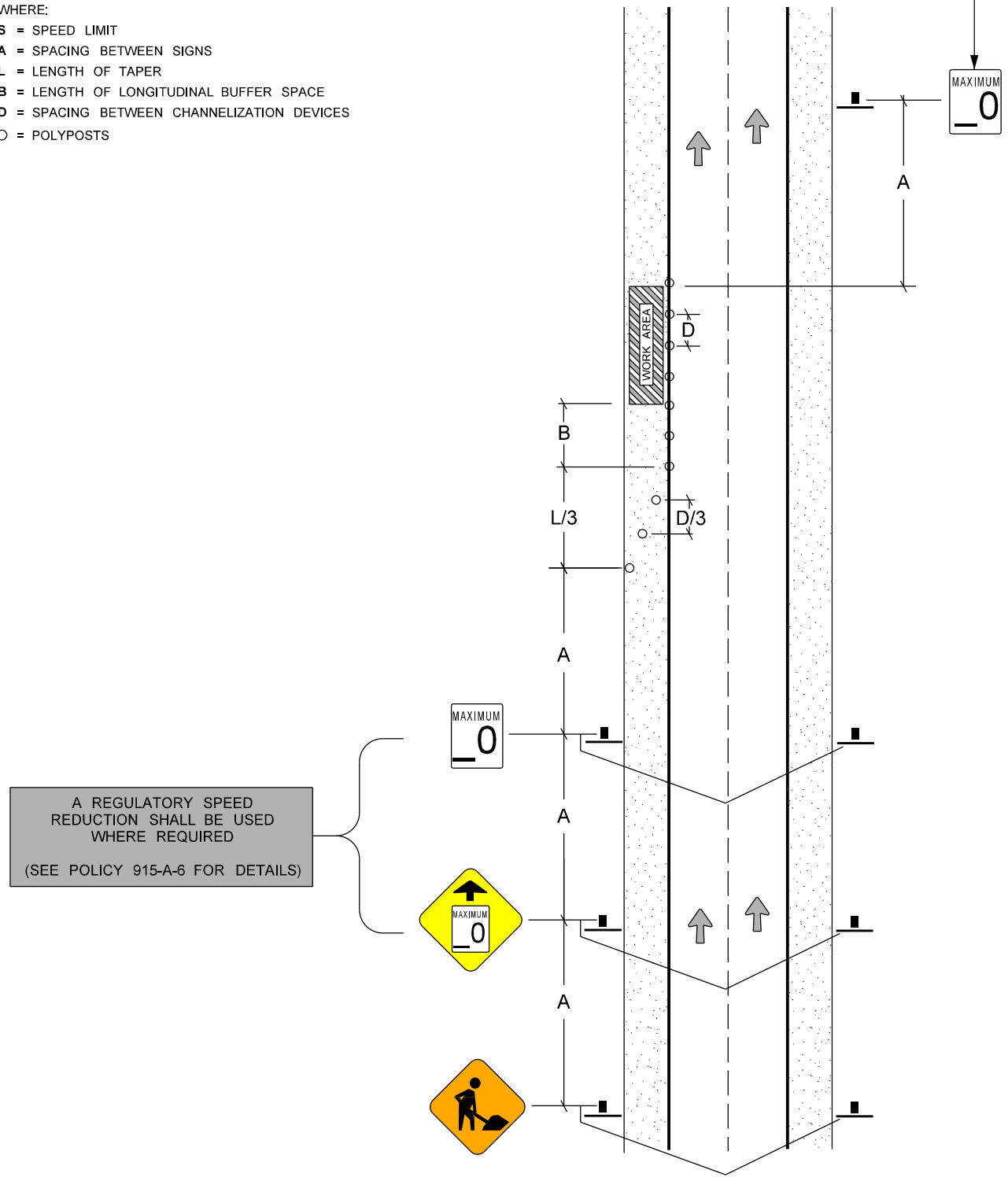

LEFT SHOULDER WORK

S(km/h)	A(m)	L(m)	B(m)	D(m)
50	50	60	35	15
60	50	90	45	15
70	75	120	50	15
80	100	175	55	15
90	100	200	65	20
100	150	250	70	20
110	150	250	75	20

A REGULATORY SPEED RELEASE SIGN SHALL BE USED WITH ALL REQUIRED SPEED REDUCTIONS
(SEE POLICY 915-A-6 FOR DETAILS)

WHERE:



- S = SPEED LIMIT
- A = SPACING BETWEEN SIGNS
- L = LENGTH OF TAPER
- B = LENGTH OF LONGITUDINAL BUFFER SPACE
- D = SPACING BETWEEN DELINEATION DEVICES
- = POLYPOSTS
- = PLASTIC DRUMS

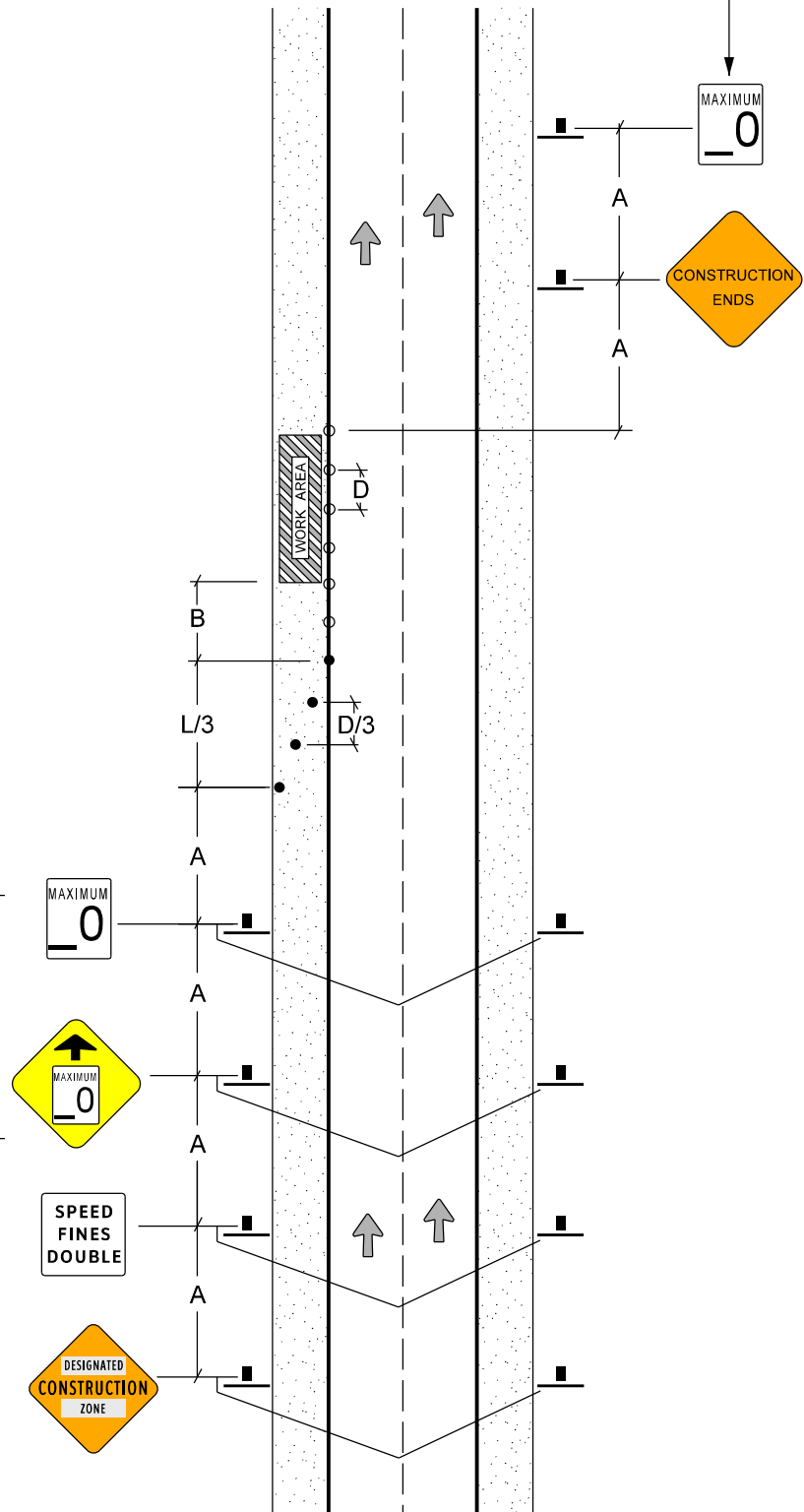

A REGULATORY SPEED REDUCTION SHALL BE USED WHERE REQUIRED
(SEE POLICY 915-A-6 FOR DETAILS)

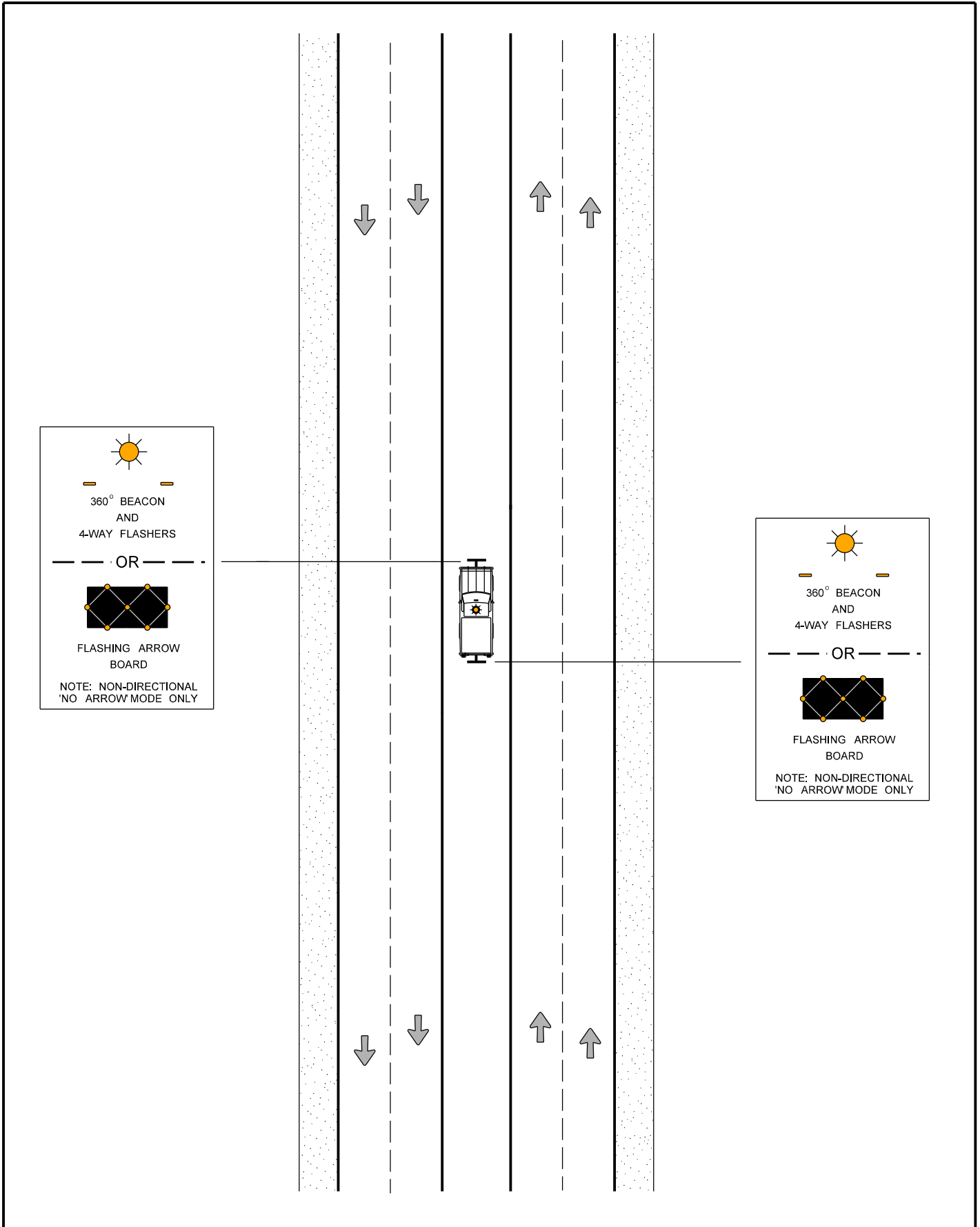

WORK IN MEDIAN



 360° BEACON
 AND
 4-WAY FLASHERS
 — OR —

 FLASHING ARROW
 BOARD
 NOTE: NON-DIRECTIONAL
 'NO ARROW' MODE ONLY

 360° BEACON
 AND
 4-WAY FLASHERS
 — OR —

 FLASHING ARROW
 BOARD
 NOTE: NON-DIRECTIONAL
 'NO ARROW' MODE ONLY

WORK IN MEDIAN

S(km/h)	A(m)	L(m)	B(m)	D(m)
50	50	60	35	15
60	50	90	45	15
70	75	120	50	15
80	100	175	55	15
90	100	200	65	20
100	150	250	70	20
110	150	250	75	20

WHERE:

- S = SPEED LIMIT
- A = SPACING BETWEEN SIGNS
- L = LENGTH OF TAPER
- B = LENGTH OF LONGITUDINAL BUFFER SPACE
- D = SPACING BETWEEN DELINEATION DEVICES
- O = POLYPOSTS

IF DISTANCE IS LESS THAN 12m, INSTALL IDENTICAL SIGNING AND DELINEATION FOR OPPOSITE DIRECTION

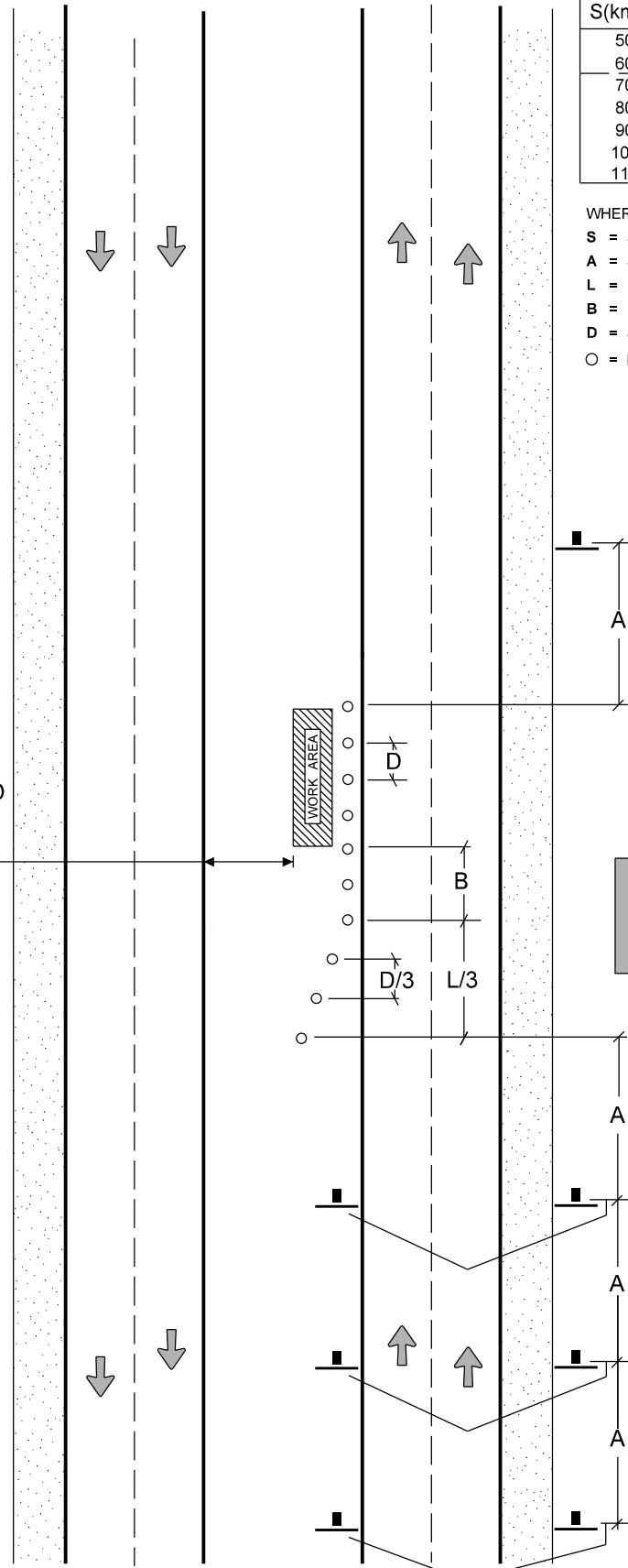

A REGULATORY SPEED RELEASE SIGN SHALL BE USED WITH ALL REQUIRED SPEED REDUCTIONS
(SEE POLICY 915-A-6 FOR DETAILS)

A REGULATORY SPEED REDUCTION SHALL BE USED WHERE REQUIRED
(SEE POLICY 915-A-6 FOR DETAILS)

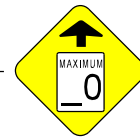

WORK IN MEDIAN

S(km/h)	A(m)	L(m)	B(m)	D(m)
50	50	60	35	15
60	50	90	45	15
70	75	120	50	15
80	100	175	55	15
90	100	200	65	20
100	150	250	70	20
110	150	250	75	20

WHERE:

- S = SPEED LIMIT
- A = SPACING BETWEEN SIGNS
- L = LENGTH OF TAPER
- B = LENGTH OF LONGITUDINAL BUFFER SPACE
- D = SPACING BETWEEN DELINEATION DEVICES
- = POLYPOSTS
- = PLASTIC DRUMS

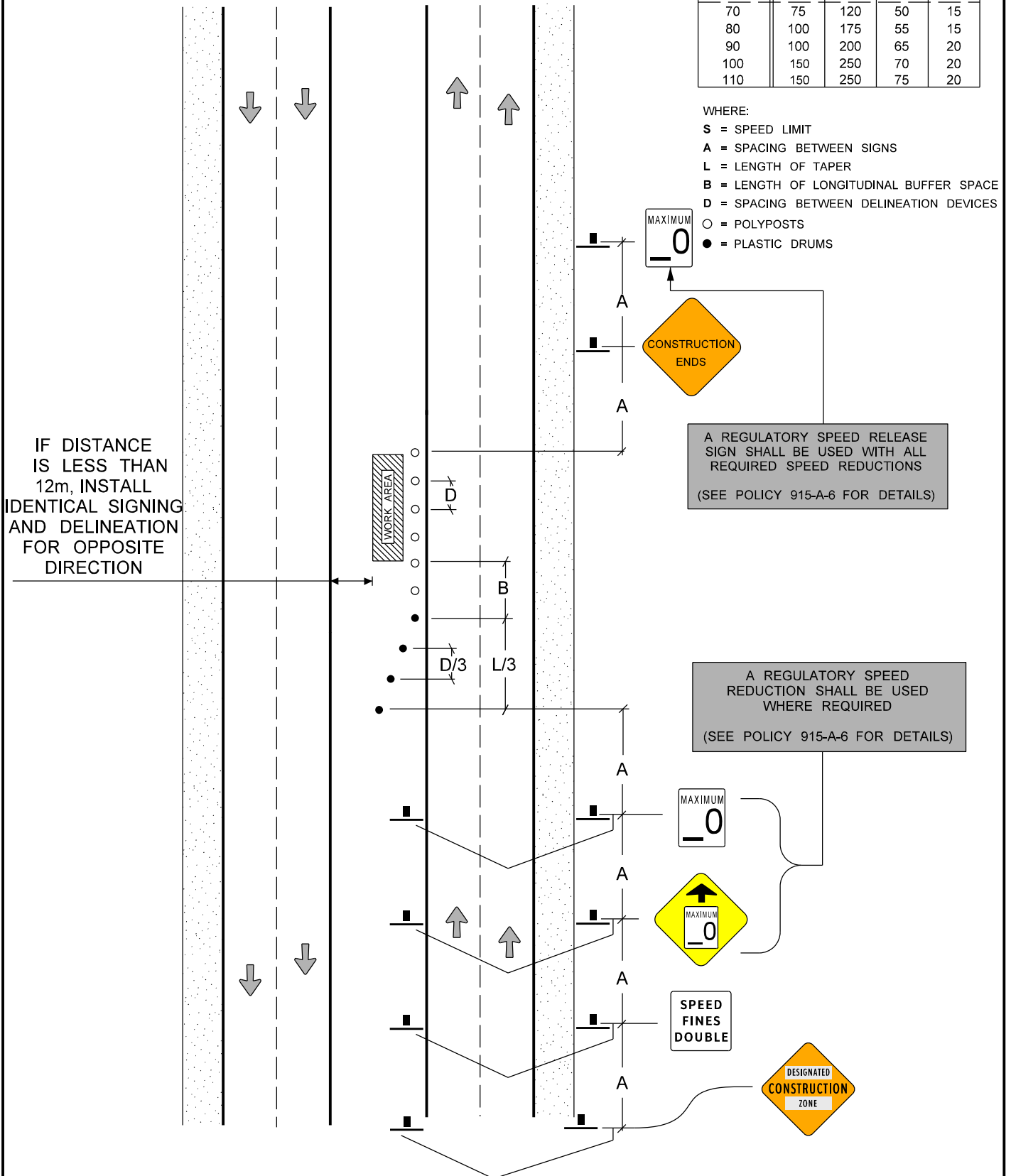

ENCROACHMENT IN LEFT LANE

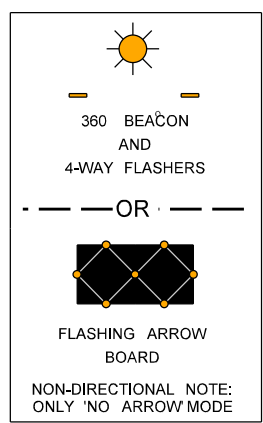
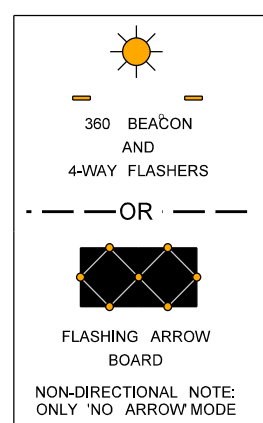

OPTIONAL CRASH ATTENUATOR

ROLL AHEAD DISTANCE
 100m(MIN)

MINIMUM
 3.0 m

MINIMUM
 3.0 m

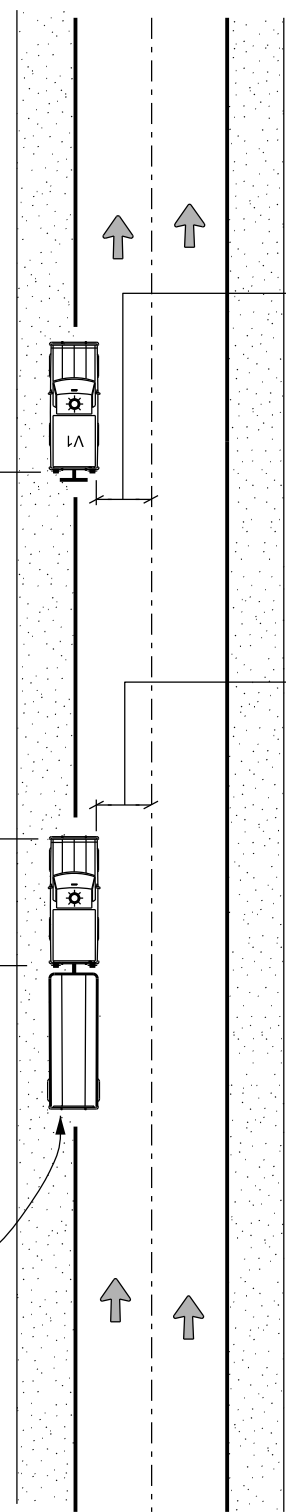

LEGEND	
V1	= WORK TRUCK
V2	= BUFFER TRUCK

ENCROACHMENT IN LEFT LANE

S(km/h)	A(m)	L(m)	B(m)	D(m)
50	50	60	35	15
60	50	90	45	15
70	75	120	50	15
80	100	175	55	15
90	100	200	65	20
100	150	250	70	20
110	150	250	75	20

WHERE:

S = SPEED LIMIT

A = SPACING BETWEEN SIGNS

L = LENGTH OF TAPER

B = LENGTH OF LONGITUDINAL BUFFER SPACE

D = SPACING BETWEEN DELINEATION DEVICES

O = POLYPOSTS

A REGULATORY SPEED REDUCTION SHALL BE USED WHERE REQUIRED
(SEE POLICY 915-A-6 FOR DETAILS)

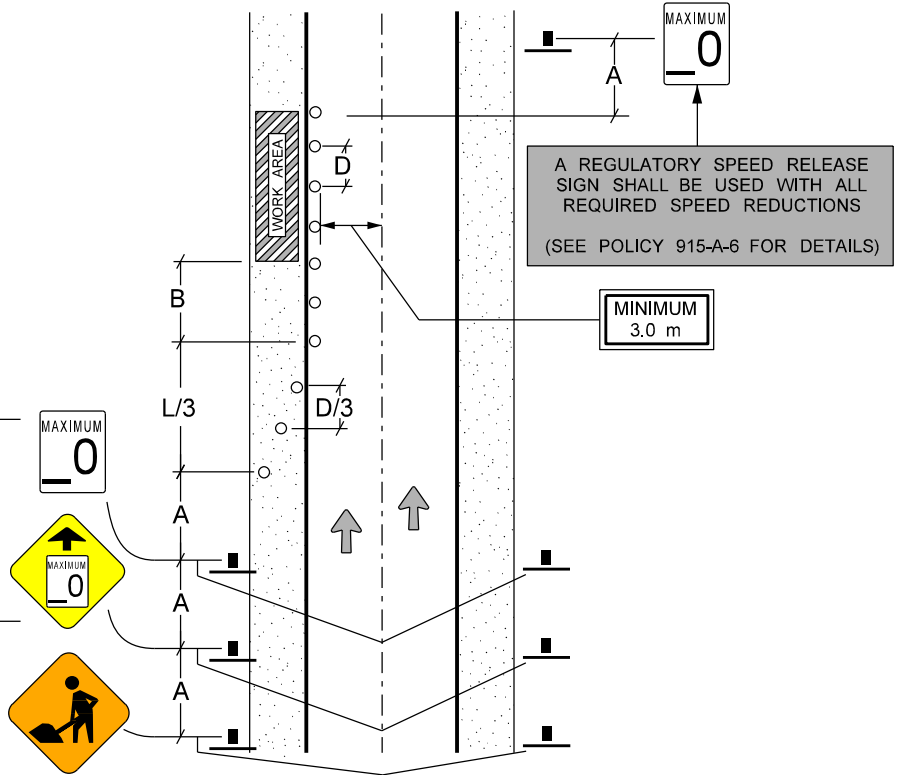

OR

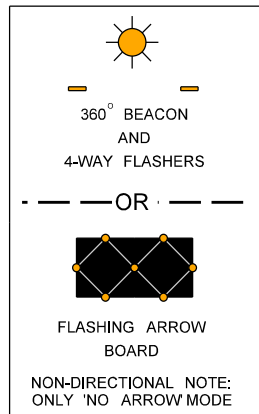

A REGULATORY SPEED REDUCTION SHALL BE USED WHERE REQUIRED
(SEE POLICY 915-A-6 FOR DETAILS)

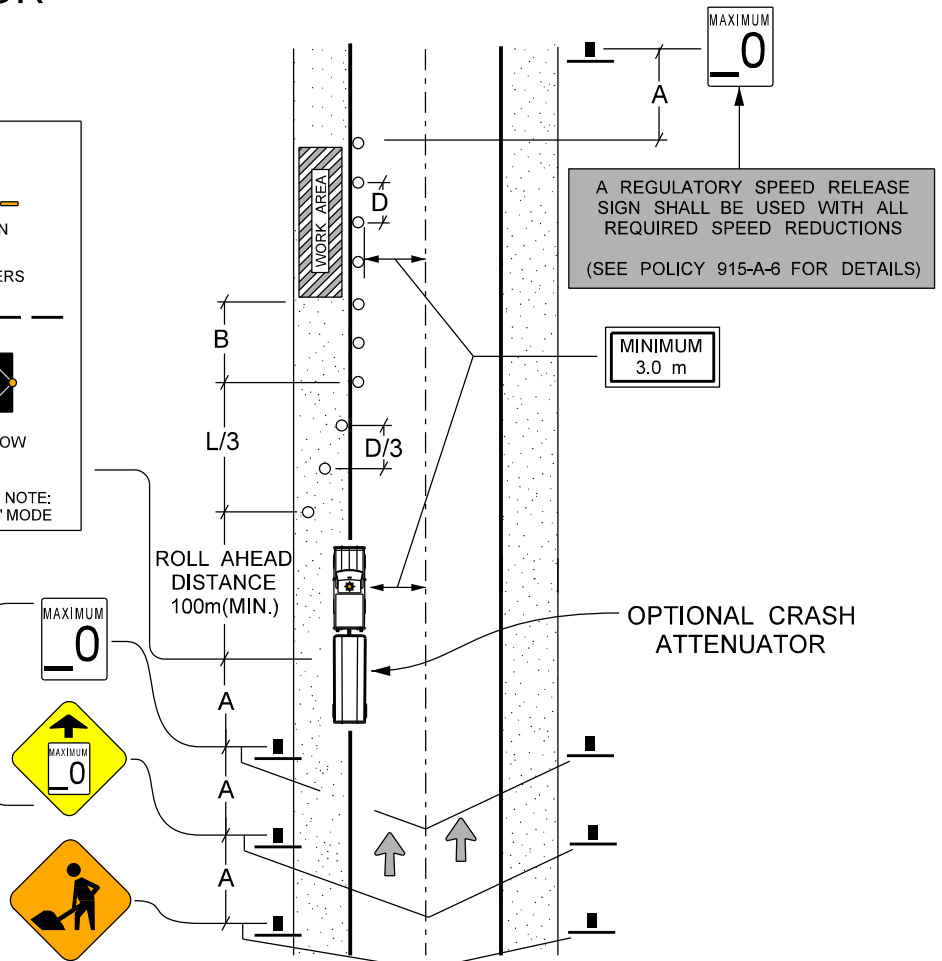

ENCROACHMENT IN LEFT LANE

S(km/h)	A(m)	L(m)	B(m)	D(m)
50	50	60	35	15
60	50	90	45	15
70	75	120	50	15
80	100	175	55	15
90	100	200	65	20
100	150	250	70	20
110	150	250	75	20

A REGULATORY SPEED RELEASE SIGN SHALL BE USED WITH ALL REQUIRED SPEED REDUCTIONS
 (SEE POLICY 915-A-6 FOR DETAILS)

WHERE:

- S = SPEED LIMIT
- A = SPACING BETWEEN SIGNS
- L = LENGTH OF TAPER
- B = LENGTH OF LONGITUDINAL BUFFER SPACE
- D = SPACING BETWEEN CHANNELIZATION DEVICES
- = POLYPOSTS
- = PLASTIC DRUMS

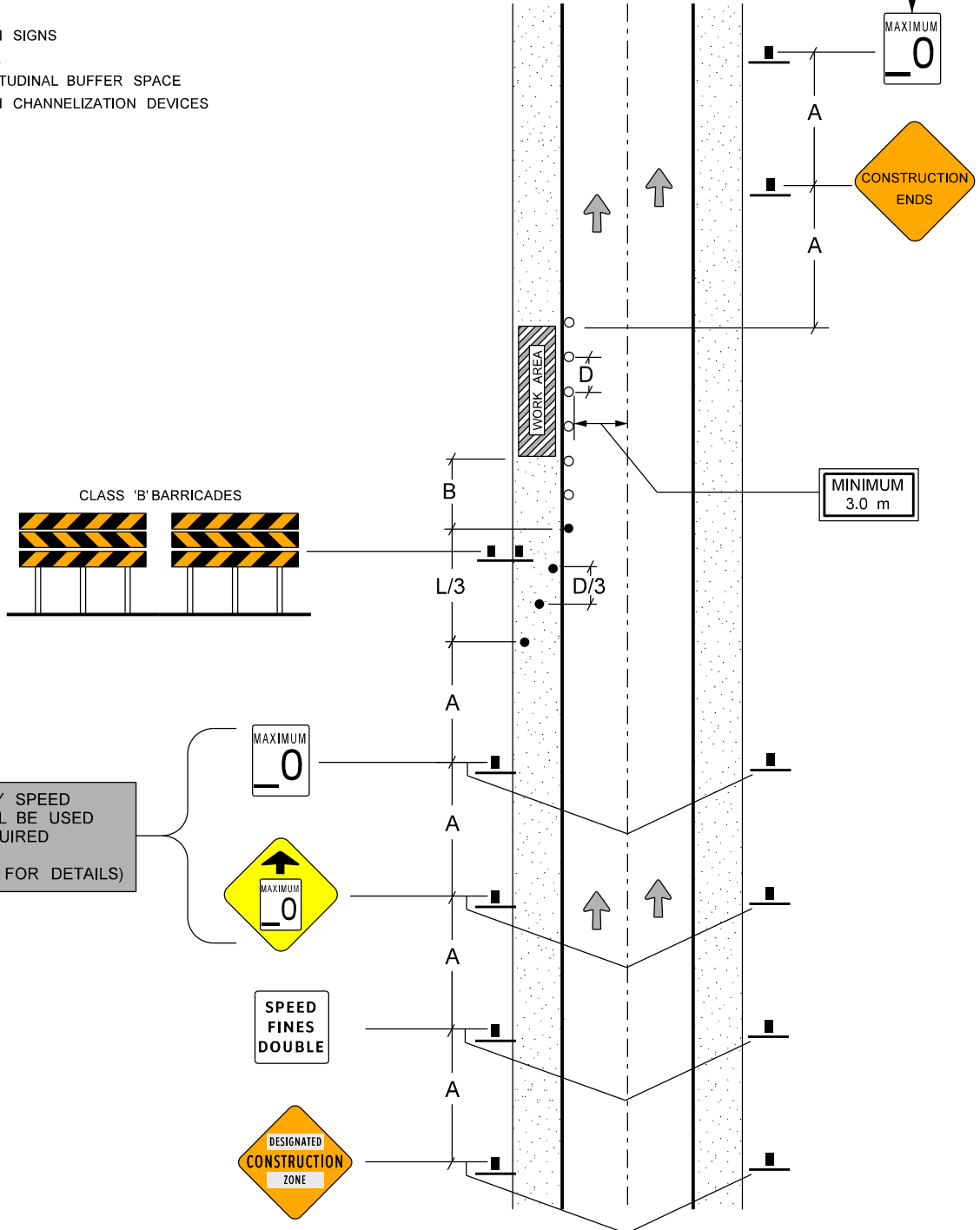

A REGULATORY SPEED REDUCTION SHALL BE USED WHERE REQUIRED
 (SEE POLICY 915-A-6 FOR DETAILS)

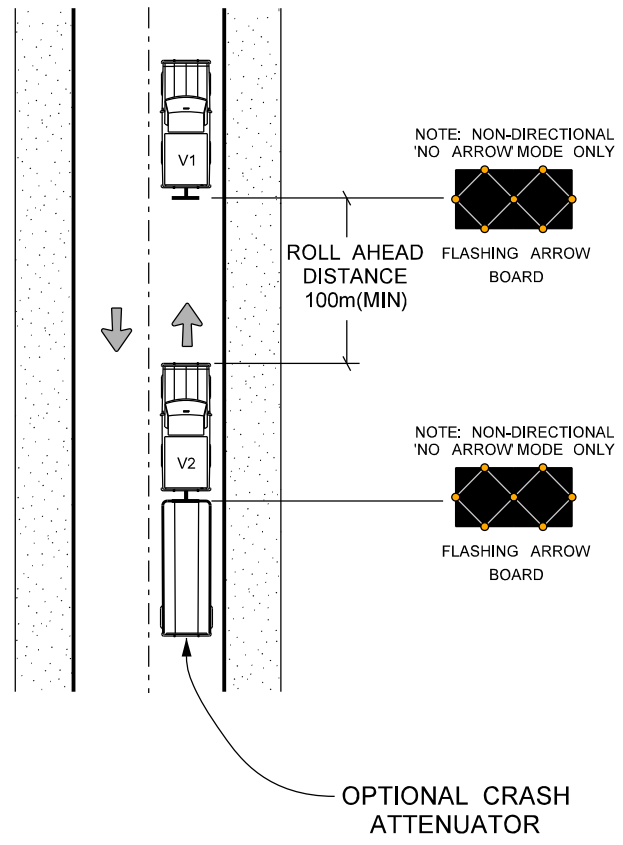

LEGEND	
V1	= WORK TRUCK
V2	= BUFFER TRUCK

SINGLE LANE CLOSED

TWO-LANE ROAD - YIELD TO ONCOMING TRAFFIC VOLUME < 500 AADT

(SEE POLICY 915-A-6 FOR DETAILS)
A REGULATORY SPEED
REDUCTION SHALL BE USED
WHERE REQUIRED



S(km/h)	A(m)	L(m)	B(m)	D(m)
50	50	60	35	15
60	50	90	45	15
70	75	120	50	15
80	100	175	55	15
90	100	200	65	20
100	150	250	70	20
110	150	250	75	20

WHERE:

- S = SPEED LIMIT
- A = SPACING BETWEEN SIGNS
- L = LENGTH OF TAPER
- B = LENGTH OF LONGITUDINAL BUFFER SPACE
- D = SPACING BETWEEN CHANNELIZATION DEVICES
- O = POLYPOSTS

A REGULATORY SPEED
RELEASE
SIGN SHALL BE USED WITH ALL
REQUIRED SPEED REDUCTIONS
(SEE POLICY 915-A-6 FOR DETAILS)

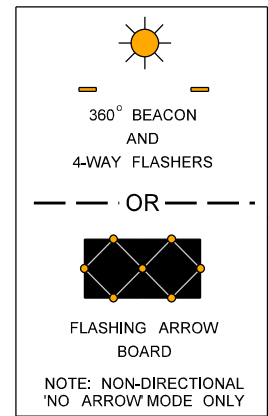

(SEE POLICY 915-A-6 FOR DETAILS)
A REGULATORY SPEED RELEASE
SIGN SHALL BE USED WITH ALL
REQUIRED SPEED REDUCTIONS

A REGULATORY SPEED
REDUCTION SHALL BE USED
WHERE REQUIRED
(SEE POLICY 915-A-6 FOR DETAILS)

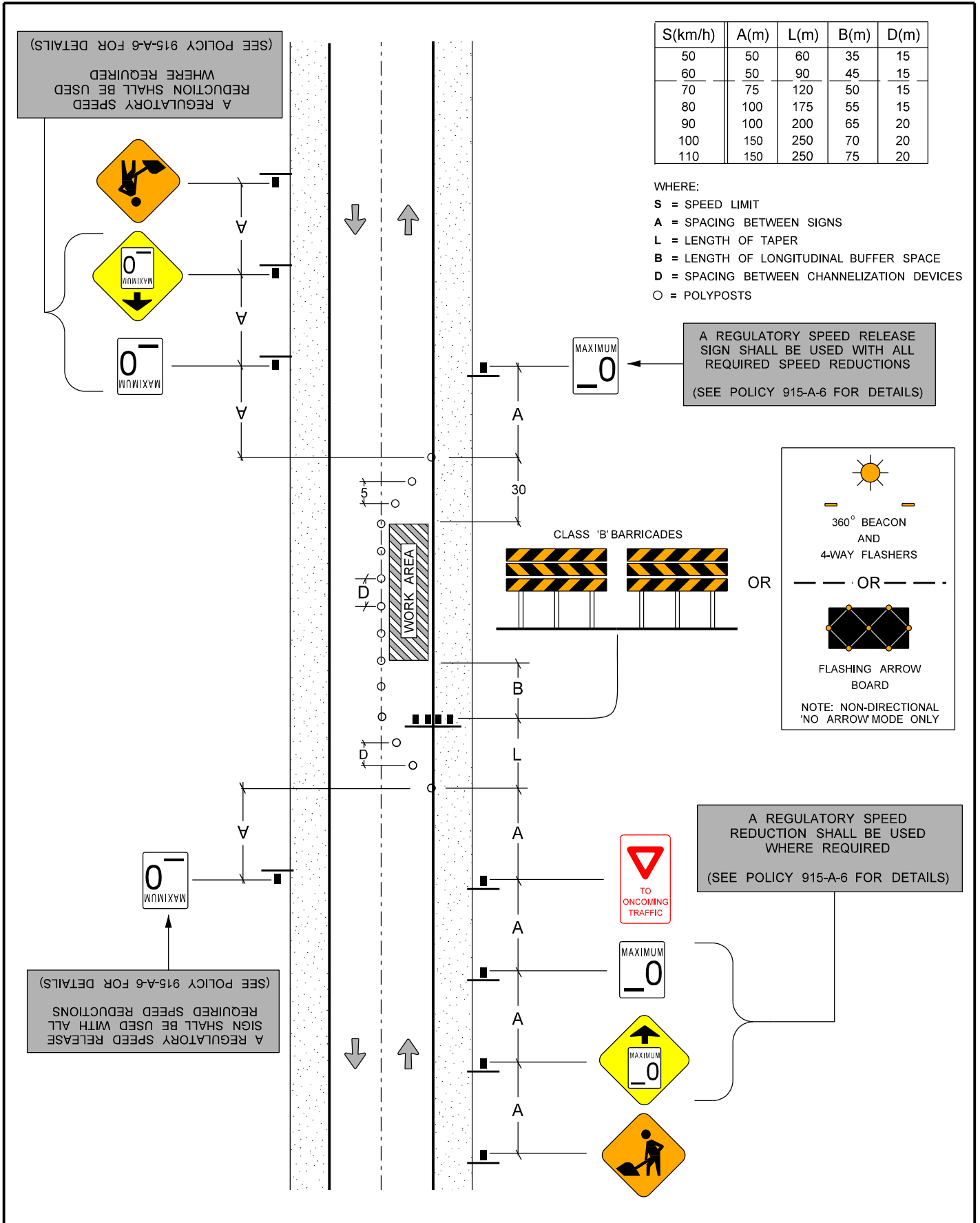

SINGLE LANE CLOSED

TWO-LANE ROAD - YIELD TO ONCOMING TRAFFIC VOLUME < 500 AADT

S(km/h)	A(m)	L(m)	B(m)	D(m)
50	50	60	35	15
60	50	90	45	15
70	75	120	50	15
80	100	175	55	15
90	100	200	65	20
100	150	250	70	20
110	150	250	75	20

WHERE:

- S = SPEED LIMIT
- A = SPACING BETWEEN SIGNS
- L = LENGTH OF TAPER
- B = LENGTH OF LONGITUDINAL BUFFER SPACE
- D = SPACING BETWEEN CHANNELIZATION DEVICES
- = POLYPOSTS
- = PLASTIC DRUMS

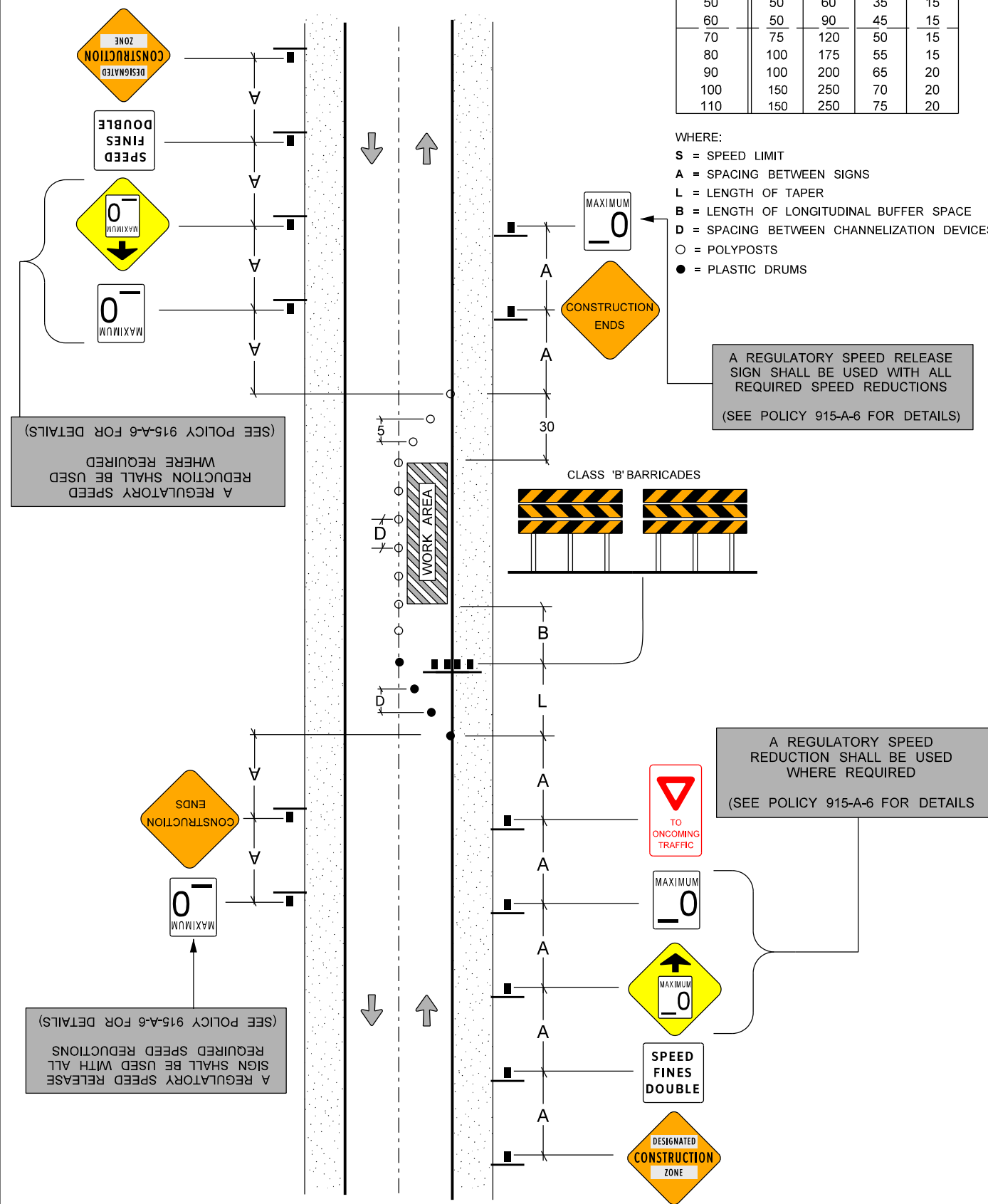

(SEE POLICY 915-A-6 FOR DETAILS)
A REGULATORY SPEED REDUCTION SHALL BE USED WHERE REQUIRED

A REGULATORY SPEED RELEASE SIGN SHALL BE USED WITH ALL REQUIRED SPEED REDUCTIONS
(SEE POLICY 915-A-6 FOR DETAILS)

A REGULATORY SPEED REDUCTION SHALL BE USED WHERE REQUIRED
(SEE POLICY 915-A-6 FOR DETAILS)

S(km/h)	A(m)	L(m)	B(m)	D(m)
50	50	60	35	15
60	50	90	45	15
70	75	120	50	15
80	100	175	55	15
90	100	200	65	20
100	150	250	70	20
110	150	250	75	20

WHERE:

S = SPEED LIMIT

A = SPACING BETWEEN SIGNS

L = LENGTH OF TAPER

B = LENGTH OF LONGITUDINAL BUFFER SPACE

D = SPACING BETWEEN CHANNELIZATION DEVICES

F = SPACING BETWEEN FLAGPERSON SIGN AND FLAGPERSON

O = POLYPOSTS

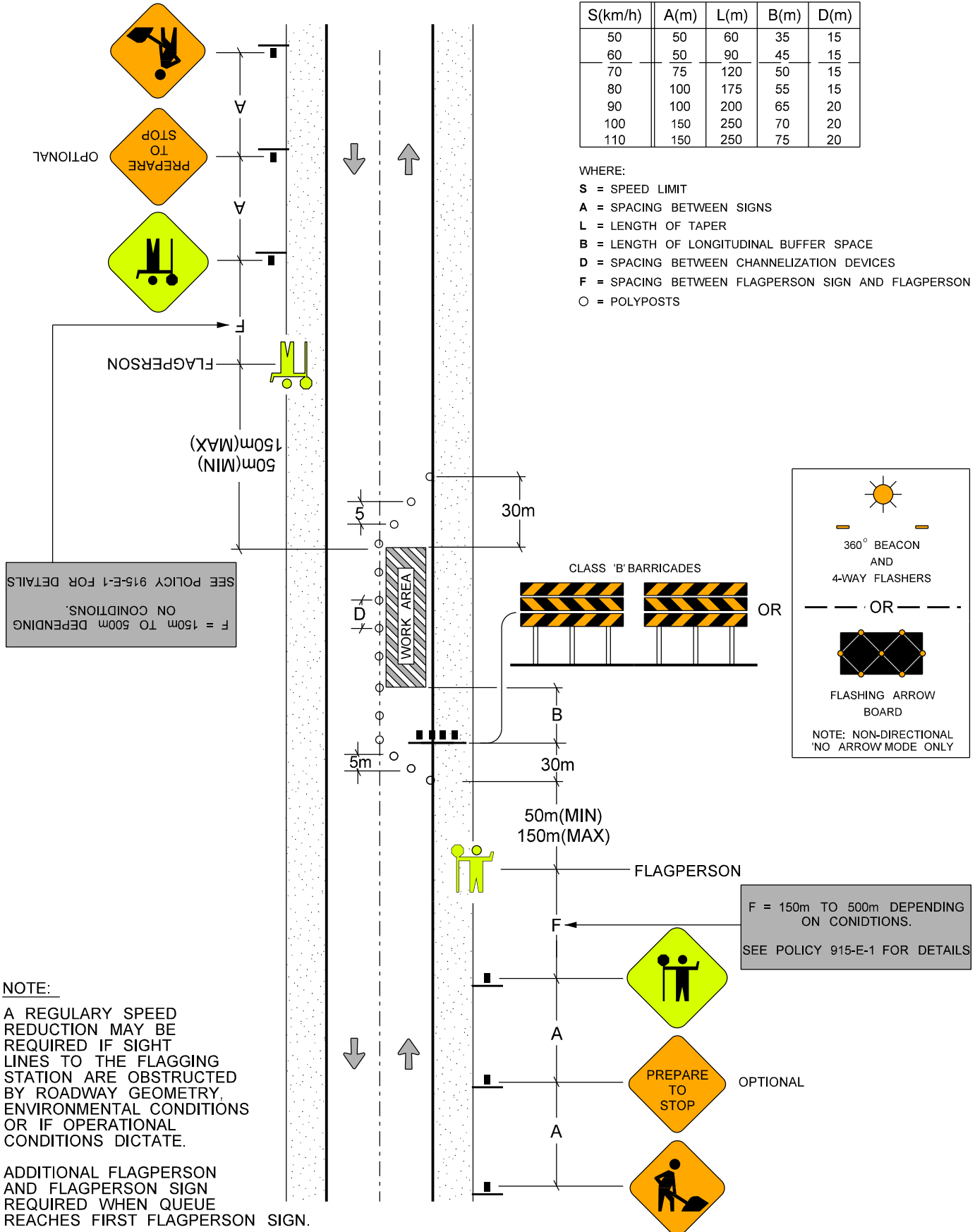

SEE POLICY 915-E-1 FOR DETAILS
ON CONDITIONS.
F = 150m TO 500m DEPENDING

F = 150m TO 500m DEPENDING
ON CONDITIONS.
SEE POLICY 915-E-1 FOR DETAILS

NOTE:
A REGULARY SPEED
REDUCTION MAY BE
REQUIRED IF SIGHT
LINES TO THE FLAGGING
STATION ARE OBSTRUCTED
BY ROADWAY GEOMETRY,
ENVIRONMENTAL CONDITIONS
OR IF OPERATIONAL
CONDITIONS DICTATE.

ADDITIONAL FLAGPERSON
AND FLAGPERSON SIGN
REQUIRED WHEN QUEUE
REACHES FIRST FLAGPERSON SIGN.

SINGLE LANE CLOSED

TWO LANE ROAD - FLAGPERSON - VOLUME 500 - 1000 AADT

S(km/h)	A(m)	L(m)	B(m)	D(m)
50	50	60	35	15
60	50	90	45	15
70	75	120	50	15
80	100	175	55	15
90	100	200	65	20
100	150	250	70	20
110	150	250	75	20

WHERE:

- S = SPEED LIMIT
- A = SPACING BETWEEN SIGNS
- L = LENGTH OF TAPER
- B = LENGTH OF LONGITUDINAL BUFFER SPACE
- D = SPACING BETWEEN CHANNELIZATION DEVICES
- F = SPACING BETWEEN FLAGPERSON SIGN AND FLAGPERSON
- = POLYPOSTS
- = PLASTIC DRUMS

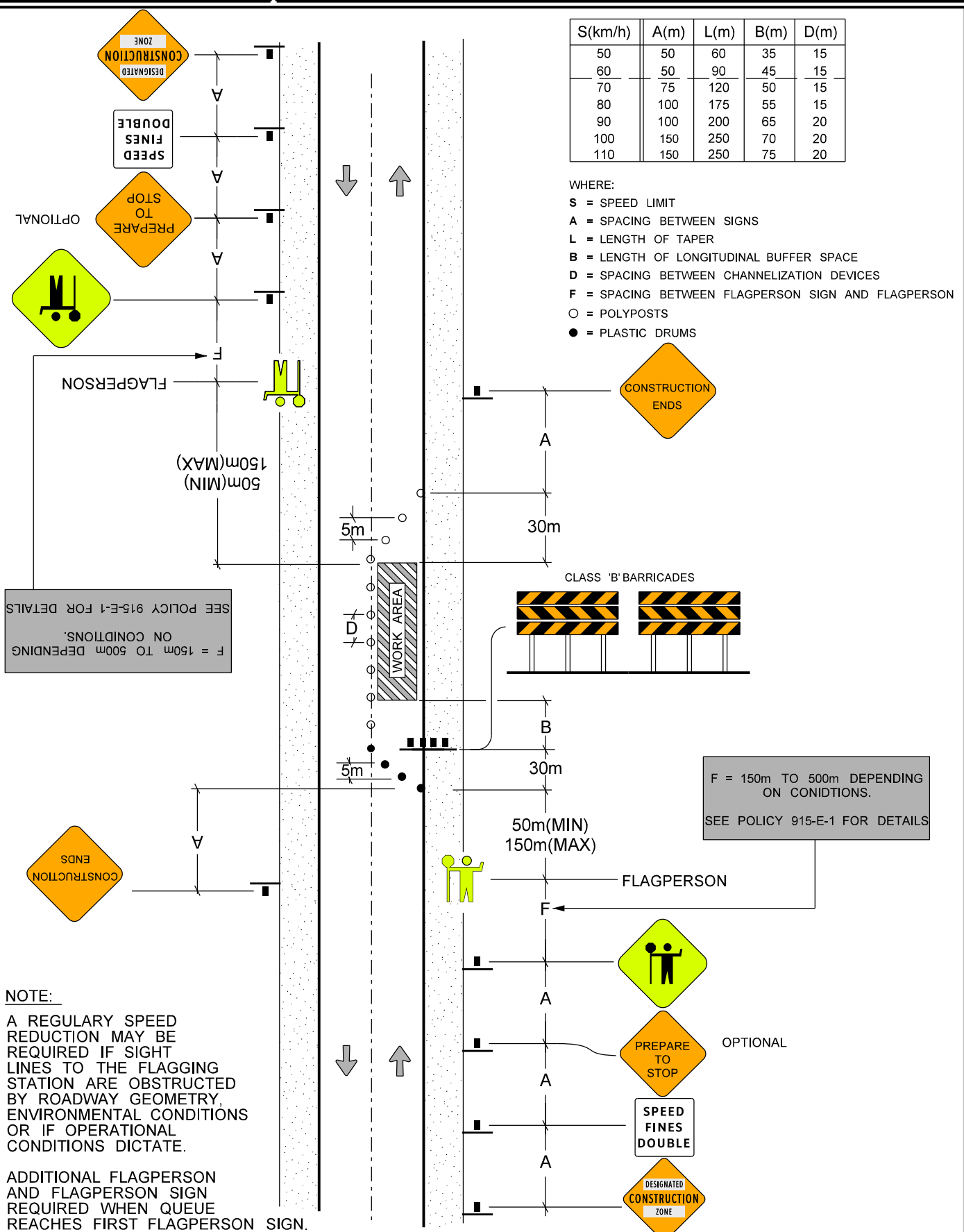

SEE POLICY 915-E-1 FOR DETAILS ON CONDITIONS.
F = 150m TO 500m DEPENDING ON CONDITIONS.

F = 150m TO 500m DEPENDING ON CONDITIONS.
SEE POLICY 915-E-1 FOR DETAILS

NOTE:
A REGULARY SPEED REDUCTION MAY BE REQUIRED IF SIGHT LINES TO THE FLAGGING STATION ARE OBSTRUCTED BY ROADWAY GEOMETRY, ENVIRONMENTAL CONDITIONS OR IF OPERATIONAL CONDITIONS DICTATE.
ADDITIONAL FLAGPERSON AND FLAGPERSON SIGN REQUIRED WHEN QUEUE REACHES FIRST FLAGPERSON SIGN.

SINGLE LANE CLOSED

TWO LANE ROAD - FLAGPERSON - VOLUME > 1000 AADT

S(km/h)	A(m)	L(m)	B(m)	D(m)
50	50	60	35	15
60	50	90	45	15
70	75	120	50	15
80	100	175	55	15
90	100	200	65	20
100	150	250	70	20
110	150	250	75	20

WHERE:

- S = SPEED LIMIT
- A = SPACING BETWEEN SIGNS
- L = LENGTH OF TAPER
- B = LENGTH OF LONGITUDINAL BUFFER SPACE
- D = SPACING BETWEEN CHANNELIZATION DEVICES
- F = SPACING BETWEEN FLAGPERSON SIGN AND FLAGPERSON
- O = POLYPOSTS

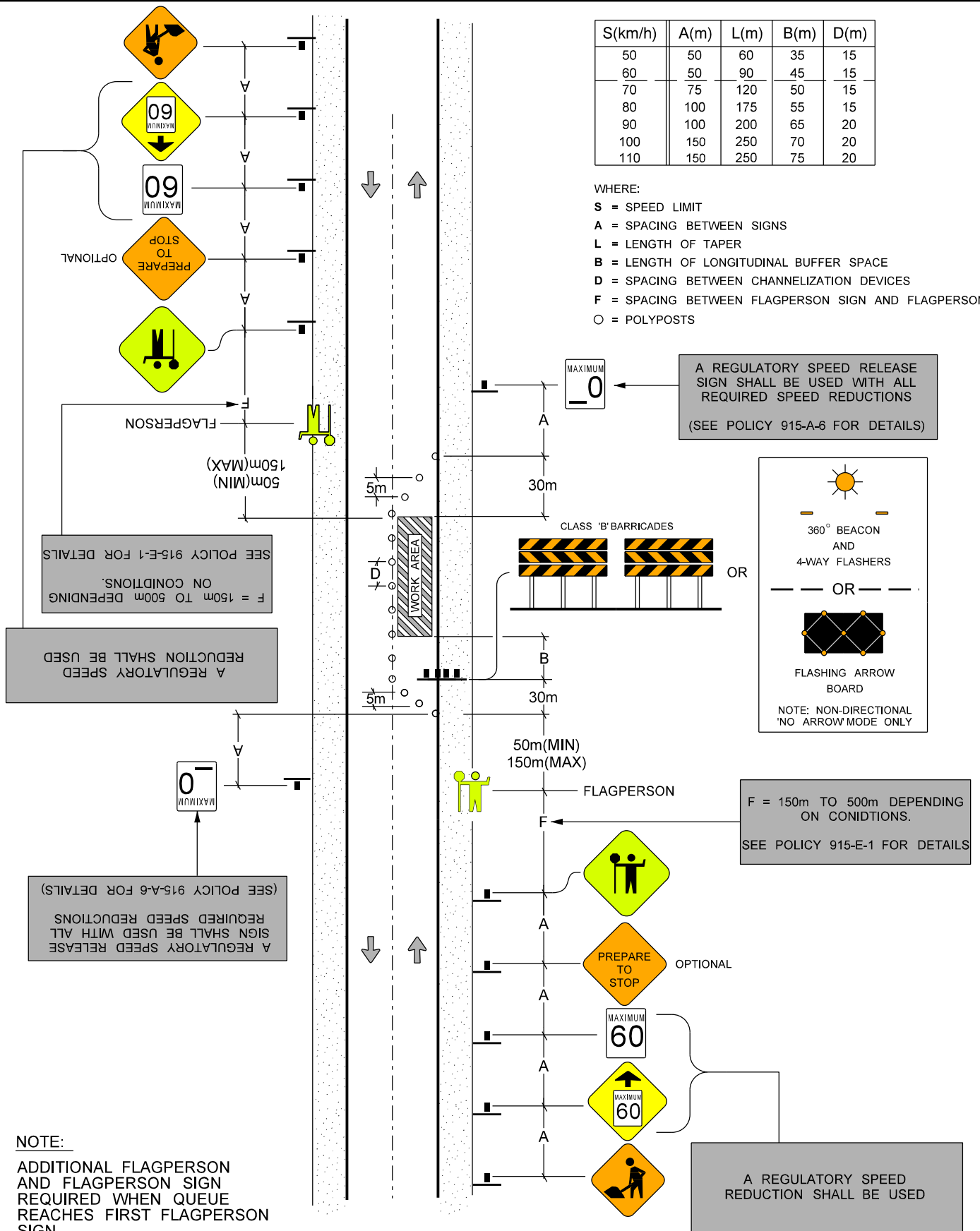

A REGULATORY SPEED RELEASE SIGN SHALL BE USED WITH ALL REQUIRED SPEED REDUCTIONS
(SEE POLICY 915-A-6 FOR DETAILS)

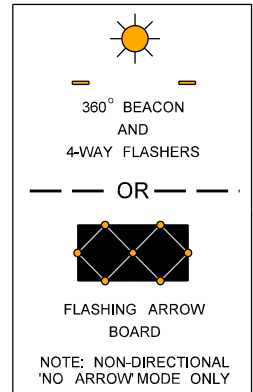

F = 150m TO 500m DEPENDING ON CONDITIONS.
SEE POLICY 915-E-1 FOR DETAILS

A REGULATORY SPEED REDUCTION SHALL BE USED
F = 150m TO 500m DEPENDING ON CONDITIONS.
SEE POLICY 915-E-1 FOR DETAILS

A REGULATORY SPEED RELEASE SIGN SHALL BE USED WITH ALL REQUIRED SPEED REDUCTIONS
(SEE POLICY 915-A-6 FOR DETAILS)

A REGULATORY SPEED REDUCTION SHALL BE USED

NOTE:
ADDITIONAL FLAGPERSON AND FLAGPERSON SIGN REQUIRED WHEN QUEUE REACHES FIRST FLAGPERSON SIGN.

SINGLE LANE CLOSED

TWO LANE ROAD - FLAGPERSON - VOLUME > 1000 AADT

S(km/h)	A(m)	L(m)	B(m)	D(m)
50	50	60	35	15
60	50	90	45	15
70	75	120	50	15
80	100	175	55	15
90	100	200	65	20
100	150	250	70	20
110	150	250	75	20

WHERE:

- S = SPEED LIMIT
- A = SPACING BETWEEN SIGNS
- L = LENGTH OF TAPER
- B = LENGTH OF LONGITUDINAL BUFFER SPACE
- D = SPACING BETWEEN CHANNELIZATION DEVICES
- F = SPACING BETWEEN FLAGPERSON SIGN AND FLAGPERSON
- = POLYPOSTS
- = PLASTIC DRUMS

A REGULATORY SPEED RELEASE SIGN SHALL BE USED WITH ALL REQUIRED SPEED REDUCTIONS
(SEE POLICY 915-A-6 FOR DETAILS)

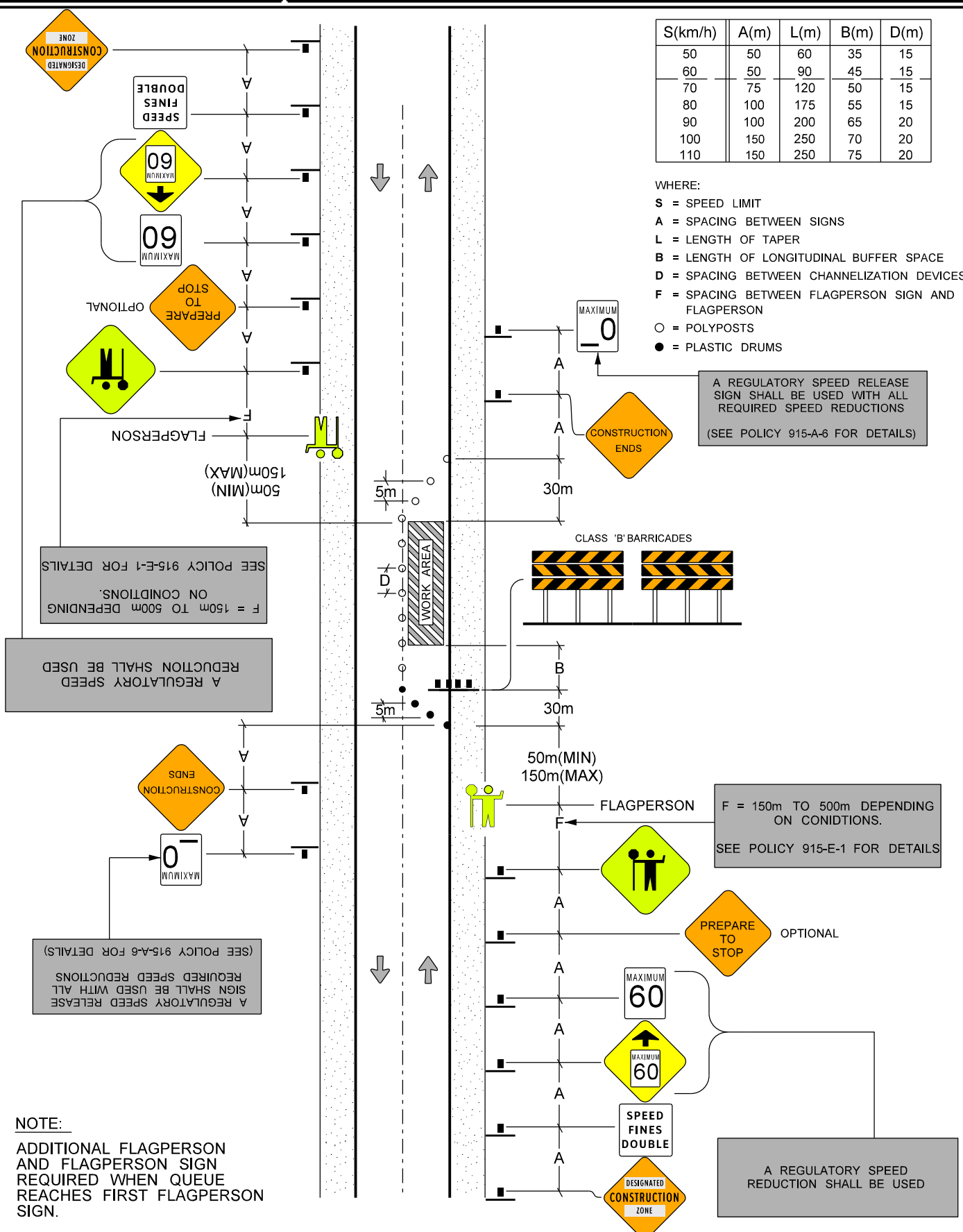

SEE POLICY 915-E-1 FOR DETAILS ON CONDITIONS.
F = 150m TO 500m DEPENDING ON CONDITIONS.

A REGULATORY SPEED REDUCTION SHALL BE USED

F = 150m TO 500m DEPENDING ON CONDITIONS.
SEE POLICY 915-E-1 FOR DETAILS

A REGULATORY SPEED RELEASE SIGN SHALL BE USED WITH ALL REQUIRED SPEED REDUCTIONS
(SEE POLICY 915-A-6 FOR DETAILS)

A REGULATORY SPEED REDUCTION SHALL BE USED

NOTE:

ADDITIONAL FLAGPERSON AND FLAGPERSON SIGN REQUIRED WHEN QUEUE REACHES FIRST FLAGPERSON SIGN.

NOTES:

- IF 'MAX WIDTH' SIGNS ARE REQUIRED AT WORK AREA, ADDITIONAL SIGNS SHALL ALSO BE INSTALLED AT NEAREST ALTERNATE INTERSECTION FOR ADVANCE WARNINGS.
- ILLUMINATION SHALL BE REQUIRED FOR ALL TRAFFIC SIGNAL INSTALLATIONS.

S(km/h)	A(m)
50	50
60	50
70	75
80	100
90	100
100	150
110	150

WHERE:
 S = SPEED LIMIT
 A = SPACING BETWEEN SIGNS
 ● = PLASTIC DRUMS
 ○ = POLYPOSTS

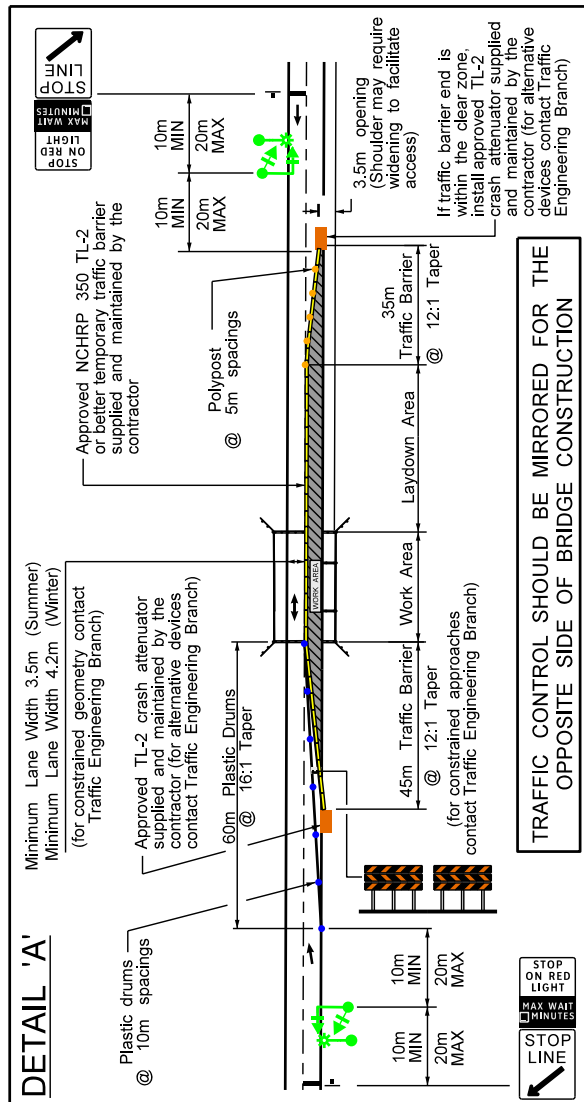

TRAFFIC CONTROL SHOULD BE MIRRORED FOR THE OPPOSITE SIDE OF BRIDGE CONSTRUCTION

A REGULATORY SPEED REDUCTION SHALL BE USED

REQUIRED ON ALL ROADS WITH A MINIMUM LANE WIDTH OF 4.2M OR LESS

LOCATION FOR TC-13L SIGN DURING OPPOSITE LANE WORK

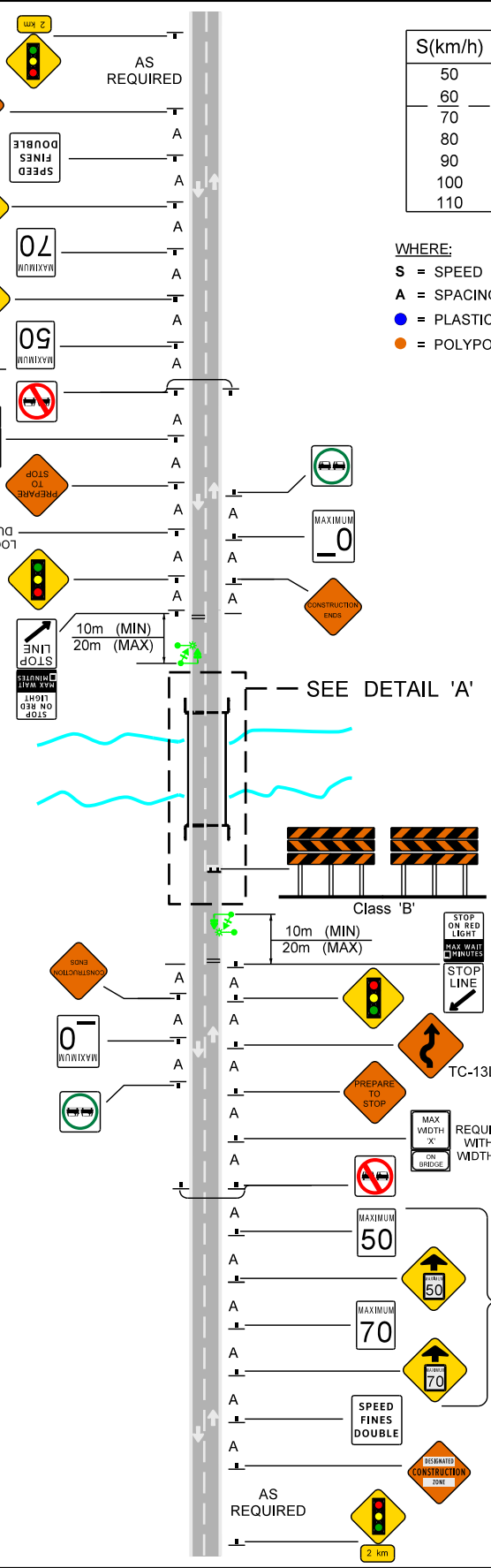

A REGULATORY SPEED REDUCTION SHALL BE USED

SINGLE LANE CLOSED

USE SHOULDER

S(km/h)	A(m)	L(m)	B(m)	D(m)
50	50	60	35	15
60	50	90	45	15
70	75	120	50	15
80	100	175	55	15
90	100	200	65	20
100	150	250	70	20
110	150	250	75	20

WHERE:

- S = SPEED LIMIT
- A = SPACING BETWEEN SIGNS
- L = LENGTH OF TAPER
- B = LENGTH OF LONGITUDINAL BUFFER SPACE
- D = SPACING BETWEEN CHANNELIZATION DEVICES
- = POLYPOSTS
- = PLASTIC DRUMS

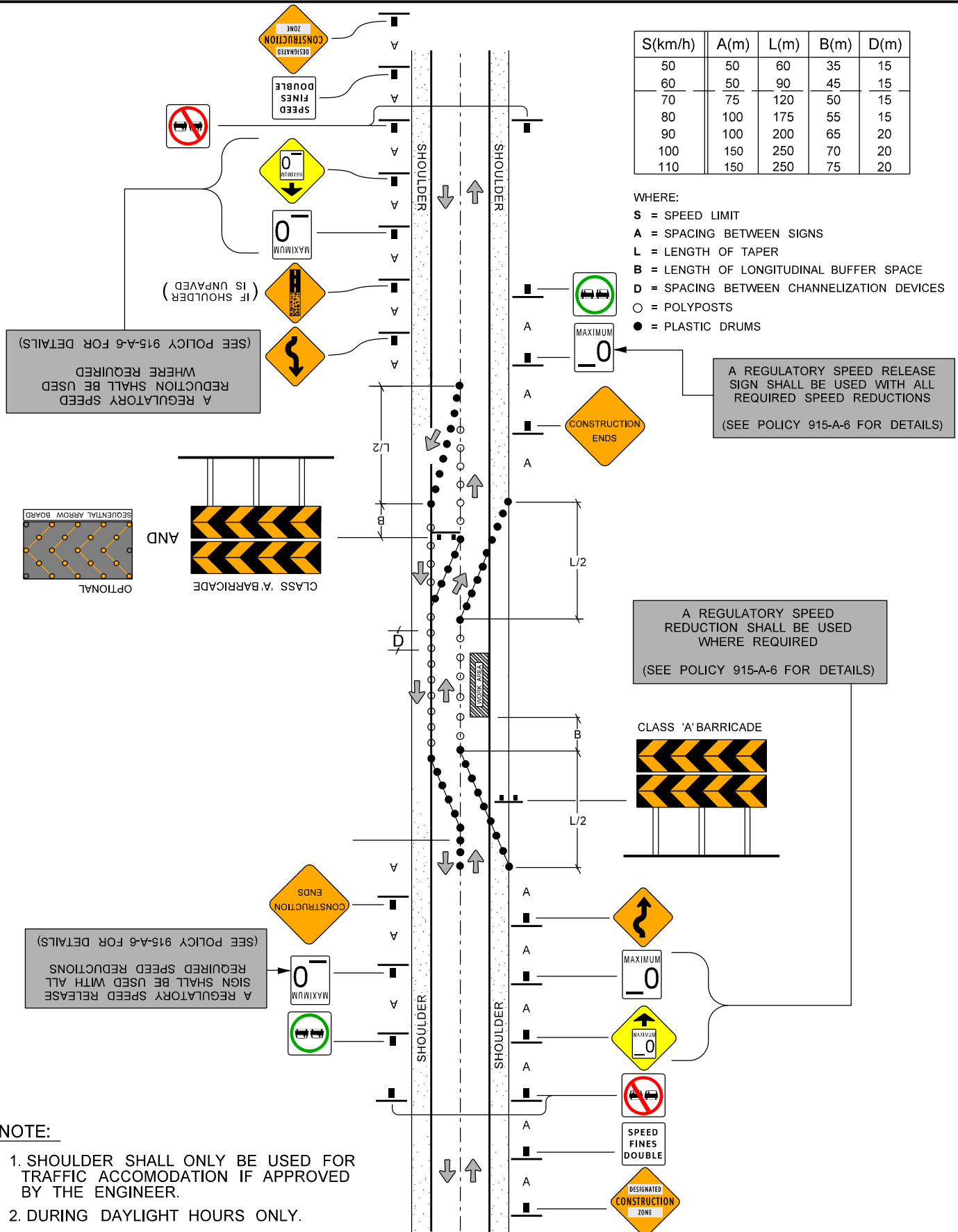

NOTE:

1. SHOULDER SHALL ONLY BE USED FOR TRAFFIC ACCOMODATION IF APPROVED BY THE ENGINEER.
2. DURING DAYLIGHT HOURS ONLY.

SINGLE LANE CLOSED

MOBILE WORK
(LESS THAN 5 MINUTES)

MULTI-LANE ROAD

S(km/h)	A(m)	L(m)	B(m)	D(m)
50	50	60	35	15
60	50	90	45	15
70	75	120	50	15
80	100	175	55	15
90	100	200	65	20
100	150	250	70	20
110	150	250	75	20

WHERE:

S = SPEED LIMIT

A = SPACING BETWEEN SIGNS

L = LENGTH OF TAPER

B = LENGTH OF LONGITUDINAL BUFFER SPACE

D = SPACING BETWEEN CHANNELIZATION DEVICES

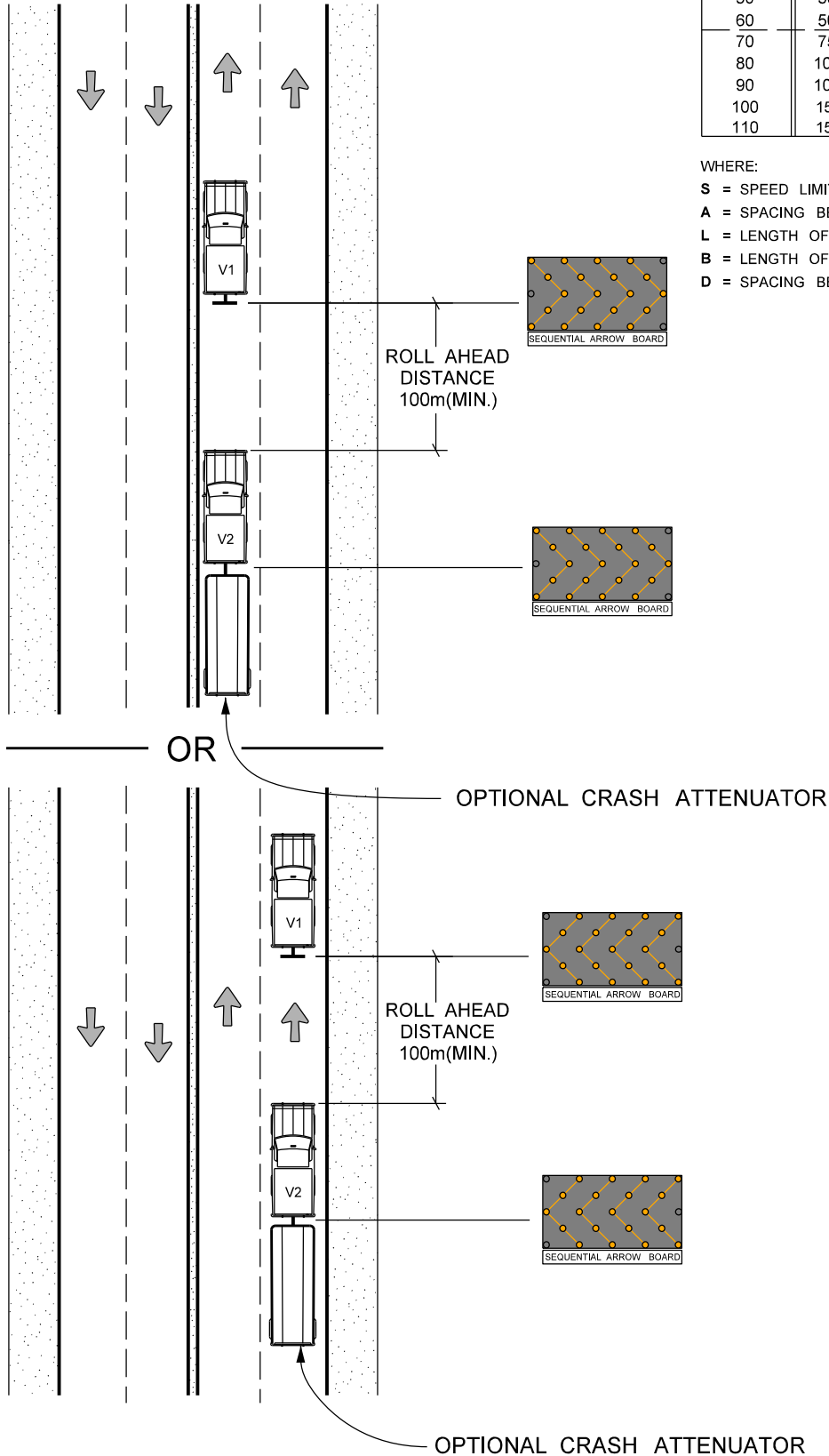

LEGEND	
V1	= WORK TRUCK
V2	= BUFFER TRUCK

SINGLE LANE CLOSED

MULTI-LANE ROAD - LEFT LANE CLOSED

S(km/h)	A(m)	L(m)	B(m)	D(m)
50	50	60	35	15
60	50	90	45	15
70	75	120	50	15
80	100	175	55	15
90	100	200	65	20
100	150	250	70	20
110	150	250	75	20

WHERE:

S = SPEED LIMIT

A = SPACING BETWEEN SIGNS

L = LENGTH OF TAPER

B = LENGTH OF LONGITUDINAL BUFFER SPACE

D = SPACING BETWEEN CHANNELIZATION DEVICES

O = POLYPOSTS

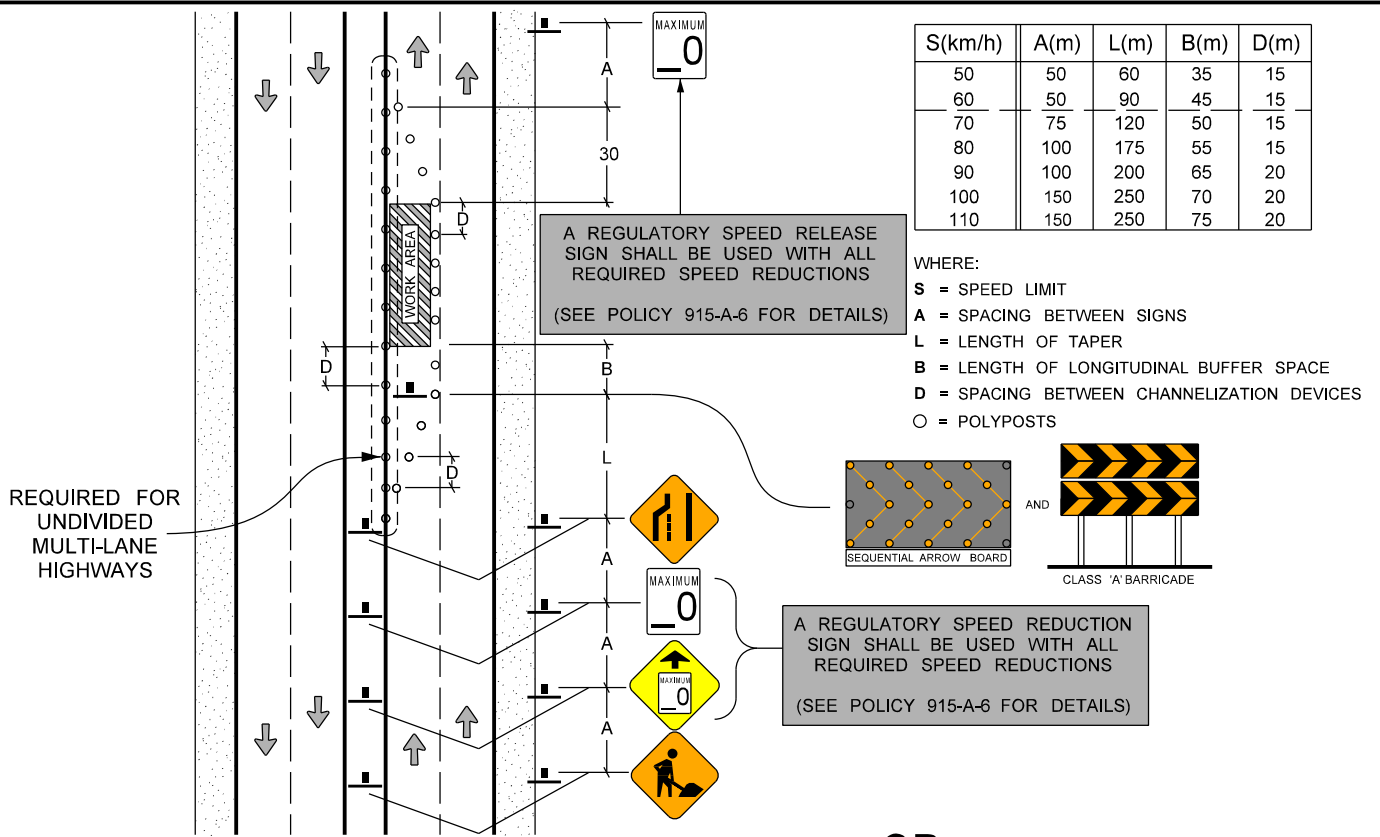

OR

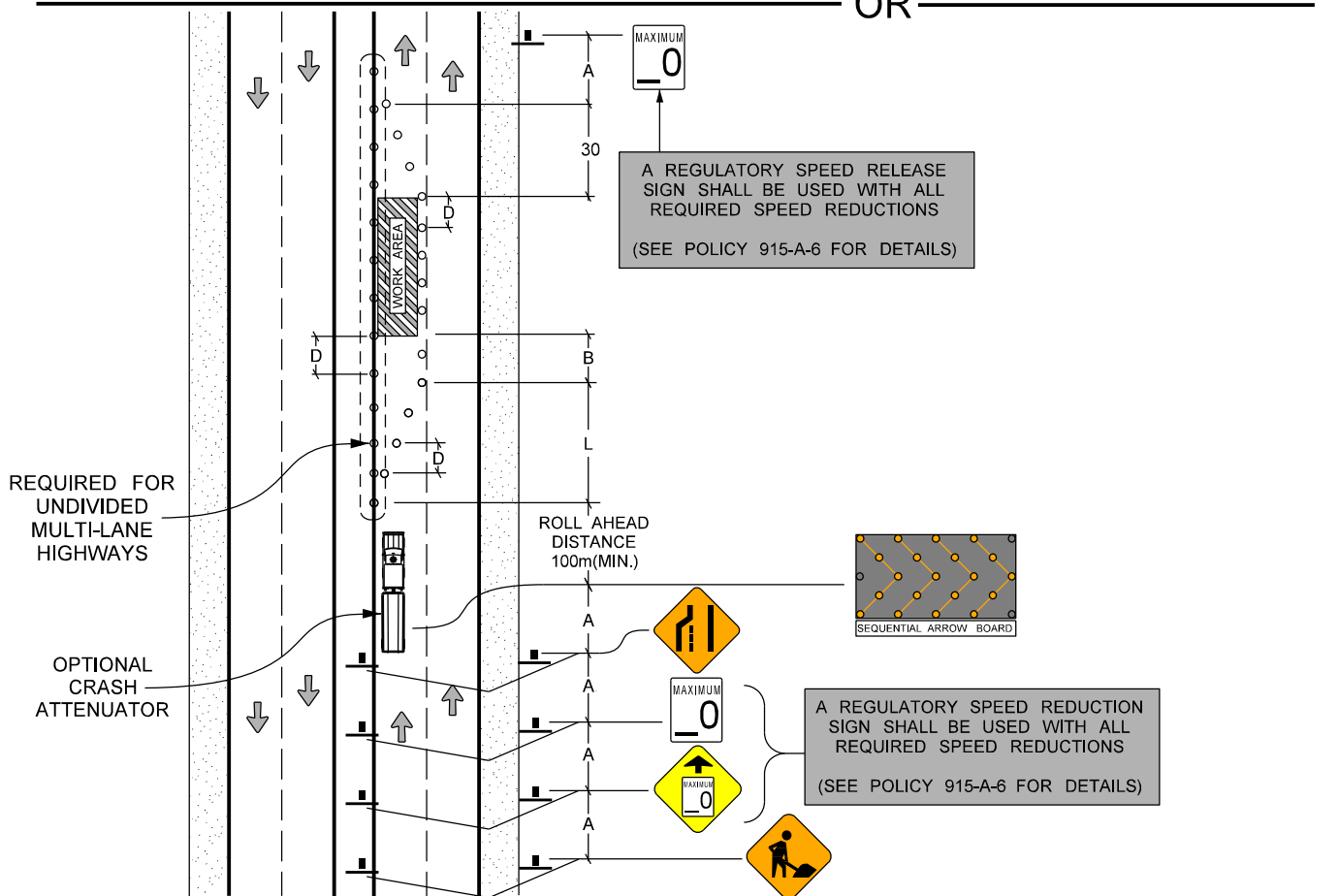

SINGLE LANE CLOSED

MULTI-LANE ROAD - LEFT LANE CLOSED

S(km/h)	A(m)	L(m)	B(m)	D(m)
50	50	60	35	15
60	50	90	45	15
70	75	120	50	15
80	100	175	55	15
90	100	200	65	20
100	150	250	70	20
110	150	250	75	20

WHERE:

- S = SPEED LIMIT
- A = SPACING BETWEEN SIGNS
- L = LENGTH OF TAPER
- B = LENGTH OF LONGITUDINAL BUFFER SPACE
- D = SPACING BETWEEN CHANNELIZATION DEVICES
- = POLYPOSTS
- = PLASTIC DRUMS

A REGULATORY SPEED RELEASE SIGN SHALL BE USED WITH ALL REQUIRED SPEED REDUCTIONS
(SEE POLICY 915-A-6 FOR DETAILS)

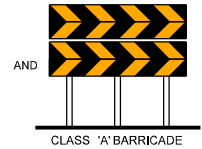
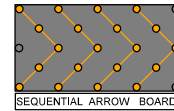

REQUIRED FOR UNDIVIDED MULTI-LANE ROADWAYS

A REGULATORY SPEED REDUCTION SIGN SHALL BE USED WITH ALL REQUIRED SPEED REDUCTIONS
(SEE POLICY 915-A-6 FOR DETAILS)

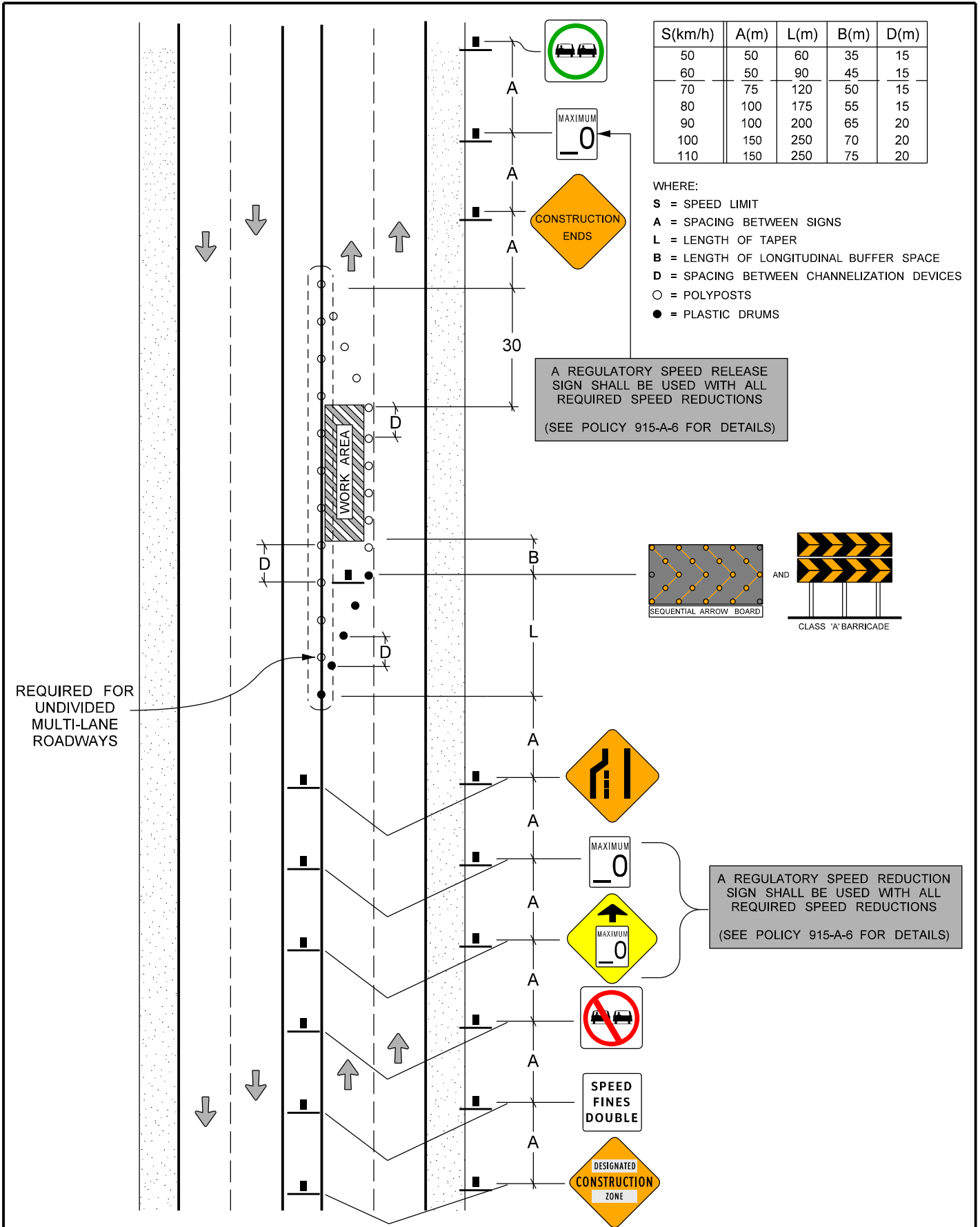

SINGLE LANE CLOSED

MULTI-LANE ROAD - RIGHT LANE CLOSED

S(km/h)	A(m)	L(m)	B(m)	D(m)
50	50	60	35	15
60	50	90	45	15
70	75	120	50	15
80	100	175	55	15
90	100	200	65	20
100	150	250	70	20
110	150	250	75	20

WHERE:

S = SPEED LIMIT

A = SPACING BETWEEN SIGNS

L = LENGTH OF TAPER

B = LENGTH OF LONGITUDINAL BUFFER SPACE

D = SPACING BETWEEN CHANNELIZATION DEVICES

O = POLYPOSTS

REQUIRED FOR
UNDIVIDED
MULTI-LANE
HIGHWAYS

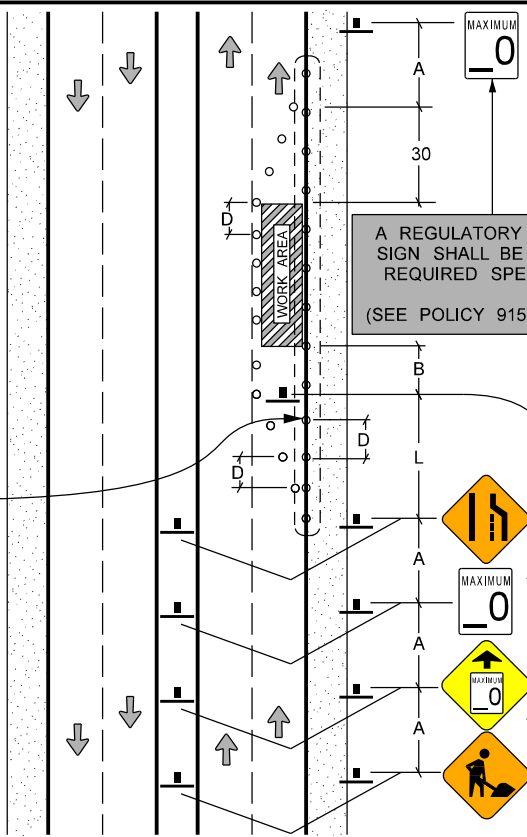

A REGULATORY SPEED RELEASE
SIGN SHALL BE USED WITH ALL
REQUIRED SPEED REDUCTIONS
(SEE POLICY 915-A-6 FOR DETAILS)

A REGULATORY SPEED REDUCTION
SIGN SHALL BE USED WITH ALL
REQUIRED SPEED REDUCTIONS
(SEE POLICY 915-A-6 FOR DETAILS)

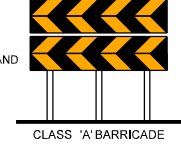
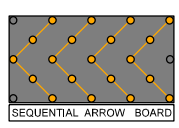

OR

REQUIRED FOR
UNDIVIDED
MULTI-LANE
HIGHWAYS

OPTIONAL
CRASH
ATTENUATOR

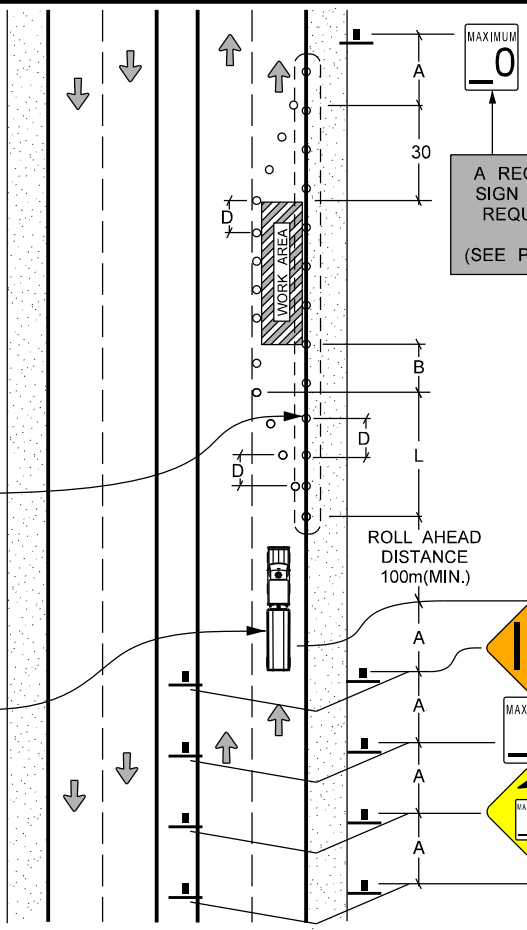

A REGULATORY SPEED RELEASE
SIGN SHALL BE USED WITH ALL
REQUIRED SPEED REDUCTIONS
(SEE POLICY 915-A-6 FOR DETAILS)

A REGULATORY SPEED REDUCTION
SIGN SHALL BE USED WITH ALL
REQUIRED SPEED REDUCTIONS
(SEE POLICY 915-A-6 FOR DETAILS)

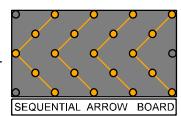

SINGLE LANE CLOSED

MULTI-LANE ROAD - RIGHT LANE CLOSED

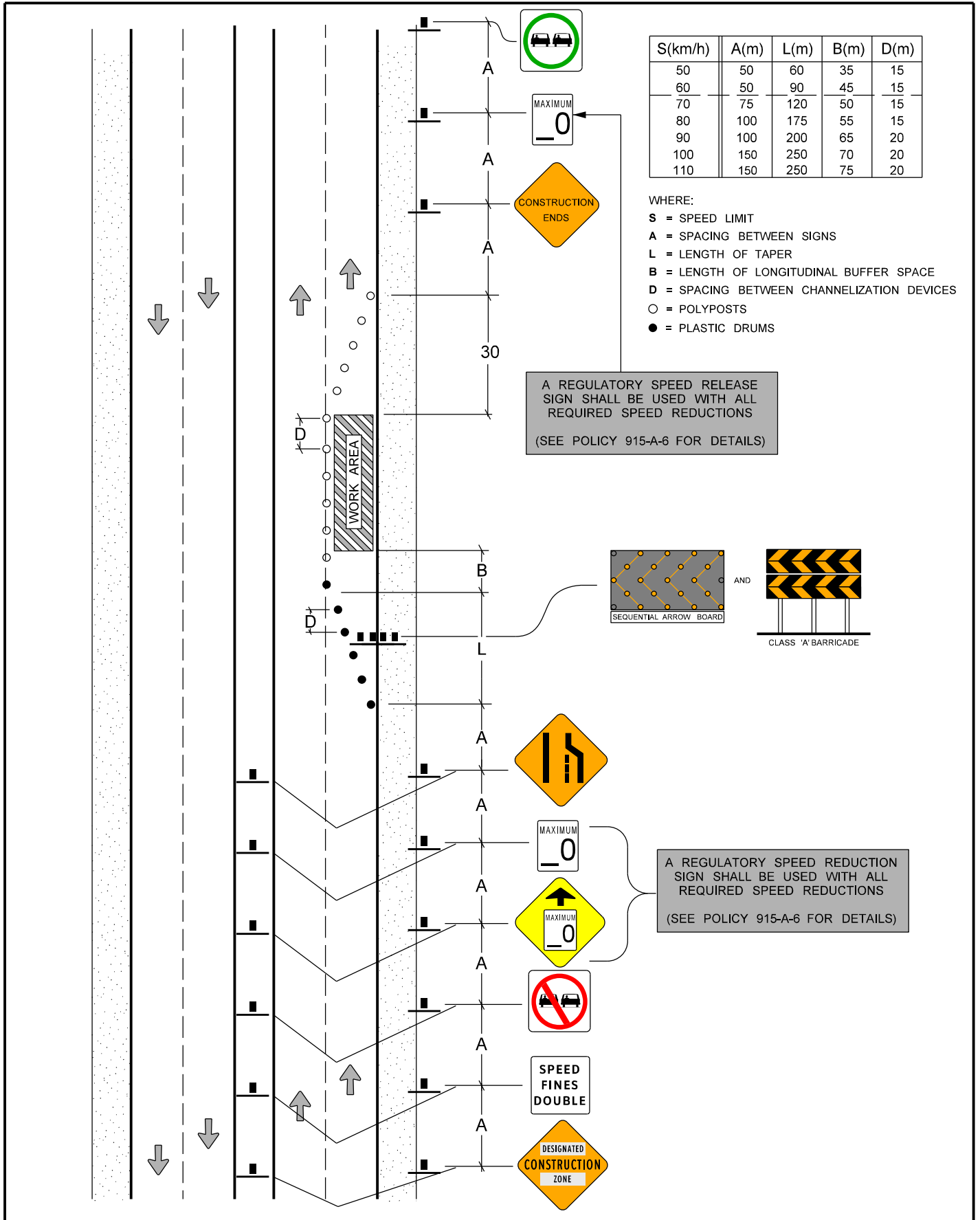

MEDIAN CROSS-OVER

AT EXISTING INTERSECTION

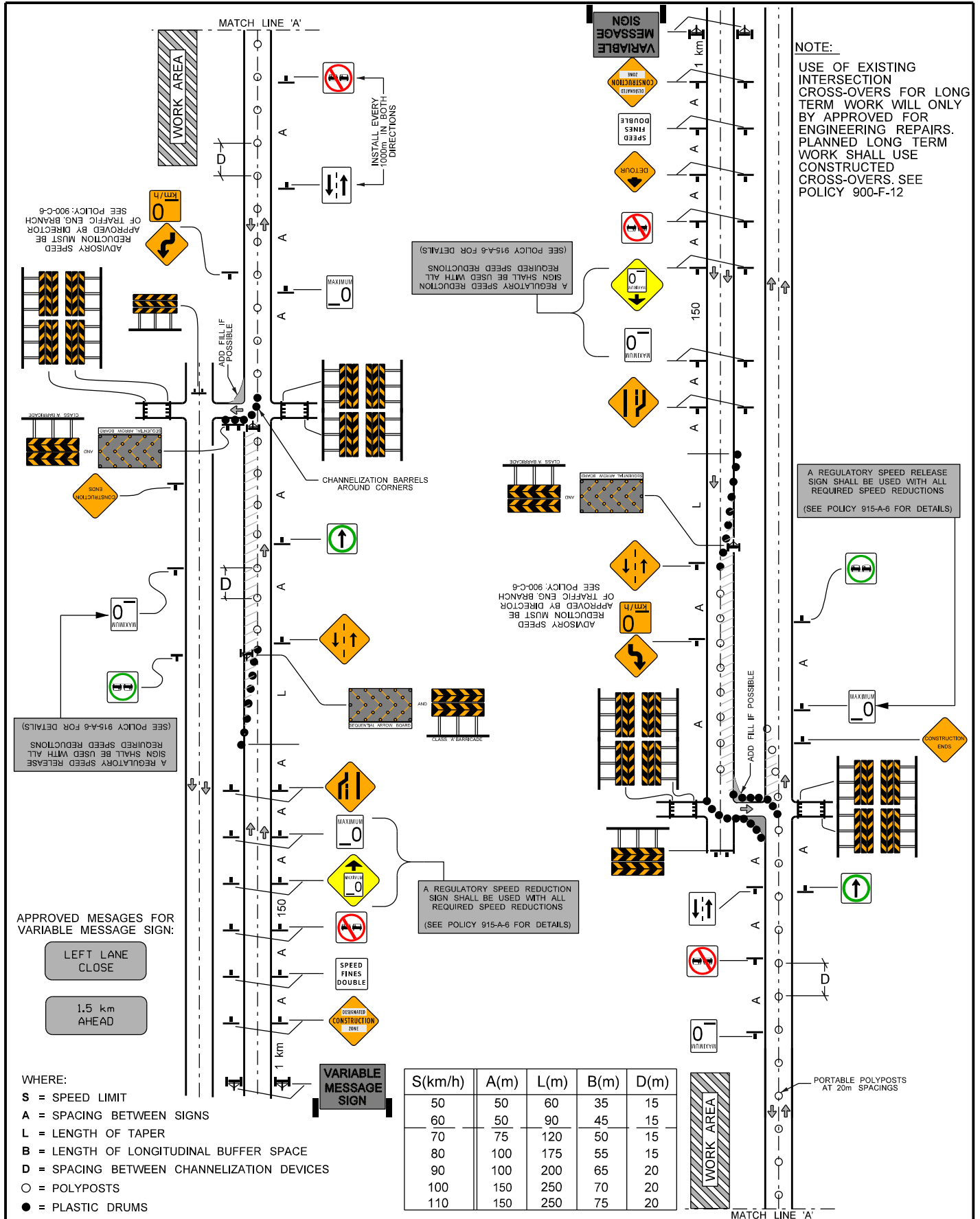

AREAS IN THE WORK ZONE

SHOOFLY DETOUR

NOTE:

1. USE IDENTICAL SIGNING IN OPPOSITE DIRECTION.
2. ILLUMINATION MAY BE REQUIRED. SEE POLICY 915-F-11.

S(km/h)	A(m)	L(m)	B(m)	D(m)
50	50	60	35	15
60	50	90	45	15
70	75	120	50	15
80	100	175	55	15
90	100	200	65	20
100	150	250	70	20
110	150	250	75	20

WHERE:

- S = SPEED LIMIT
- A = SPACING BETWEEN SIGNS
- L = LENGTH OF TAPER (SEE POLICY 900-B-12)
CHANNELIZATION BARRELS RECOMMENDED
- B = LENGTH OF LONGITUDINAL BUFFER SPACE
- D = SPACING BETWEEN DELINEATION DEVICES
- = POLYPOSTS
- = PLASTIC DRUMS

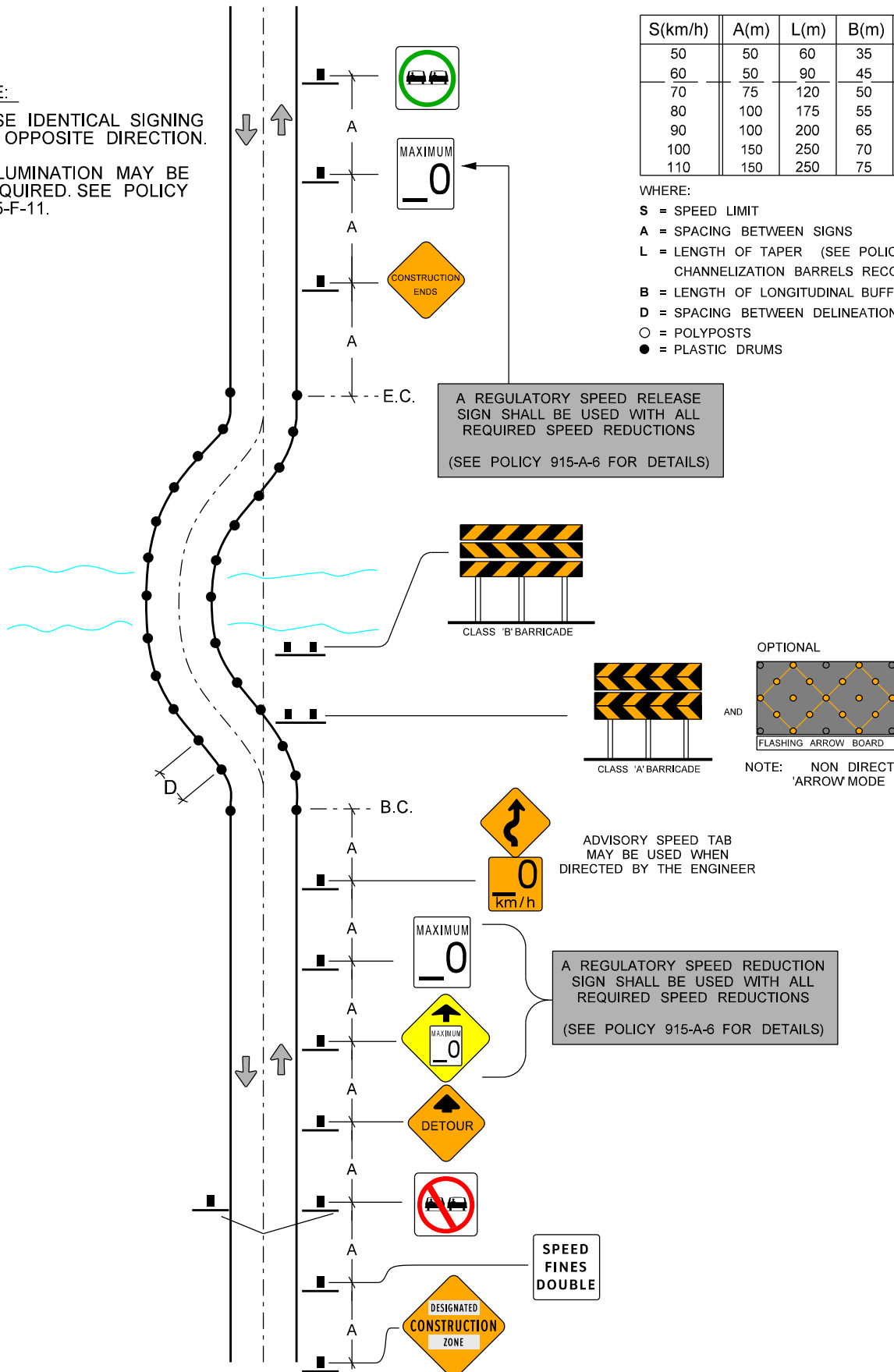

A REGULATORY SPEED RELEASE SIGN SHALL BE USED WITH ALL REQUIRED SPEED REDUCTIONS
(SEE POLICY 915-A-6 FOR DETAILS)

ADVISORY SPEED TAB MAY BE USED WHEN DIRECTED BY THE ENGINEER

A REGULATORY SPEED REDUCTION SIGN SHALL BE USED WITH ALL REQUIRED SPEED REDUCTIONS
(SEE POLICY 915-A-6 FOR DETAILS)

SPEED FINES DOUBLE

OPTIONAL

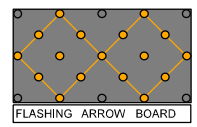

NOTE: NON DIRECTION 'ARROW MODE' ONLY

NEAR SIDE CLOSED

S(km/h)	A(m)	L(m)	B(m)	D(m)
50	50	60	35	15
60	50	90	45	15
70	75	120	50	15
80	100	175	55	15
90	100	200	65	20
100	150	250	70	20
110	150	250	75	20

WHERE:

- S = SPEED LIMIT
- A = SPACING BETWEEN SIGNS
- L = LENGTH OF TAPER (SEE POLICY 900-B-12)
CHANNELIZATION BARRELS RECOMMENDED
- B = LENGTH OF LONGITUDINAL BUFFER SPACE
- D = SPACING BETWEEN DELINEATION DEVICES
- O = POLYPOSTS

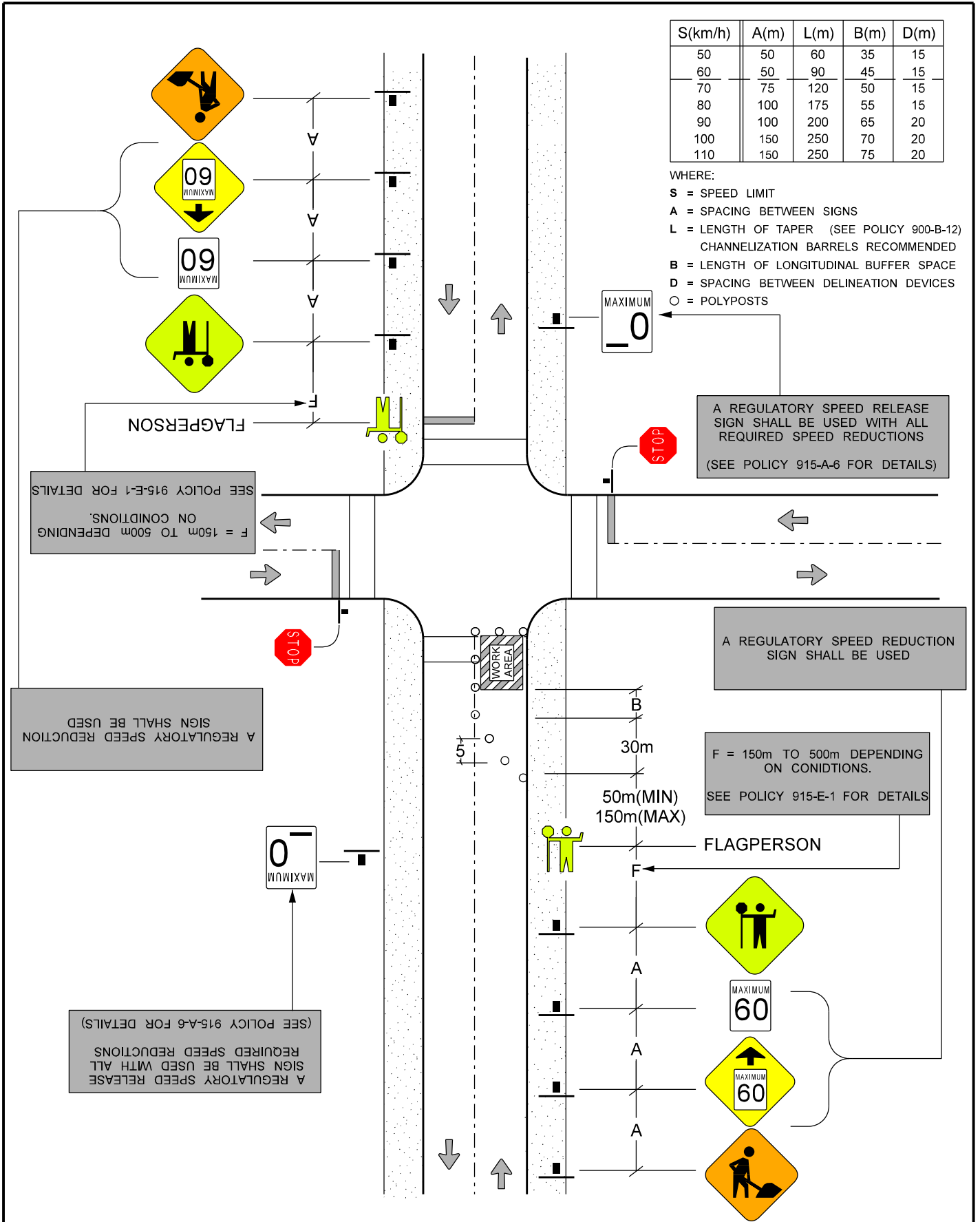

FAR SIDE CLOSED

S(km/h)	A(m)	L(m)	B(m)	D(m)
50	50	60	35	15
60	50	90	45	15
70	75	120	50	15
80	100	175	55	15
90	100	200	65	20
100	150	250	70	20
110	150	250	75	20

WHERE:

S = SPEED LIMIT

A = SPACING BETWEEN SIGNS

L = LENGTH OF TAPER (SEE POLICY 900-B-12)
CHANNELIZATION BARRELS RECOMMENDED

B = LENGTH OF LONGITUDINAL BUFFER SPACE

D = SPACING BETWEEN DELINEATION DEVICES

O = POLYPOSTS

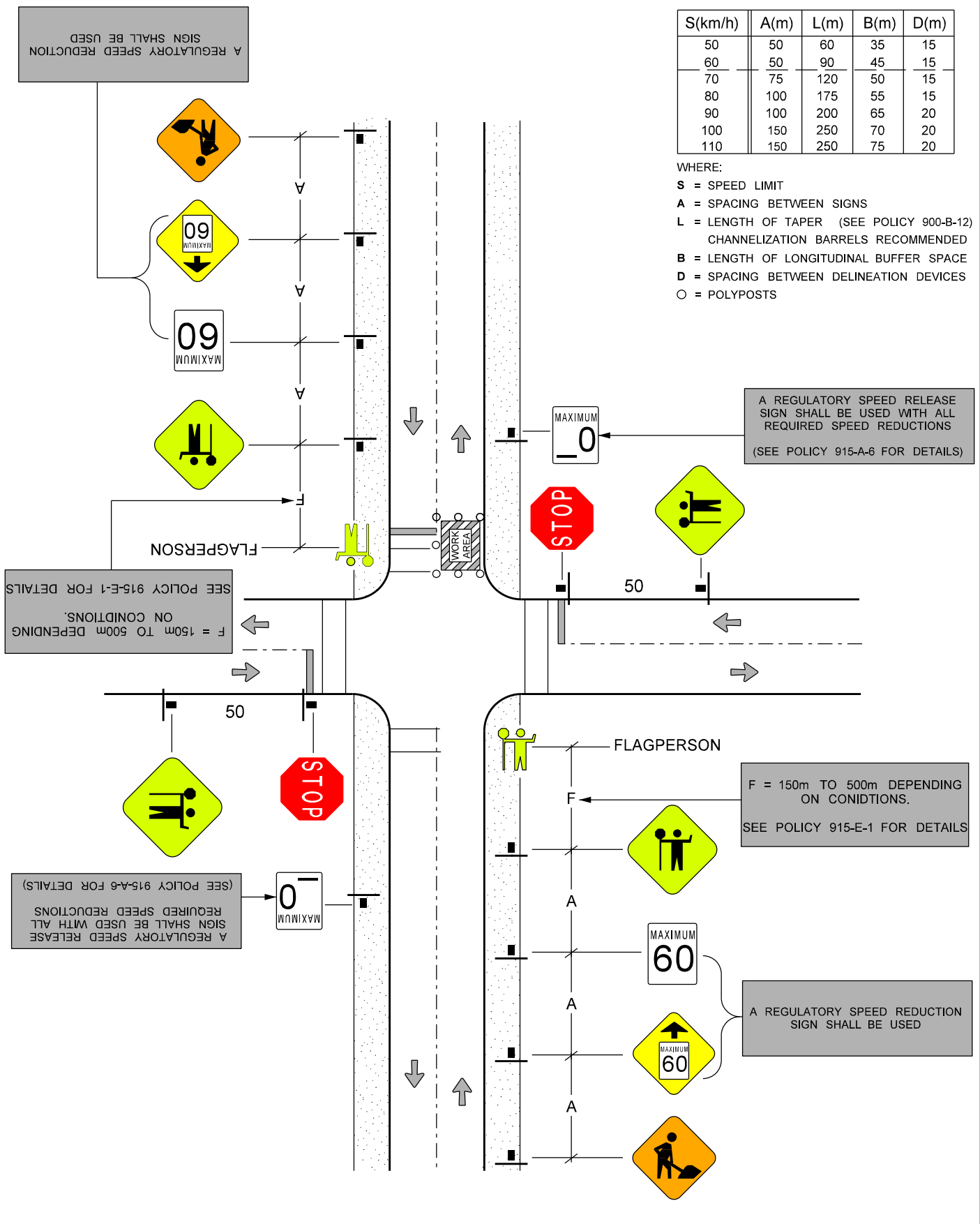

A REGULATORY SPEED REDUCTION SIGN SHALL BE USED

A REGULATORY SPEED RELEASE SIGN SHALL BE USED WITH ALL REQUIRED SPEED REDUCTIONS (SEE POLICY 915-A-6 FOR DETAILS)

SEE POLICY 915-E-1 FOR DETAILS ON CONDITIONS. F = 150m TO 500m DEPENDING ON CONDITIONS.

F = 150m TO 500m DEPENDING ON CONDITIONS. SEE POLICY 915-E-1 FOR DETAILS

A REGULATORY SPEED RELEASE SIGN SHALL BE USED WITH ALL REQUIRED SPEED REDUCTIONS (SEE POLICY 915-A-6 FOR DETAILS)

A REGULATORY SPEED REDUCTION SIGN SHALL BE USED

A REGULATORY SPEED REDUCTION SIGN SHALL BE USED

S(km/h)	A(m)	L(m)	B(m)	D(m)
50	50	60	35	15
60	50	90	45	15
70	75	120	50	15
80	100	175	55	15
90	100	200	65	20
100	150	250	70	20
110	150	250	75	20

WHERE:

S = SPEED LIMIT

A = SPACING BETWEEN SIGNS

L = LENGTH OF TAPER (SEE POLICY 900-B-12)
CHANNELIZATION BARRELS RECOMMENDED

B = LENGTH OF LONGITUDINAL BUFFER SPACE

D = SPACING BETWEEN DELINEATION DEVICES

O = POLYPOSTS

A REGULATORY SPEED RELEASE SIGN SHALL BE USED WITH ALL REQUIRED SPEED REDUCTIONS
(SEE POLICY 915-A-6 FOR DETAILS)

SEE POLICY 915-E-1 FOR DETAILS
F = 150m TO 500m DEPENDING ON CONDITIONS.

F = 150m TO 500m DEPENDING ON CONDITIONS.
SEE POLICY 915-E-1 FOR DETAILS

A REGULATORY SPEED REDUCTION SIGN SHALL BE USED

(SEE POLICY 915-A-6 FOR DETAILS)
A REGULATORY SPEED RELEASE SIGN SHALL BE USED WITH ALL REQUIRED SPEED REDUCTIONS

